

CLEANING

Use only mild soap and a damp cloth to clean the tool. Many household cleaners contain chemicals which could seriously damage the plastic. Also, do not use turpentine, lacquer or paint thinner, dry cleaning fluids or similar products. Never let any liquid get inside the tool; never immerse any part of the tool into a liquid.

IMPORTANT

In compliance with electrical authorities safety regulations, the handle of your power tool has been secured with special screws, which are designed to limit access to the electrical connections to only qualified personnel. To assure product SAFETY and RELIABILITY, repairs and maintenance (including brush inspection and replacement) must be performed by Black & Decker Service Centres or other qualified service organizations, always using Black & Decker replacement parts.

WARRANTY & SERVICE

For Details of Warranty and full list of Black & Decker Service Centres and Authorized Service Agencies, please refer to your guarantee card

BLACK & DECKER (A'SIA) PTY, LTD.
MAROONDAH HIGHWAY,
NORTH CROYDON,
VICTORIA, 3136

Form No. 741414

(NOV87-CD-1)

PRINTED IN U.S.A.

BLACK & DECKER®

INSTRUCTION MANUAL

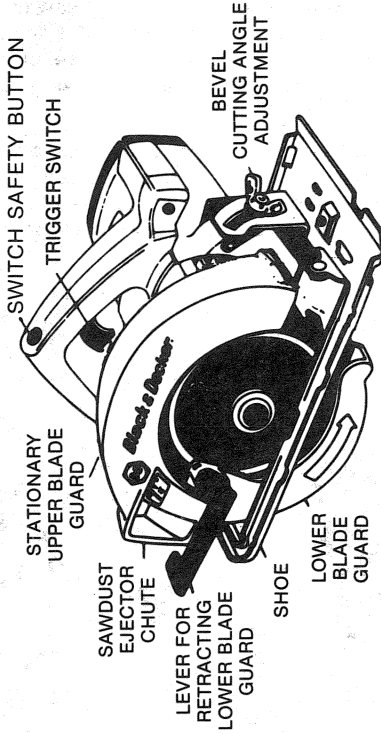

Your new Saw offers you top value and years of time-saving convenience and service. Its cutting depth is adjustable, and the saw shoe tilts for bevel sawing. For added electrical safety, it is **DOUBLE INSULATED** throughout.

Safety and proper usage are of the utmost importance with power saws! Before trying out your new saw, please read all of the safety rules and instructions carefully. Don't forget to send in the owner registration card. **THANK YOU** for buying **BLACK & DECKER!**

NO. 5738-06, 5738-46 184mm SAW

* **DOUBLE INSULATED** *

MAXIMUM CUTTING DEPTH: AT 90° — 62mm. AT 45° BEVEL — 47mm.

BEVEL ADJUSTMENT: 0° to 45°



SAFETY RULES FOR POWER TOOLS

- KEEP WORK AREA CLEAN.** Cluttered areas and benches invite accidents.
- AVOID DANGEROUS ENVIRONMENT.** Don't expose power tools to rain. Don't use power tools in damp or wet locations. And keep work area well lit.
- KEEP CHILDREN AWAY.** All visitors should be kept a safe distance from work area.
- STORE IDLE TOOLS.** When not in use, tools should be stored in dry, high or locked-up place — out of reach of children.
- DON'T FORCE TOOL.** It will do the job better and safer at the rate for which it was designed.
- USE RIGHT TOOL.** Don't force a small tool or attachment to do the job of a heavy duty tool.
- WEAR PROPER APPAREL.** No loose clothing or jewelry to get caught in moving parts. Rubber gloves and footwear are recommended when working outdoors.
- USE SAFETY GLASSES** with most tools. Also face or dust mask if cutting operation is dusty.
- DON'T ABUSE CORD.** Never carry tool by cord or yank it to disconnect from receptacle. Keep cord from heat, oil and sharp edges.

- SECURE WORK.** Use clamps or a vise to hold work. It's safer than using your hand and it frees both hands to operate tool.
- DON'T OVERREACH.** Keep proper footing and balance at all times.
- MAINTAIN TOOLS WITH CARE.** Keep tools sharp, at all times, and clean for best and safest performance. Follow instructions for lubricating and changing accessories.
- DISCONNECT TOOLS.** When not in use, before servicing; when changing accessories such as blades, bits, cutters, etc.
- REMOVE ADJUSTING KEYS AND WRENCHES.** Form habit of checking to see that keys and adjusting wrenches are removed from tool before turning it on.
- AVOID ACCIDENTAL STARTING.** Don't carry plugged-in tool with finger on switch. Be sure switch is off when plugging in.
- OUTDOOR USE EXTENSION CORDS.** When tool is used outdoors, use only extension cords suitable for use outdoors and so marked.
- DO NOT OPERATE** portable electric tools in gaseous or explosive atmospheres. Motors in these tools normally spark, and the sparks might ignite fumes.
- AVOID CONFINED SPACES.** Do not use a power tool in a confined space where body movement may be restricted.

ADDITIONAL SAW SAFETY RULES

- DISCONNECT PLUG** from power supply before changing blades, making cutting depth or cutting angle adjustments, inspecting, cleaning or when saw is not being used.
- WHEN RETRACTING** the lower blade guard, always use the retracting lever on the guard.
- KEEP GUARDS** in place and in working order NEVER TIE BACK the lower blade guard or its retracting lever.
- KEEP HANDS AWAY** from cutting area. Never reach underneath the material for any reason.
- KEEP BLADE SHARP.** Dull blades may cause the saw to swerve or stall under pressure.

- IF YOU DROP OR DAMAGE** the saw, unplug it first; then check to see if the blade and lower blade guard operate freely before resuming operations.
- NEVER REMOVE** the lower guard spring for any reason. If spring should become damaged, replace spring before attempting to use the saw.
- PERIODICALLY CHECK LOWER GUARD** for correct operation - retracting & return.
- PERIODICALLY CHECK** clamp washers, spindle bolt, spindle, and saw blade mounting hold for damage.
- NEVER** use a defective or substitute clamp washer or spindle bolt for mounting blade.
- NEVER** use blades with incorrect size mounting hole in relation to spindle size.

DOUBLE-INSULATION

Your tool is DOUBLE-INSULATED to give you added safety. This means that it is constructed throughout with TWO separate "layers" of electrical insulation or one DOUBLE thickness of insulation between you and the tool's electrical system.

Double insulated tools should be serviced only by trained personnel. We recommend that you trust even the most minor service needs to Black & Decker authorised service centres only.

NOTE: DOUBLE-INSULATION does not take the place of normal safety precautions when operating this tool. The improved insulation system is for added protection against injury resulting from a possible electrical insulation failure within the tool.

CAUTION: When servicing Double Insulated Tools, USE ONLY IDENTICAL REPLACEMENT PARTS. Replace or repair damaged cords.

EXTENSION CORD

When using the tool at a considerable distance from the power source, an extension cord of adequate size must be used for safety, and to prevent loss of power and over-heating. Use the table below to determine minimum wire size required.

Before using cords, inspect them for loose or exposed wires and damaged insulation. Make any needed repairs or replacement before using your power tool.

Rated Amps of Tool	Extension Cord Length			
	0-25m	25-35m	35-50m	50-75m
1-5 Amp	24/0.20	24/0.20	32/0.20	30/0.25
5-7.5 Amp	24/0.20	32/0.20	30/0.25	—
7.5-10 Amp	32/0.20	30/0.25	—	—

RECOMMENDED MINIMUM SIZES OF EXTENSION CORDS

MOTOR

Your Black & Decker tool is powered by a B & D-built motor. Be sure your power supply agrees with the nameplate marking.

Volts 50/60 Hz or "AC only" means your tool must be operated only with alternating current and never with direct current. Volts DC-60Hz or AC/DC means your tool may be operated with either alternating or direct current.

Voltage variation of more than 10% will cause loss of power and overheating. All B&D tools are factory tested; if this tool does not operate, check the power supply.

LUBRICATION

Self lubricating bearings are used in the tool and periodic relubrication is not required. However, it is recommended that, once a year, you take or send the tool to a B&D Service Center for a thorough cleaning, inspection and lubrication of the gear case. Service Center addresses are shown on the owner registration card packed with your tool.

ATTACHING & REMOVING BLADES

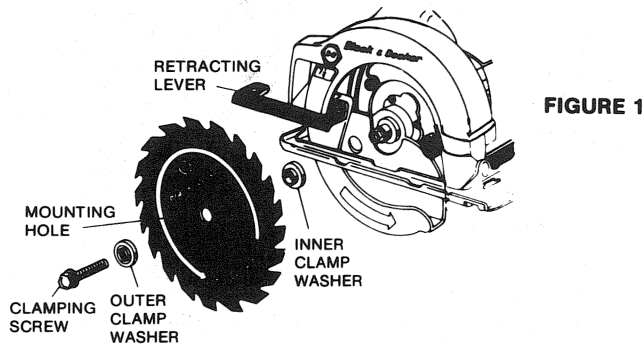

FIGURE 1

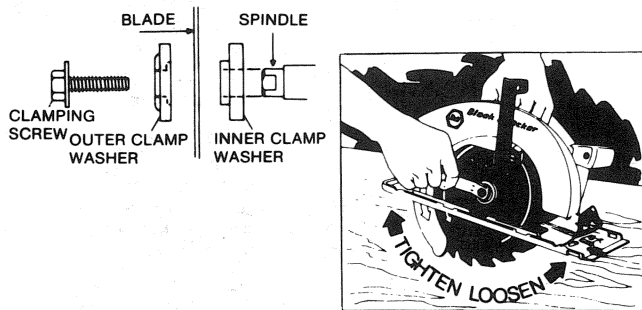

FIGURE 2

1. BE SURE SAW IS DISCONNECTED FROM POWER SUPPLY!

2. To remove blade clamping screw (Fig. 1):

—a. ON NEW SAWS (without blade attached). Turn screw counter-clockwise with blade wrench provided. If screw does not loosen easily from spindle, tap the outer end of the wrench sharply in a counter-clockwise direction with a piece of wood to "free" the screw threads. Remove screw and outer clamp washer.

—b. ON SAWS WITH BLADE ATTACHED. Using the retracting lever, retract the lower blade guard and place the Saw on a piece of scrap lumber as shown in Figure 2. Press down on the Saw so that the blade teeth dig slightly into the lumber and prevent the blade from turning. Then, with the blade wrench provided, turn the clamping screw counter-clockwise and remove the screw and outer clamp washer. Disengage the blade teeth from the lumber, and with the lower blade guard still retracted, lift off the blade.

3. To attach the blade: Place inner clamp washer on spindle if previously removed. Retract lower blade guard and place blade over inner clamp washer with printed side of blade out (teeth at bottom of blade pointing forward). Fit outer clamp washer onto spindle . . . "flats" on the outer washer must mesh with the "flats" on the spindle. Thread on clamping screw firmly by hand to hold washers in position. Place Saw on piece of scrap lumber as shown in Figure 2 and press down on the Saw so that blade teeth dig slightly into wood and prevent the blade from turning. Tighten clamping screw (clockwise) firmly with the blade wrench.

NOTE: An alternate way to keep the blade from turning, when tightening or loosening the blade screw, is to hold a large nail through the hole in the blade and against the forward part of the shoe. Rest the nail on top of the shoe when tightening, against the bottom when loosening. **CAUTION:** Remove nail before connecting plug.

CUTTING DEPTH ADJUSTMENT

DISCONNECT PLUG FROM POWER SUPPLY BEFORE MAKING THIS OR ANY OTHER ADJUSTMENT.

When cutting thin panels (10mm or less), set the depth adjustment so that no more than one tooth of the blade will project below the material to be cut. This distance is from the tip of the tooth to the bottom of the gullet in front of it. When cutting heavier timber, set the depth adjustment for maximum protrusion of the blade below the work.

To adjust the cutting depth:

1. BE SURE THE SAW IS DISCONNECTED FROM THE POWER SUPPLY!
2. Place the saw in the position shown in Figure 3 and loosen depth adjustment wing nut "A".
3. Place a scrap piece of the material to be cut along the side of the blade as shown. Raise or lower the shoe until the blade projects from the shoe the desired distance. Retighten wing nut "A" firmly.

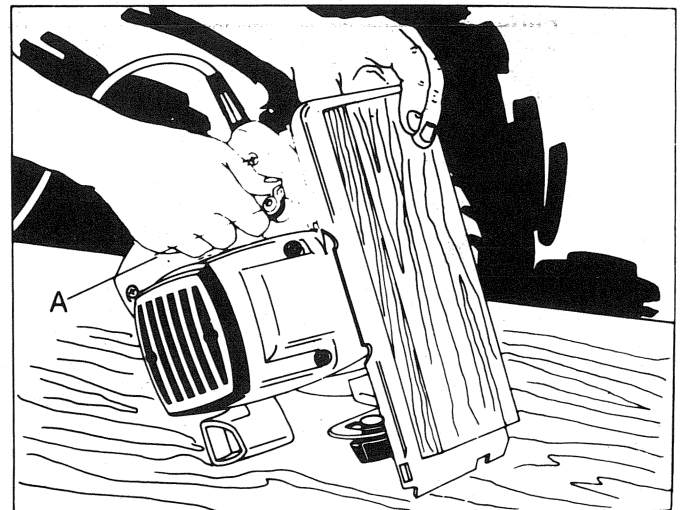

FIGURE 3

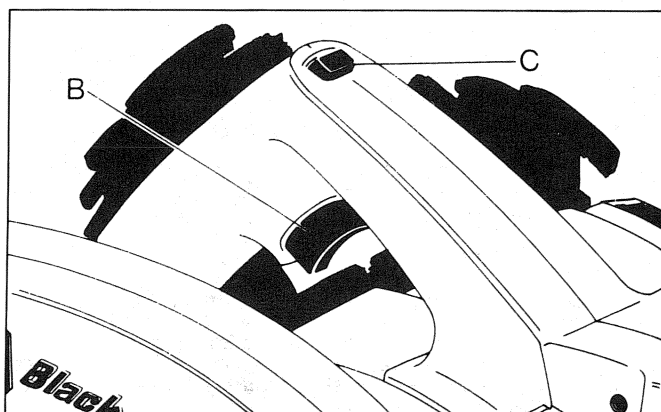

FIGURE 4

SWITCH

To prevent the Trigger Switch "B" (Figure 4) from being accidentally depressed, a Switch Locking Button "C" is provided on the top of the main handle as a safety feature.

TO TURN SAW "ON", press in the locking button "C" with your thumb, and hold it in momentarily, while you depress the trigger switch "B". Depressing the trigger turns the tool "ON".

TO TURN TOOL "OFF", merely release the trigger. The locking button will snap forward and lock the trigger "OFF".

NEVER use any make-shift device to lock the switch in the "ON" position.

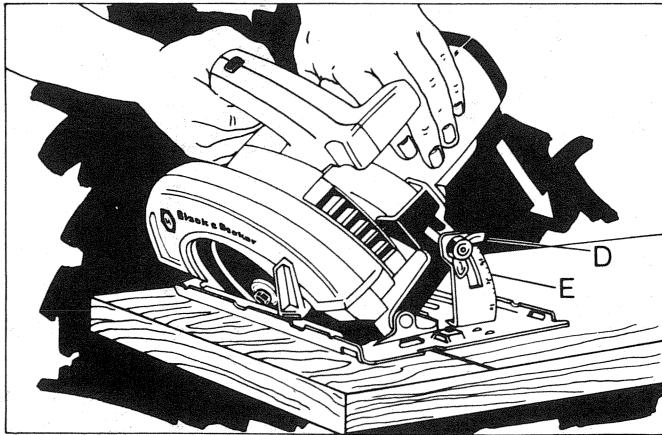

FIGURE 5

BEVEL ANGLE ADJUSTMENT

DISCONNECT THE SAW FROM THE POWER SUPPLY BY PULLING THE PLUG, BEFORE MAKING THIS, OR ANY OTHER ADJUSTMENT! On the front of the saw is a bevel angle adjustment device (Figure 5) consisting of calibrated quadrant "E" and a wing nut "D". To set the saw for a bevel cut, loosen wing nut and tilt shoe to angle desired. Retighten wing nut firmly.

CAUTION:When making bevel cuts, place one hand on the motor housing as shown in Figure 5. Exert only enough pressure in the direction of the arrow to keep the saw shoe flat on the work. This will insure an accurate bevel cutting angle and help prevent the blade from binding in the cut.

GUIDE EDGES

A notch on the front of the saw shoe has two guide edges (Figure 7) — one for vertical cutting, and one for 45° bevel cutting. These edges enable you to guide the saw along penciled lines, and the edges line up with the left (inner) side of the saw blade. This makes the slot or "kerf" cut by the moving blade fall to the right of the guide mark. Guide along the

GUIDE ALONG PENCILLED CUTTING LINE SO KERF FALLS IN WASTE STOCK

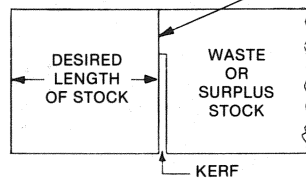

FIGURE 6

pencilled cutting line so that the kerf falls into the waste or surplus material — See Figure 6.

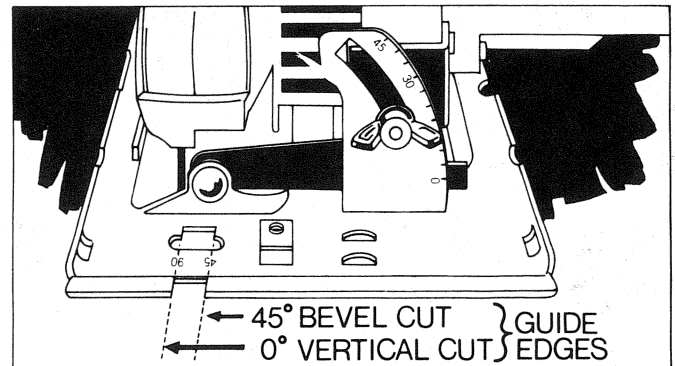

FIGURE 7

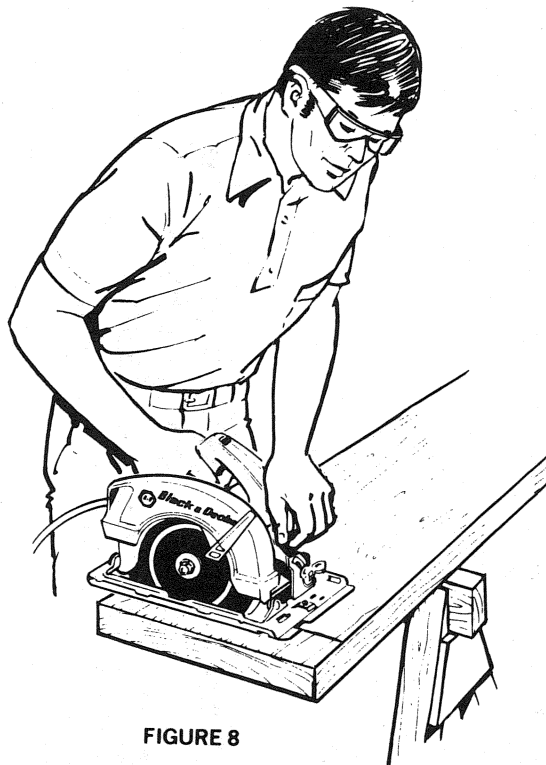
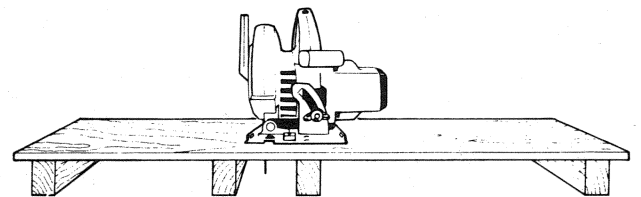

FIGURE 8

OPERATION

Figure 8 shows proper sawing position. Note that hands are kept away from cutting area, safety glasses are worn, power cord is kept clear of cutting area, and that clothing is not loose to the point where it might get caught in moving parts.



TO AVOID KICKBACK, DO SUPPORT BOARD OF PANEL NEAR THE CUT.

FIGURE 9

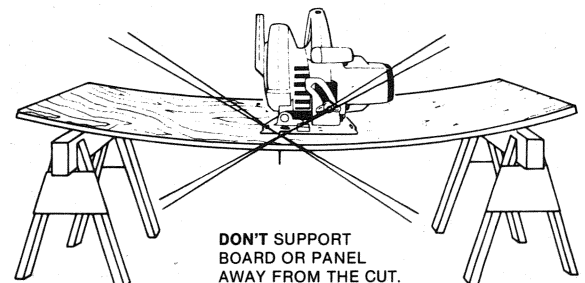

DON'T SUPPORT BOARD OR PANEL AWAY FROM THE CUT.

OPERATION

ALWAYS DISCONNECT SAW BEFORE MAKING ANY ADJUSTMENTS! Place the work with its "good" side—the one on which appearance is most important—down. The saw cuts upward, so any splintering will be on the work face that is up when you saw it.

Support the work so that the cut will be on your right. Place the wider portion of the saw shoe on that part of the work piece which is solidly supported, not on the section that will fall off when the cut is made. As examples, Figure 10 illustrates the RIGHT way to cut off the end of a board, and Figure 11 the WRONG way. If the work is short or small, clamp it down. Don't try to hold short pieces by hand!

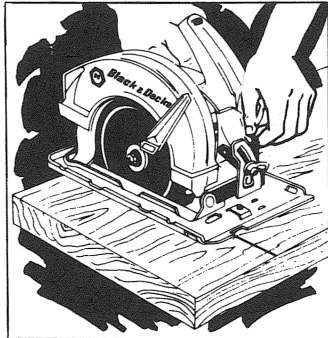

FIG. 10 — RIGHT

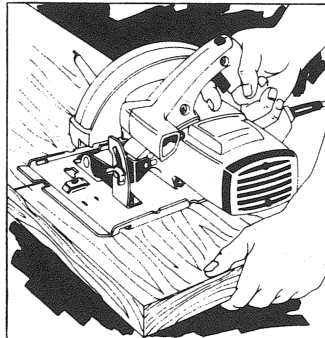

FIG. 11 — WRONG

Draw the required guide lines. Then rest the front of the saw shoe on the work with the guide edge lined up with the drawn guide line. Before starting the motor, push the blade lightly against the edge of the work and then back it off about 1/4". Now, start the motor, and when the blade gains full speed, push the saw forward and begin sawing. As you begin cutting, the lower blade guard will automatically begin to telescope into the upper blade guard. This telescoping action will continue as you advance the saw until it reaches the position in Figure 10.

Push the saw forward at a speed which allows the blade to cut without laboring. Hardness and toughness can vary even in the same piece of material, and a knotty or damp section can put a heavy load on the saw. When this happens, push the saw more slowly, but hard enough to keep it working without much decrease in speed. Forcing it beyond this makes for rough cuts, inaccuracy and overheating of the motor.

Should your cut begin to go off the line, don't try to force the saw back on. Release trigger and allow blade to come to a complete stop. Then you can withdraw the saw, sight anew, and start a new cut a trifle inside the wrong one. In any event, withdraw the saw if you must shift the cut. Forcing a correction inside the cut can stall the saw and perhaps spoil the work. **IF SAW STALLS, RELEASE THE TRIGGER, BACK THE SAW UNTIL IT IS LOOSE. BE SURE BLADE IS STRAIGHT IN THE CUT BEFORE RESTARTING.**

As you finish a cut, release the trigger and allow the blade to stop before lifting the saw from the work. As you lift the saw the spring-tensioned telescoping guard will automatically close under the saw. Remember the blade is exposed until this occurs; **never reach under the work for any reason whatsoever.** When you have to retract the telescoping guard manually (as is necessary for starting pocket cuts) always use the retracting lever.

POCKET CUTTING

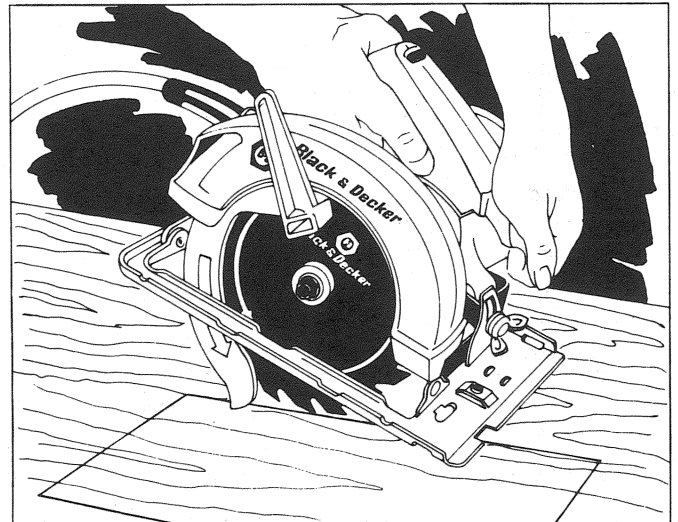







FIGURE 12

DISCONNECT SAW FROM POWER SUPPLY BEFORE MAKING CUTTING DEPTH ADJUSTMENT! Adjust saw shoe so blade cuts at desired depth. Tilt saw forward and rest front of shoe on material to be cut. Using the retracting lever, retract blade guard to an upward position. Lower rear of shoe until blade teeth almost touch cutting line. Now release the blade guard and its contact with the work will keep it in position to open freely as you start the cut (Figure 12). Start the motor and gradually lower the saw until its shoe rests flat on the material to be cut. Advance saw along cutting line until cut is completed. Release trigger and allow blade to stop completely before withdrawing the blade from the material. When starting each new cut, repeat as above. **Never tie the blade guard in a raised position.**

BLACK & DECKER CIRCULAR SAW BLADES

TYPE OF BLADE	TOOTH SHAPE
<p>COMBINATION Chisel tooth configuration means this blade is the fastest cutting blade in our line. Specifically designed for general-purpose ripping and cross-cutting where the finish of the cut is not critical.</p>	
<p>MASTER COMBINATION General-purpose blade designed for ripping, cutting off and mitering wood where a fine, smooth cut is needed. No sanding is necessary.</p>	
<p>FRAMING/RIP An all-purpose blade for smooth, fast cutting in any direction. Rips, crosscuts, miters, etc. Gives especially fast, smooth finishes when cutting with the grain of both soft and hard woods.</p>	
<p>HOLLOW GROUND PLANER Specially ground for satin-smooth finish cuts (cross-cuts, rips and miters) in all solid woods. A professional quality blade for use in cabinet work, furniture, etc. Specifically designed to make extremely smooth cuts in wood.</p>	
<p>FLOORING For use where nails or other metal objects may be encountered, such as cutting reclaimed lumber, flooring, opening crates. Allows crosscuts as well as miters.</p>	
<p>HOLLOW GROUND PLYWOOD Special taper grinding on the sides of this thin-rim blade gives an absolutely smooth cut in plywood, veneers and laminates, etc. Can be used in crosscutting and mitering for a professional finish on all types of cabinet work.</p>	
<p>CROSS-CUT Specifically designed for smooth, fast cutting cross the grain of both hard and soft woods where finish is an important factor. May also be used for rip and crosscuts on extremely hard woods.</p>	