



DEWALT®

instruction manual

KEEP THIS BOOKLET WITH THE SAW

Serial Number _____

Model and serial number may be found on the nameplate.

You should record both model and serial number in a safe place for future use.

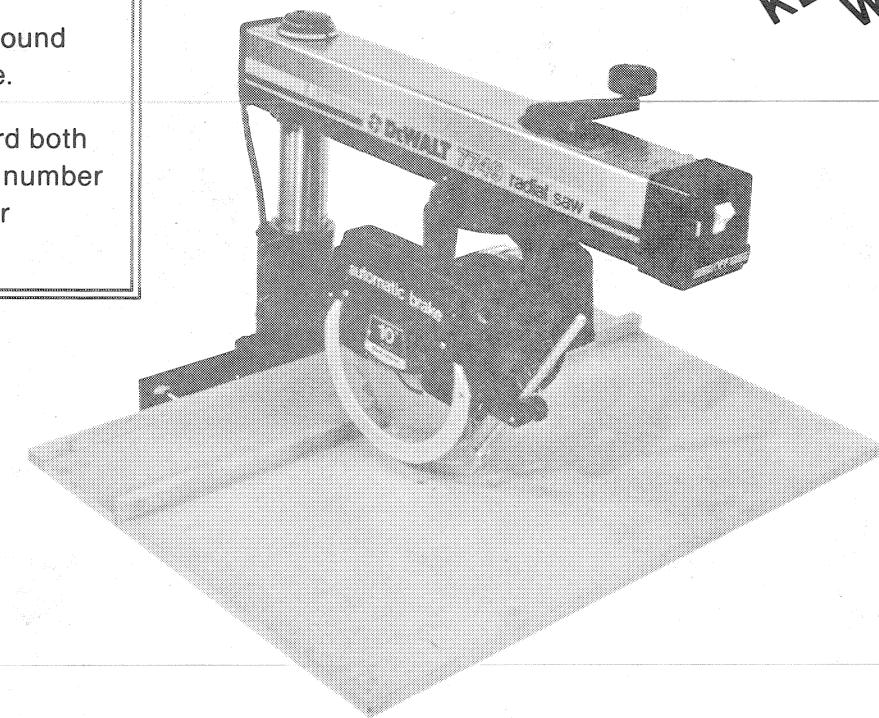

WARNING: FOR YOUR OWN SAFETY, READ THIS MANUAL BEFORE OPERATING TOOL. REVIEW SAFETY RULES AND OPERATING INSTRUCTIONS FREQUENTLY.

HOME USE WARRANTY (A Limited Warranty)

Black & Decker warrants this product for five years except for all motor components which are warranted for one year. We will repair without charge, any defects due to faulty material or workmanship. Please return the complete unit, transportation prepaid, to any Black & Decker Service Center or Authorized DeWalt Service Station listed under "Tools Electric" in the yellow pages. This warranty does not apply to accessories. This warranty gives you specific legal rights and you may have other rights which vary from state to state. Should you have any questions, contact your nearest Black & Decker Service Center Manager.

COMMERCIAL USE WARRANTY (A Limited Warranty)

Black & Decker warrants this product for one year from date of purchase. We will repair without charge, any defects due to faulty material or workmanship. Please return the complete unit, transportation prepaid, to any Black & Decker Service Center or Authorized DeWalt Service Station listed under "Tools Electric" in the yellow pages. This warranty does not apply to accessories. This warranty gives you specific legal rights and you may have other rights which vary from state to state. Should you have any questions, contact your nearest Black & Decker Service Center Manager.

IMPORTANT!

IMPORTANT!

To assure product RELIABILITY, repairs, maintenance and adjustment, should be performed by Black & Decker Service Centers or DeWALT Authorized Service Centers, always using DeWALT replacement parts.



Division of Black & Decker (U.S.) Inc.
U.S. Power Tools Group, 10 North Park Drive, P.O. Box 798, Hunt Valley, MD 21030-0798
Form No. 230222-04 (JUL86-CD)

Printed in U.S.A.

This booklet is provided for your convenience in the use and care of your new DeWalt Saw. These instructions include operation, usage, precautions, preventive maintenance, maintenance and other pertinent data to assist you in assuring long life and dependable service from your saw.

7739 & 7749
10" RADIAL ARM SAW
Cat. Nos. 7739 & 7749

INDEX

Unpacking, Setup, and Specifications 2-3
 Electrical Connection and Grounding 3-4
 Rules for Safer, Operation and Maintenance 4
 Machine Controls 5
 Alignment 6-12
 Operating Instructions 13-16
 Troubleshooting Guides 17, 18, & 21
 Accessories 19-20

Specifications	7739	7749
Motor	120V, 1 ph.	120V, 1 ph.
Motor Rating Develops	2 HP	2-1/2 HP
Full Load Speed—60 cy. AC	3450 RPM	3450 RPM
Blade Guards		
(Upper and lower)	254 mm (10")	254 mm (10")
Standard Blade	254 mm (10")	254 mm (10")
Arbor Size	15.9 X 38.1 mm	15.9 X 38.1 mm
	5/8" X 1-1/2" long	5/8" X 1-1/2" long
Maximum Depth of Cut	73 mm (2-15/16")	73 mm (2-15/16")
Maximum Depth of Cut at 45° Bevel	54 mm (2-1/8")	54 mm (2-1/8")
Maximum Depth of Cut at 45° Bevel with Lower Guards	41 mm (1-5/8")	41 mm (1-5/8")
Cross Cut Capacity—1" stock	343 mm (13-1/2")	343 mm (13-1/2")
Spindle Dado Cap.—Width	20.6 mm (13/16")	20.6 mm (13/16")
Ripping Capacity—Width	635 mm (25")	635 mm (25")
Net Weight approx.	57.6 kg (127 lbs.)	58.5 kg (129 lbs.)

NOTES

UNPACKING AND SET-UP INSTRUCTIONS

. . . you can easily set up your DeWalt Radial Saw, America's most popular power tool. Handling is minimized because every machine is assembled and job-tested at the factory, then partially knocked down for shipment to you. The only tools required are the wrenches furnished with the machine and screwdrivers from your tool box.
 So that your new Radial Saw may be placed in operation just as soon as assembled, all electrical connections have been made at the factory to operate on proper power supply.—See Parts Bulletin for electric specifications.

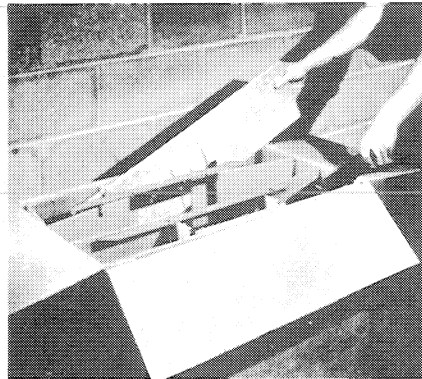

1. Remove table boards, metal cleats and legs, if provided, from carton.

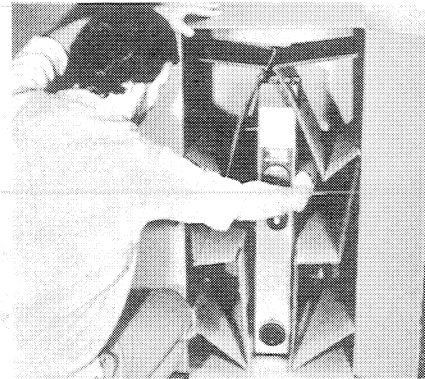

2. Remove guard box, tip carton on end and remove machine. Set machine upright.

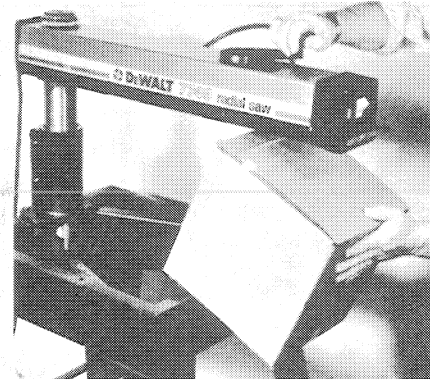

3. Raise arm assembly to free carton containing motor by turning elevating handle counter-clockwise. Remove motor from box. Unpack guard box and hardware bag.

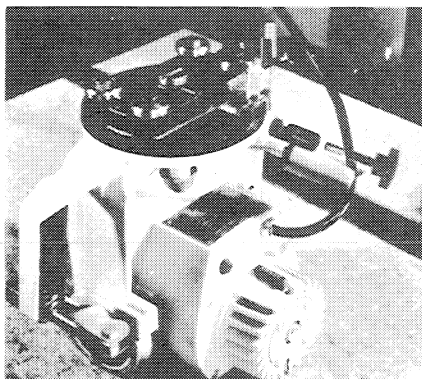

4. Insert slug and short threaded knob into Rip Lock and install into Roller Head as shown.

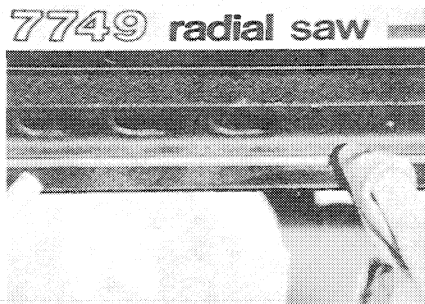

5. To install motor assembly, first, back out the two set screws (A, Fig. 6) on end cap sufficiently to allow the paddle to be lifted and held in a position to remove the end cap mounting screws. Remove the two mounting screws, lift the end cap from its mounted position and place on top of the shroud being careful not to disconnect or damage wiring. Wipe arm tracks with a clean cloth prior to installation of motor assembly.

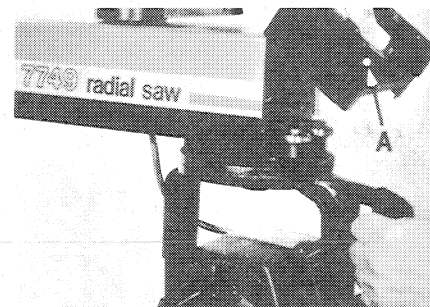

6. Carefully slide the motor assembly into arm. Replace the end cap and tighten mounting screws securely. Check to be sure the shroud is assembled properly in the front and rear end caps. Without "Power" pull the motor assembly forward firmly against the front end cap. The end cap should stop the motor assembly with no apparent movement. If not, check the front end cap mounting screws and tighten these screws securely. Retighten the set screws on side of end cap until flush with side of end cap. Be sure there is no interference between paddle and set screws. Paddle must move freely.

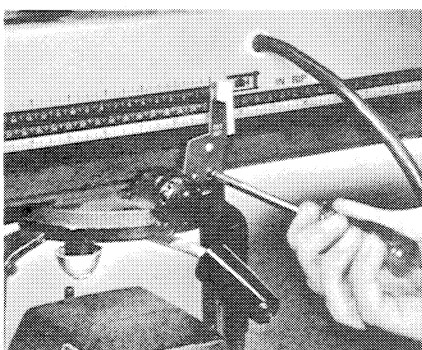

7. Install rip pointers with #6-32 x 1/4" long screws provided. Adjust both pointers to upright position and tighten screws.

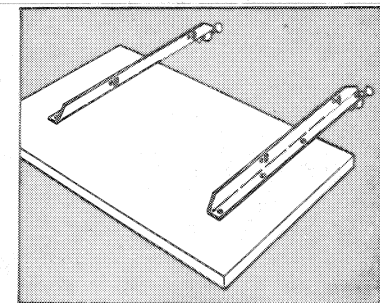

8. Assemble cleats on fixed board with the six (6) screws provided in the hardware bag. **DO NOT TIGHTEN SCREWS ALL THE WAY DOWN.** Insert the 5/16-18 x 1 1/4 hex head screw & (2) 5/16-18 thin hex nuts from hardware bag into table frame. (See Fig. A page 9).

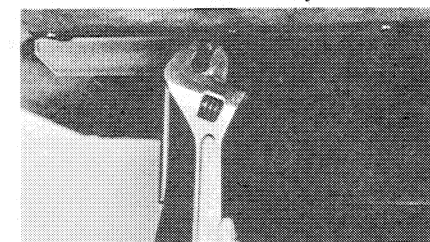

9. Insert 4 square bolts from inside of frame through table cleats. Attach flat washers, lockwashers and nuts and tighten finger tight. Then tighten the 10 screws securely.

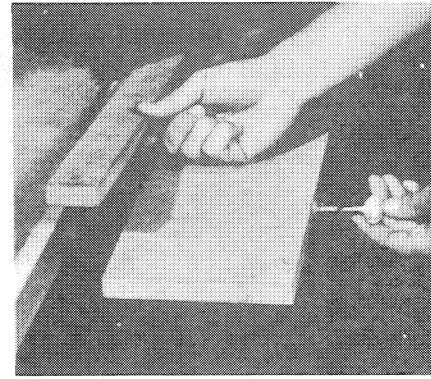

10. Assemble guide fence and spacer boards, thread thumb screw into bracket. Insert bracket into the slot provided in rear of cleats. Hold the eyelet in place and turn the thumb screw until it "pops" into place.

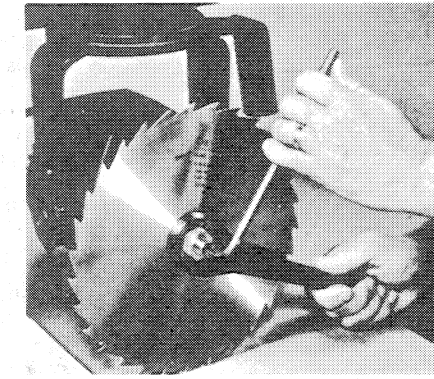

11. Place spacer on shaft, then place saw blade (with direction arrow as shown) between collars (recessed side against blade). Tighten arbor nut securely with both wrenches (left-hand threads).

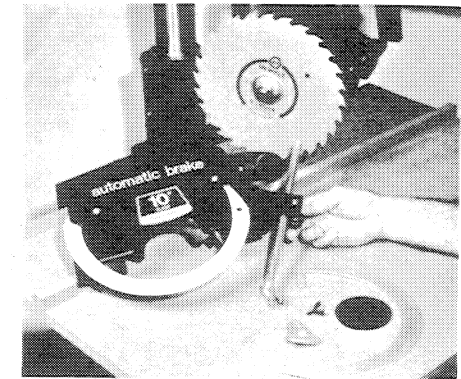

12. Assemble anti-kickback, locking knob, dust spout and lower guard except front inner retainer and inner ring per the Parts List diagram.

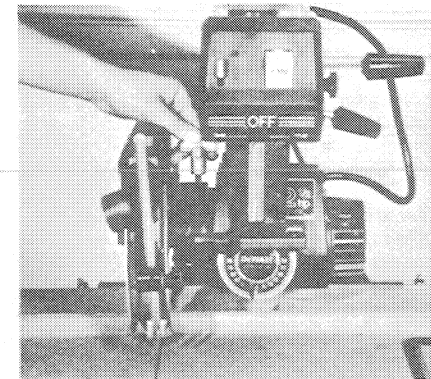

13. Place guard over blade tilting guard slightly to clear the arbor shaft. Seat guard on motor so that the guard rides in the circular slot in the motor and the motor stud goes through the hole in the guard. Secure with the wingnut. Place the inner ring under the motor and hook it over the rear retainer and the front boss. Install the front inside retainer with the thumbscrew and tighten securely. Note that this step must be repeated in reverse order to gain access to the blade for removing it. Place the key in the endcap but do not press the ON button. Your machine has been partially adjusted and aligned at the factory; before operating the saw perform the adjustments and alignments marked with an asterisk (*).

CAUTION

1. Securely fasten the table frame to the Leg Stand or a sturdy work bench using the holes provided. Use sturdy outrigger supports if any table extensions are attached to the saw.
2. Shim under front legs to keep saw carriage from creeping forward.
3. Read, understand and always practice the cautions and operating instructions contained within this manual.

ELECTRICAL CONNECTIONS AND GROUNDING

This tool should be grounded while in use to protect the operator from electric shock.

We recommend that you NEVER disassemble the tool or try to do any rewiring in the electrical system. Any such repairs should be performed only by B&D Service Centers or other qualified service organizations. Should you be determined to make a repair yourself, remember that the green colored wire is the "grounding" wire. Never connect this green wire to a "live" terminal.

1. **Cord-Connected Tools:** In the event of a malfunction or breakdown, grounding provides a path of least resistance for electric current to reduce the risk of electric shock. This tool is equipped with an electric cord having an equipment-grounding conductor and a grounding plug. The plug must be plugged into a matching outlet that is properly installed and grounded in accordance with all local codes and ordinances. Do not modify the plug provided — if it will not fit the outlet, have the proper outlet installed by a qualified electrician. Improper connection of the equipment-grounding conductor can result in a risk of electric shock. The conductor with insulation having an outer surface that is green with or without yellow stripes is the equipment-grounding conductor. If repair or replacement of the electric cord or plug is necessary, do not connect the equipment-grounding conductor to a live ter-

ACCESSORIES

Recommended Blades and Accessories for your Radial Arm Saw are stocked by your B&D Dealer. These accessories are listed and described in the B&D DeWalt Catalog and on pages 19 and 20. CAUTION—The use of any other accessory might be hazardous.

minal. Check with a qualified electrician or serviceman if the grounding instructions are not completely understood, or if in doubt as to whether the tool is properly grounded. Use only 3-wire extension cords that have 3-prong grounding plugs and 3-pole receptacles that accept the tool's plug. Repair or replace damaged or worn cord immediately.

1A. Grounded, cord-connected tools intended for use on a supply circuit having a nominal rating less than 150 volts. This tool is intended for use on a circuit that has an outlet that looks like the one illustrated in Sketch A. The tool has a grounding plug that looks like the plug illustrated in Sketch A. A temporary adapter, which looks like the adapter illustrated in Sketches B and C, may be used to connect this plug to a 2-pole receptacle as shown in Sketch B if a properly grounded outlet is not available. The temporary adapter should be used only until a properly grounded outlet can be installed by a qualified electrician. The green-colored rigid ear, lug, etc. extending from the adapter must be connected to a permanent ground such as a properly grounded outlet box. Adapter shown in Sketches B and C is Not for Use in Canada.

1B. Grounded, cord-connected tools intended for use on a supply circuit having a nominal rating between 150-250 volts, inclusive: This tool is intended for use on a circuit that has an outlet that looks like the one illustrated in Sketch D. The tool has a grounding plug that looks like the plug illustrated in Sketch D. Make sure the tool is con-

(Con't on p. 4)

ELECTRICAL CONNECTIONS AND GROUNDING (Con't from p. 3)

nected to an outlet having the same configuration as the plug. No adapter is available or should be used with this tool. If the tool must be reconnected for use on a different type of electric circuit, the reconnection should be made by qualified service personnel; and after reconnection, the tool should comply with all local codes and ordinances.

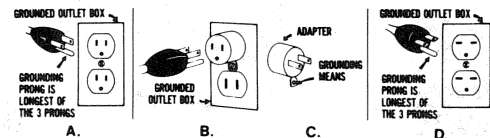

The use of a separate 15 ampere circuit is recommended for either 120 or 240 Volt operation.

RULES FOR SAFER OPERATION OF STATIONARY POWER TOOLS

- KEEP FENCE, GUARDS AND ALL INTEGRAL PARTS IN PLACE** and in working order.
- REMOVE ADJUSTING KEYS AND WRENCHES.** Form habit of checking to see that keys and adjusting wrenches are removed from tool before turning it on.
- KEEP WORK AREA CLEAN.** Cluttered areas and benches invite accidents.
- DON'T USE IN DANGEROUS ENVIRONMENT.** Don't use power tools in damp or wet locations, or expose them to rain. Keep work area well lighted.
- KEEP CHILDREN AWAY.** All visitors should be kept a safe distance from work area.
- MAKE WORKSHOP KID PROOF** with padlocks, master switches, or by removing starter keys.
- DON'T FORCE TOOL.** It will do the job better and be safer at the rate for which it was designed.
- USE RIGHT TOOL.** Don't force tool or attachment to do a job for which it was not designed.
- WEAR PROPER APPAREL.** No loose clothing, gloves, neckties, rings, bracelets, or other jewelry to get caught in moving parts. Nonslip footwear is recommended. Wear protective hair covering to contain long hair.
- ALWAYS USE SAFETY GLASSES.** Also use face or dust mask if cutting operation is dusty. Everyday eyeglasses only have impact resistant lenses, they are NOT safety glasses.
- SECURE WORK.** Use clamps or vise to hold work when practical. It's safer than using your hand and it frees both hands to operate tool.
- DON'T OVERREACH.** Keep proper footing and balance at all times.
- MAINTAIN TOOLS WITH CARE.** Keep tools sharp and clean for best and safest performance. Follow instructions for lubricating and changing accessories.
- DISCONNECT TOOLS** before servicing; when changing accessories such as blades, bits, cutters, etc.
- REDUCE THE RISK OF UNINTENTIONAL STARTING.** Make sure switch is in off position before plugging in.
- USE RECOMMENDED ACCESSORIES.** Consult the owner's manual for recommended accessories. The use of improper accessories may cause risk of injury to persons. Use of blades with knock out inserts at the arbor hole may cause injury.
- NEVER STAND ON TOOL.** Serious injury could occur if the tool is tipped or if the cutting tool is unintentionally contacted.
- CHECK DAMAGED PARTS.** Before further use of the tool, a guard or other part that is damaged should be carefully checked to determine that it will operate properly and perform its intended function—check for alignment of moving parts, binding of moving parts, breakage of parts, mounting, and any other conditions that may affect its operation. A guard or other part that is damaged should be properly repaired or replaced.
- DIRECTION OF FEED.** Feed work into a blade or cutter against the direction of rotation of the blade or cutter only.
- NEVER LEAVE TOOL RUNNING UNATTENDED. TURN POWER OFF.** Don't leave tool until it comes to a complete stop.
- ONE OPERATOR ONLY.** The same person who pulls the saw should position the work.
- Shim front saw legs to prevent carriage from creeping toward operator.
- Automatic return device is available. See saw accessories.
- WARNING:** Do not operate without using proper guards.
- Always unplug cordset or disconnect from power supply before removing blade guards for any reason.
- Before plugging cordset into outlet or reconnecting to power supply, always replace blade guards and fasten them securely.

MAINTENANCE AND OPERATION

- DO—Protect line with at least a 15 ampere **time delay** fuse.
- DO—Be sure blade rotates clockwise when facing arbor.
- DO—Be sure all clamp handles and thumb screws are tight before starting any operation. Push handles back to tighten. Pull to loosen.
- DO—Be sure blade and arbor collars are clean and recessed side of collars are against blade. Tighten arbor nut securely, using both wrenches provided. See Rule 16.
- DO—Keep saw blade sharp and properly set.
- DO—Use anti-kickback attachment on guard.
- DO—Keep arm tracks and bearing surfaces clean and dry. Periodic cleaning with dry cleaner is recommended.
- DO—Periodically recheck alignment.
- DO—Remove blade but not arbor collars and nut when using rear shaft. Tighten nut securely.
- DO—Keep motor air slots clean and free of chips.
- DO—Remove switch key and store in a safe place to prevent unauthorized operation.
- DO—Use lower guard whenever applicable.
- DO—Return carriage to full rear after each operation. A return reel is available.
- DON'T—Attempt to operate on anything but designated voltage.
- DON'T—Operate unless all clamp handles are tight.
- DON'T—Use blades of larger diameter than recommended.
- DON'T—Remove anti-kickback from guard. Adjust it to just clear the workpiece when crosscutting.
- DON'T—Rip from wrong direction—observe caution tag on guard.
- DON'T—Oil or grease arm tracks or motor.
- DON'T—Wedge anything against fan to hold motor shaft.
- DON'T—Subject table top to variable humidity conditions (keep away from dampness.)
- DON'T—Force cutting action. Stalling or partial stalling of motor can cause major damage to motor winding.
- DON'T—Remove saw blade guard when boring.
- DON'T—Remove arbor collars and nut when using rear shaft. Tighten nut securely.
- DON'T—Remove ground prong from plug. Never operate saw unless it is properly grounded.
- DON'T—Remove small scraps from table with fingers.

The lower blade guard covers the side of the teeth when the blade is behind the fence. READ THE FOLLOWING PRECAUTIONS.

CAUTIONS TO FOLLOW WHEN USING LOWER GUARD:

- The lower blade guard will provide additional protection from contact with the side of the blade—BUT NOT FROM CONTACT WITH THE FRONT OR REAR OF THE BLADE.
When the lower guard touches the fence or material being cut, it will rise up over the material—thus exposing the blade teeth. Be careful, keep your hands out of the line of cut!
- Lower blade guards may become caught in prior kerfs in the fence or table. Replace guide fence frequently.
- Short cut-off pieces of wood may become caught between the lower guard and the blade. If this happens shut off power; wait until blade stops before removal of piece.
- The lower blade guards effectiveness is limited in bevel operations. It may have to be raised out of the way when setting bevel angle to prevent bending. BE SURE THAT POWER IS OFF AND BLADE IS COMPLETELY STOPPED BEFORE MAKING ANY ADJUSTMENT.
- Catching the lower guard in saw kerfs when changing the saw set-up can be avoided by elevating the saw until the bottom of the guard clears the fence.
- When ripping narrow strips, the lower guard may have to be raised to rest on top of the fence. Be sure to use a pusher stick to feed the work.
- Do not use the lower guard with any accessory other than the correct size saw blade.
- To summarize, when in doubt about whether to use the lower guard and when practical, make a "dry run" with power off to determine if it is a help or hindrance.

MOTOR OVERLOAD PROTECTION

Your Saw Motor is equipped with a manual-reset type overload protector. If the protector "trips" and stops the motor, take the following steps:

- Press the saw "OFF" switch button and allow the motor to cool.
- After motor has cooled, the overload protector may be reset by firmly pressing the red reset button. If you do not hear an audible "click", the motor must be allowed to cool further before attempting the reset.
- After the reset is accomplished, the saw may be started by pushing the "ON" button.

MOTOR OVERLOAD PROTECTION

Your Saw Motor is equipped with a manual-reset overload protector. If the protector "trips" and stops the motor, take the following steps:

- Press the "OFF" button on the front of the arm.
- Allow the motor to cool, and then press the red RESET button. If you do not hear a "click", allow the motor to cool further until you do hear a "click" when the button is pressed.
- After the reset is accomplished, the saw may be started by pressing the "ON" button.

TROUBLE SHOOTING CHART—MOTOR

TROUBLE	PROBABLE CAUSE	REMEDY
Motor will not run.	Protector open; circuit broken.	Reset protector by pushing on red button (indicated by audible click).
	Low voltage.	Check power line for proper voltage.
Motor will not run and fuses "BLOW."	Short circuit in line cord or plug.	Inspect line cord and plug for damaged insulation and shorted wires
	Short circuit in junction box, or loose connections.	Inspect all terminals in motor junction box for loose or shorted connections.
Motor fails to develop full power. (Power output of motor decreases rapidly with decrease in voltage at motor terminals.)	Power line overloaded with lights, appliances and other motors.	Reduce line load.
	Undersize wires or circuit too long.	Increase wire sizes, or reduce length of wiring.
	General overloading of power company's facilities. (In many sections of the country, demand for electrical power exceeds the capacity of existing generating and distribution systems.)	Request a voltage check from the power company.
Motor starts slowly or fails to come up to full speed.	Low Voltage — will not trip starting relay.	Correct low voltage condition.
	Starting relay not operating.	Replace relay.
Motor overheats.	Motor overloaded.	Correct overload condition.
	Improper cooling. (Air circulation restricted through motor due to sawdust, etc.)	Clean out sawdust to provide normal air circulation through motor.
Starting relay in motor will not operate.	Burned relay contacts (due to extended hold-in periods caused by low line voltage, etc.)	Replace relay and check line voltage.
	Open relay coil.	Replace relay.
Motor stalls (resulting in blown fuses or tripped circuit breakers).	Loose or broken connections in motor terminal box.	Check and repair wiring.
	Starting relay not operating.	Replace relay.
	Voltage too low to permit motor to reach operating speed.	Correct the low line voltage condition.
Frequent opening of fuses or circuit breakers.	Fuses or circuit breakers do not have sufficient capacity.	Replace fuses or circuit breakers with proper capacity units.
	Motor overloaded.	Reduce motor load.
Frequent opening of fuses or circuit breakers.	Fuses or circuit breakers do not have sufficient capacity.	Replace fuses or circuit breakers.
	Starting relay not operating (motor does not reach normal speed.)	Replace relay.

For Wiring Diagram see Parts Bulletin.

RADIAL SAWS Shape & Joint

Make finished edges for glue jointing long boards. Edge & surface shape with many different knife sets for decorative mouldings and cabinet making, panel raising and other special woodworking effects.

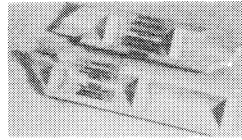

30025 Shaper / Joiner Fence. Converts saw for precise shaping and jointing operations. In feed fence has 1/32" & 1/16" adjustments.

Deluxe Shaper & Knives Yield Finest Quality Work.

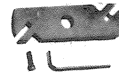

R6480 2-Knife Shaper Head. 127 mm (5") long. 38.1 mm (1 1/2") wide, 15.88 mm (5/8") arbor hole.



Sets of 2 Knives—Self Aligning. 6.4 mm-9.6 mm (1/4"-3/8") thick, 25.4 mm-38.1 mm (1"-1 1/2") long. High speed steel with one hole and held by 6.4 mm (1/4") socket screw.



R3076 8 mm (5/16") Bead and Cove Knives



R6477 50.8 mm (2") Jointing/Surfacing and Panel Raising Knives



R6478 Cabinet Door Lip Knives, 9.6 mm (3/8") radius, 7° rake

Economical Starter Set and Knives



R6501 3-Knife Shaper Head Set. 1 R6500 Head; 1 R6505 Glue Joint Knives; 1 R6512 Universal Bead Knives; 1 R6515 Cabinet Door Lip Knives; 1 R6517 8 mm (5/16") Bead and Cove Knives.

Sets of 3 Knives:



R6506 Ogee Casing Knives



R6518 25.4 mm (1") Straight Knives



R6519 Tongue Knives



R6520 Groove Knives



34003 Tool Guard. Replaces standard blade guard for shaping, jointing, disc sanding and planing operations. Will accommodate tools up to 203.2 mm (8") dia.

RADIAL SAWS Saber Saw

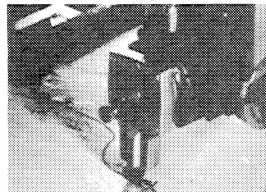

30020 Saber Saw. Does curve work the fast easy way in wood, plastic, metal. Complete with blade.

R8028 Saber Saw Blades. Consists of one each: Fine, Medium, Coarse.

RADIAL SAWS Rout

35500 Router Attachment. Holds router motor for overarm routing applications. Ideal for variety work. Uses most Router motors.



RADIAL SAWS Drill

R1208 9.6 mm (3/8") Drill chuck w/key fits right hand arbor on models 7739 & 7749 for horizontal drill. A must for dowel jointing.



RADIAL SAWS Plane & Sand

Rotary planers surface and size boards. Sanders finish surfaces with either straight or curved edges.

R6380 Rotary Planer (includes knives and wrench). Surface planes. Excellent for thickness sizing, panel raising.

R6383 Knife Set. 2 Knives for R6380

Disc Sander. 15.9 mm (5/8") L.H. thread. **R7470 203.2 mm (8") dia.** Sander Disc Set (includes bevel edge disc, one 203.2 mm (8") dia. pressure-sensitive sandpaper disc No. 60 grit). Fast material removal. Surface, end grain and bevel sanding.

30016 6 assorted 203.3 mm (8") pressure-sensitive sandpaper discs (1 No. 50, 2 No. 60, 3 No. 80 grits).

Drum Sanders.

30092 3" (76.2 mm) dia., 76.2 mm (3") long Drum Sander, 15.9 mm (5/8") L.H. thread. Fits arbor shaft of all 254 mm (10") and 305 mm (12") models for straight and curved edges up to 50.8 mm (2") thick.

30091 2" dia. (50.8 mm) Drum Sander, 76.2 mm (3") long, 15.9 mm (5/8") L.H. thread. Fits arbor shaft of all 254 mm (10") and 305 mm (12") models for medium radius curves and delicate sanding.

30090 1" dia. (25.4 mm) Drum Sander, 76.2 mm (3") long, 15.9 mm (5/8") L.H. thread. Fits arbor shaft of all 254 mm (10") and 305 mm (12") models for small radius curves and delicate sanding.

RADIAL SAWS Dado

These great DADO SETS cut uniform slots, grooves, half laps, drawer corners, rabbet cuts, with Spacers and Chippers Assure Finest Quality Cut and Precision over Longest Life.

R6024 152.4 mm (6") Dado Head Set. Flat Ground (2 Blades, 4 Chippers 3.2 mm (1/8"), 1 Chipper 1.6 mm (1/16") 15.9 mm (5/8") bore.

R6025 203.2 mm (8") Dado Head Set. Flat Ground (2 Blades, 4 Chippers 3.2 mm (1/8"), 1 Chipper 1.6 mm (1/16") 15.9 mm (5/8") bore.



RADIAL-ARM MACHINE CONTROLS. The versatility of the radial-arm machine is due, in part, to its controls, and these are the keys to its successful operation. Learn to use them by adjusting the machine for all operations before actually starting to operate it. All controls, as well as the major parts of the radial-arm machine, are shown and identified here.

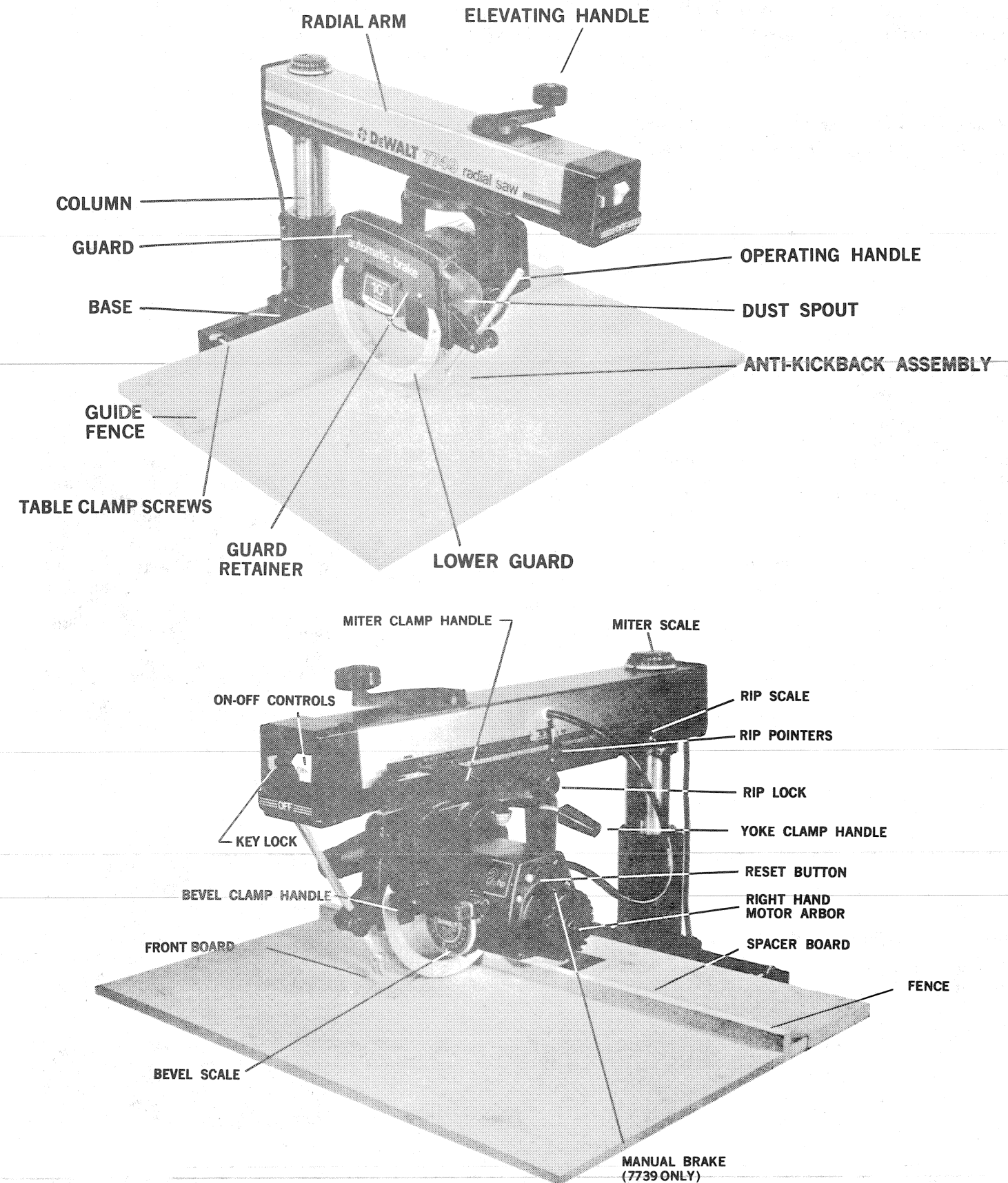

ALIGNMENT MAKE CERTAIN SAW IS NOT CONNECTED TO POWER SOURCE. NOW BEFORE GOING ANY FARTHER TAKE TIME OUT TO READ THE FOLLOWING IMPORTANT INSTRUCTIONS. THE ALIGNMENT OF YOUR NEW SAW IS MOST IMPORTANT NOT ONLY FOR MAKING ACCURATE CUTS, BUT ALSO FOR SAFER OPERATION. THE TIME SPENT HERE WILL ADD CONSIDERABLY TO YOUR OVERALL ENJOYMENT OF THIS FINE PRODUCT. NOTE: SECURE TABLE FRAME OF UNIT TO A STURDY WORK BENCH, APPROPRIATE TABLE, OR LEG STAND, WITH SCREWS OR BOLTS BEFORE MAKING ALIGNMENTS OR OPERATING. THESE UNITS WILL FIT A NO. R-1201 LEG STAND.

Your saw was completely inspected and tested but only partially aligned at the factory. The alignments preceded by an asterisk (*) are to be made by you prior to use.

YOKE CLAMP HANDLE ADJUSTMENT

The purpose of this handle is to provide a friction lock between the upper face of the yoke and the bottom face of the rollerhead. It should also eliminate any play between these two parts. In operating position the yoke clamp handle is pushed back from the hand grip of the yoke. If, at any time, it is possible to move this handle so that it strikes the rear leg of the yoke, it is not in proper adjustment. Its proper position for machine operation is approximately 90° or less to the hand grip of the yoke.

To readjust:

- (a) Pull yoke clamp handle forward to release friction locking action.
- (b) Insert screw driver between the yoke and the notched clamp adjuster. Flex the adjuster downward just enough to pass over the lug stop on the yoke.
- (c) Rotate clamp adjuster as necessary (to loosen, clockwise; to tighten, counter-clockwise). Be sure the notch in the adjuster is positioned properly over the yoke lug stop at final setting.
- (d) This saw has a king bolt with a hex hole in the threaded end which is easily accessible without removing any part from saw. Adjustment can be made with the 1/4 hex wrench which is furnished with the saw.

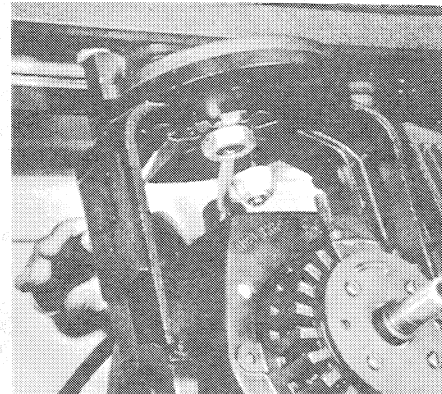

ADJUSTING BEVEL CLAMP HANDLE

The purpose of the bevel clamp is to hold the motor at any angle. This is accomplished by the cam action of the clamp pulling the clamp pad against the dial plate.

To adjust:



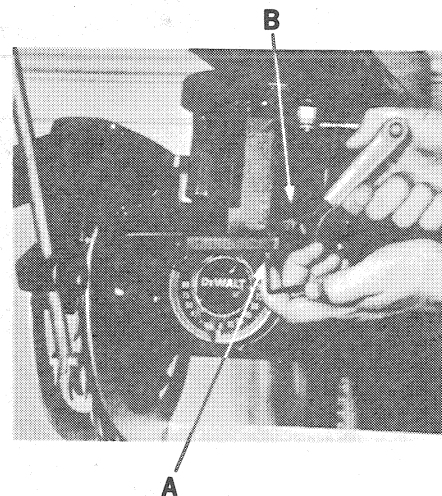

Loosen set screw (A), tighten clamp bolt (B), then retighten set screw.



ATTACHMENTS & ACCESSORIES

Even more RADIAL SAW versatility with these attachments . . .

RADIAL SAW: SAW BLADES All blades listed have 15.9 mm (5/8") arbor hole.

	Cat. Number	Size	Type	No. of Teeth	Quality
	R1041	254.0 mm (10")	Combinaton, Chisel Tooth	30	Premium
	R2919	203.2 mm (8")	Plywood Veneer, Taper Ground	176	Standard
	R1014	254.0 mm (10")	Plywood Veneer, Taper Ground	200	Premium
	R1013	254.0 mm (10")	Planer, Hollow Ground	75	Premium
	R1426	254.0 mm (10")	Rip	36	Standard

RADIAL SAW Legs



R1201 Leg Stand. For models 7739, 7749, 7779.

35021 Deluxe Machine Stand. Use with DeWalt 7715, 7716 & 7717, B&D Bench Grinders and Miter Box. A stable work shop bench for many uses. Work surface 584.2 mm x 476.3 mm (23" x 18 3/4") high. Rubber foot grommets.



Automatic Return Device. Fastens to rear of machine arm. Returns saw carriage to rear position. **35026** fits 10" and 12" Radial Saws.

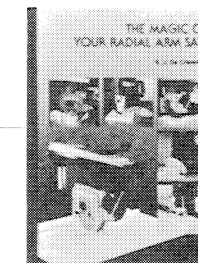

35601-15 "The Magic of Your Radial Arm Saw." 310 pages of highly descriptive ideas and illustrations.

R1516 Splitter and Anti-Kickback Device. For all 254 mm (10") radial arm saws.



35010 Roller Head Stop. Mounts on arm of 254 mm (10") and 305 mm (12") machines to limit travel of roller head to any desired cut-off length.

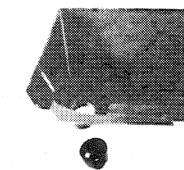

32000 Saw Dust Catcher. Sturdy high-impact plastic unit collects dust in crosscut, miter and bevel positions. Fits 7739, 7749 machines and fits other models if modified.

PROBLEM	POSSIBLE CAUSE	SOLUTION
5. Saw blade or Dado blades tend to push lumber to one side when cross cutting.	Saw blade is heeling.	Make heel adjustment.
	Column too loose in base.	Make proper adjustments
	Too much play between arm and column.	
	Roller head too loose in arm.	
	Yoke too loose when clamped to roller head.	
	Fence not straight.	Replace.
Dull blade or cutters.	Replace or sharpen.	
6. Cut depth varies from one end of stock to the other.	Table top not parallel with arm.	Adjust table top parallel with arm.
	Column too loose in base.	Make proper adjustments.
	Too much play between arm and column.	
7. 45° bevel cut not accurate.	Saw blade not perpendicular to table top.	Make saw blade adjustment.
	Column too loose in base.	Make proper adjustments.
	Too much play between arm and column.	
	Roller head too loose in arm.	
	Yoke too loose when clamped to roller head.	
	Bevel clamp handle loose.	
Table top not parallel with arm.		
8. Saw tends to advance over lumber too fast.	Roller head bearings not properly adjusted.	Adjust roller head bearing to arm.
	Dull blade.	Replace or sharpen.
	Not feeding saw properly.	Draw saw blade across lumber with a slow and steady pull.
9. Saw does not traverse smoothly in tracks.	Dirty tracks.	Clean.
	Bad bearing.	Replace bearing.
10. Miter scale not accurate at various miter angles.	Scale pointer not properly adjusted.	Adjust scale pointer.
11. Elevating handle slips when elevating or lowering saw.	Belt tension not sufficient.	Adjust belt tension.
	Set screw in elevating arm loose.	Tighten set screw.
	Base not adjusted properly.	Adjust base to column.
12. Clamping force not sufficient at miter angles other than 45°.	Arm clamp out of adjustment.	Adjust arm clamp.
13. Clamping force not sufficient at bevel angles other than 45°.	Bevel clamp handle too loose.	Adjust bevel clamp handle.

ADJUSTING ROLLERHEAD BEARINGS TO ARM TRACKS

The rollerhead is suspended by four special tolerance, greased-packed, double shield ball bearings. These bearings are mounted on two straight bearing shafts and two eccentric bearing shafts. In proper adjustment the top and bottom radii of all four bearings should be in contact with the arm tracks for their entire length and head should roll freely but with some resistance. Excessive bearing pressure will cause difficult operation and rapid wear. Too little pressure will cause loss of accuracy and the saw will try to feed itself into the material being crosscut. Proper adjustment will require a force of 4 to 6 pounds to move the rollerhead along the arm at a constant speed. The front and rear bearings should be adjusted to contribute equally to this force. NOTE: the end cap was removed for clarity and it need not be removed for this adjustment.

- Wipe tracks with a clean dry lint-free cloth.
- Bring motor, yoke, and rollerhead assemblies to the end of arm.
- Set in "out rip" position.
- Loosen hex nuts on left side, front and rear.
- Insert 1/8" Allen wrench in recess at bottom of shafts and turn bearing shaft until the bearing is snugly against the track. Repeat for the second bearing. Check the force required to move the rollerhead. Readjust as required.
- Tighten the hex lock nuts while holding each bearing shaft in its adjusted position.

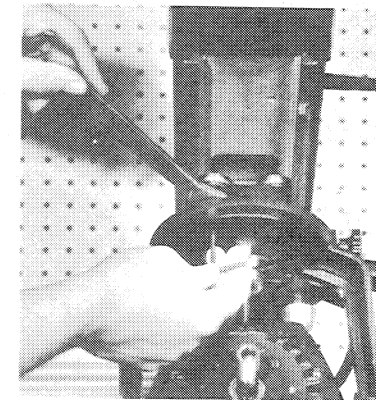

ARM TO COLUMN

Prior to readjusting the arm clamp cam check adjustment of the arm to column. With the arm clamp released there should be no vertical play in the arm, and the arm should fit snugly on the column.

To adjust:

- Loosen two jam nuts (A) in slot at rear of arm, turning them clockwise.
- Adjust bolts (B) for proper fit and retighten jam nuts (A).

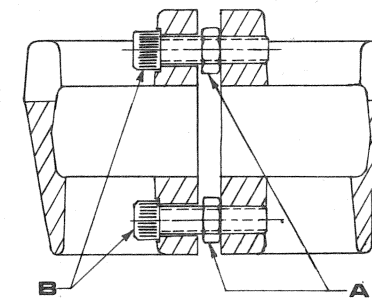

Cross section of back of arm with shroud removed

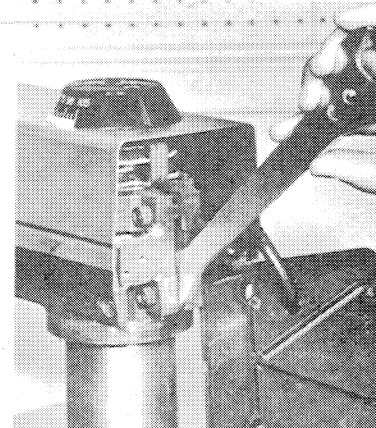

REMOVING SHROUD

To make adjustments in the arm it is necessary to remove the arm cover, as follows:

- Remove elevating handle. Handle is held on by a set screw.
- Remove front end cap & miter clamp handle knob.
- Remove arm cover by rotating it over the handle post and then slide it off of the miter clamp handle lever.

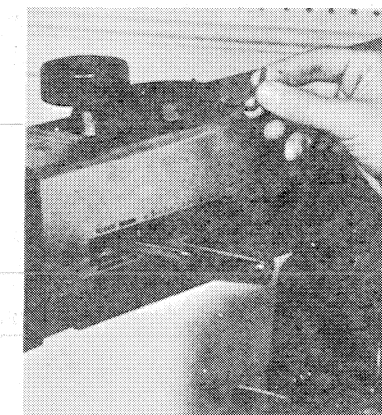

ADJUSTING ARM CLAMP

The arm clamp handle operates a cam that clamps and releases the arm, and lifts the miter latch from the 0° and 45° slots.

To adjust:

- Loosen set screw (A) on clamp bolt (B) in clamp cam pivot pin (C).
- To tighten clamp turn clamp bolt clockwise. (Very little adjustment should be made prior to trying the clamp.)
- Retighten set screw (A).

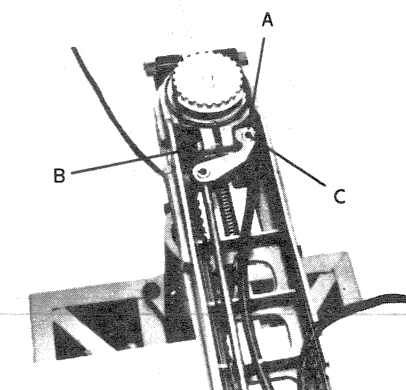

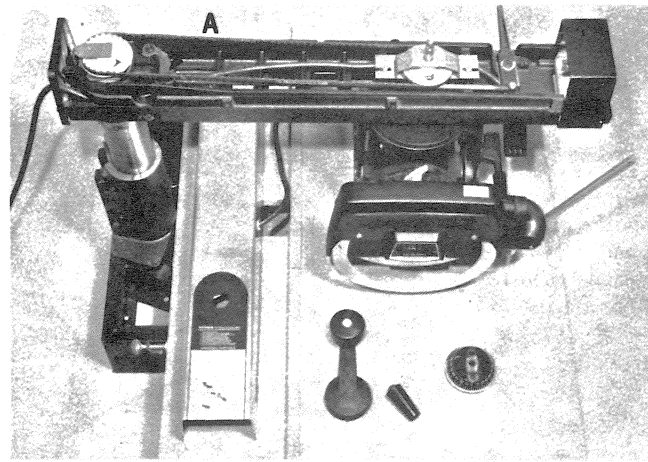

MITER CLAMP HANDLE POSITION

Position of the clamp handle may need adjusting after the clamp cam has been adjusted.

To adjust:

- (a) Loosen set screw (A) in pivot pin on the clamp rod.
- (b) Turn the clamp rod so that the handle does not contact casting when clamped or released. Retighten set screw (A).

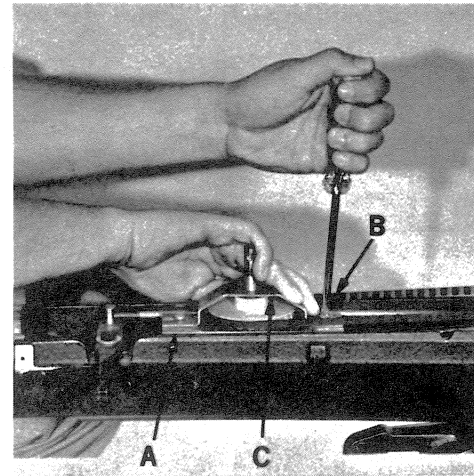

ADJUSTING BELT TENSION

It is necessary to remove the arm cover to adjust the timing belt tension.

To adjust:

- (a) Loosen two screws marked (A) and (B).
- (b) Pull and hold sprocket bracket (C) to apply belt tension.
- (c) Tighten screws (A) and (B) securely.

Note that excessively tight base adjustment may cause the belt to slip or jump from its pulley.

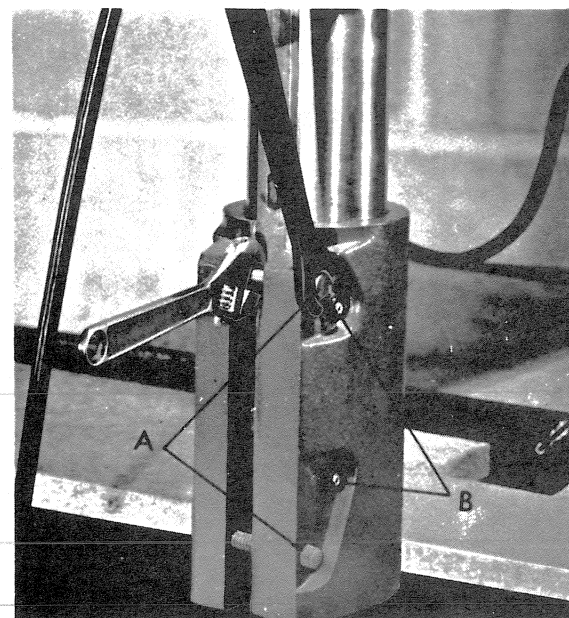

ADJUSTING BASE TO COLUMN

If noticeable play exists between the base and the column or if the saw is hard to elevate, then the base requires adjustment.

To adjust: (Face rear of machine)

- (a) Loosen locknuts and brass set screws (B). Loosen jam nuts and clamp bolts (A). Adjust lower bolt first.
- (b) Elevate and lower the arm. If the column binds and elevation is difficult, tighten the jam nuts (A) against the right side of the slot until there is no play but elevation is moderately easy. Then tighten bolts (A) holding the jam nuts in place.
- (c) If the column is loose in the base, tighten bolts (A) until the proper adjustment is achieved. Holding each bolt tighten its jam nut against the left side of the slot.
- (d) Push the arm to the right. Bring the setscrews (B) lightly against the column key to remove all rotary play. Tighten their locknuts lightly. Caution: excessive torque on the setscrews or locknuts may cause setscrew damage.

ALIGNMENT GUIDE FOR ACCURATE CUTTING

It is important to realize that an improperly adjusted saw just will not yield the accurate cuts desired. If the machine seems to cut inaccurately, its adjustments and alignments should be checked.

The following guide is listed for your convenience. However, *changing one adjustment will affect another, so it is best to perform all of the alignment procedures when correcting any one problem.*

ALIGNMENT GUIDE FOR ACCURATE CUTTING

PROBLEM	POSSIBLE CAUSE	SOLUTION	
1. Saw will not make a square cross cut or a good 45° miter cut.	Arm is not perpendicular to guide fence.	Adjust cross cut travel with guide fence.	
	Arm has excessive play at end.	Tighten adjusting screws.	
	Column is loose in base.	Make proper adjustment.	
	Too much play between arm and column.	Make proper adjustment.	
	Roller head too loose in arm.	Adjust roller head correctly.	
	Yoke too loose when clamped to roller head.	Adjust yoke clamp handle.	
	Saw dust between lumber and guide fence.	Keep table top clean.	
	Table not parallel with arm.	Make proper adjustment.	
	Guide fence not straight.	Replace fence.	
	Rear edge of fixed board not straight.	Sand or replace.	
	2. Lumber has a tendency to walk away from fence when ripping or ploughing.	Saw blade is not parallel with fence.	Make heel adjustment.
		Arm not perpendicular to guide fence.	Adjust cross cut travel with guide fence.
Dull blade or cutters.		Sharpen or replace blade.	
3. Saw stalls when ripping or ploughing.		Fence not straight.	Replace Fence.
		Feed rate too fast.	Slow feed rate.
		Wrong blade.	Use correct blade.
	Column too loose in base.	Make proper adjustments.	
	Too much play between arm and column.		
	Roller head too loose in arm.		
	Yoke loose when clamped to roller head.		
	Saw dust between lumber and fence.	Keep table top clean.	
	4. Saw blade scores lumber, not giving a good finished cut.	Saw blade is heeling.	Make heel adjustment.
Column too loose in base.		Make proper adjustments.	
Too much play between arm and column.			
Roller head loose in arm.			
Yoke too loose when clamped to roller head.			
Bent blade or dull.		Replace blade.	
Not feeding saw properly.		Draw saw blade across lumber with a slow and steady pull.	
Using improper blade for finish cut desired.		Change blade.	

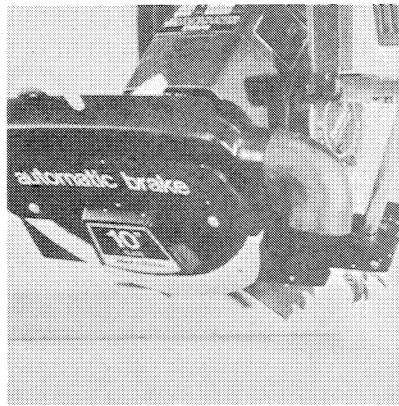

COMPOUND MITER

Read Figs. A, B, and D. Start in bevel cut-off position. Pull arm clamp handle. Swing the arm into desired miter position, usually 45° or in between angles, then relock arm clamp handles. Pull saw across for miter cuts. The compound miter cut is simply a combination bevel and miter cut.

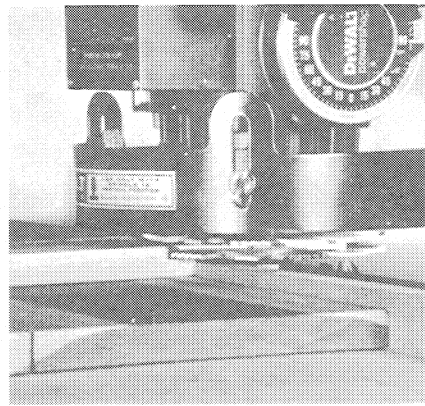

RABBET

Re-read Figs. B, C, and D. First, elevate arm until motor locates in 90° vertical position. Place shaper guard over dado head. Swivel motor into rip position so that guard sets above material. Use column crank, also rip lock to set dado for cut desired. Feed material evenly, firmly against guide. Tilt motor for bevel rabbet cuts.

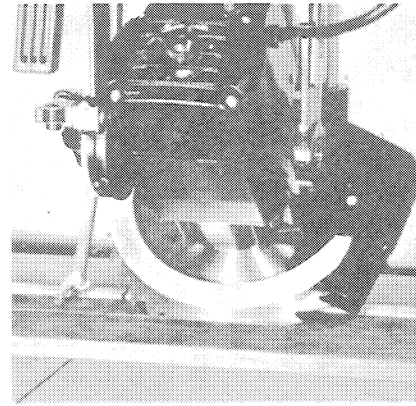

BEVEL RIP

Read Figs. B, C, and D. Start in bevel cross-cut position as described above. Now, place the saw into rip position and (using rip lock) lock securely against arm at desired point. Be sure to lower guard at in-feed position, adjust the anti-kickback device and then use a wood "pusher" board to further prevent kickback.

IMPORTANT: Check Lower Guard Precautions on Page 4.

NOTE
ALWAYS WEAR GOGGLES.
WEAR DUST MASK IF OPERATION IS DUSTY.

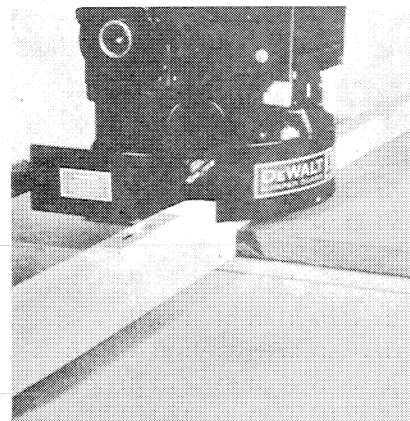

SHAPE

Place shaper cutter on motor arbor; cover with shaper guard. Now, set up the machine in the same position as RABBET. Set shaper cutter for the profile desired. Lock saw carriage securely, adjust shaper guard so that it just clears the material. Feed the material firmly and evenly into the shaper cutters. Maintain positive pressure.



DADO

Replace saw blade with dado head. Use for across or angle dado cuts same as saw blade. When determining depth of cut; simply lower dado until it just touches top of material. Then lower dado head as desired. Each full turn equals 1/8 inch, one-half turn 1/16 inch, etc. Wide dado cuts can be made by making successive passes across the material.

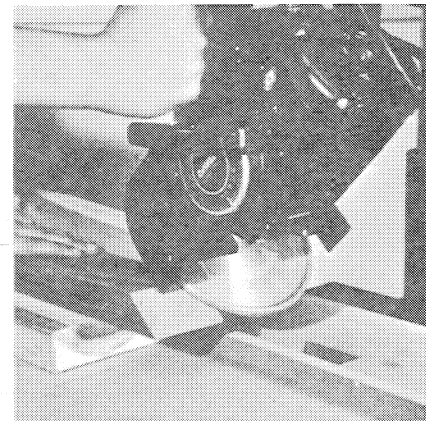

DISC SANDER

Remove arbor nut. Leave both collars in place and thread disc onto arbor. Locate disc sander wherever desired on machine. For bevel and surface sanding only, place shaper guard over the disc sander. For finish work on angles, use work support fixture. For surface sanding tilt the disc sander into vertical position. Feed the material evenly for best results. Use finer paper for final finish.

*ADJUSTING TABLE TOP PARALLEL WITH ARM

The table top surface must be parallel with the horizontal plane of the arm tracks.

To align proceed as follows:

- (a) Remove the guard, the blade and the washers from the motor.
- (b) Elevate the saw about 20 turns.
- (c) Release the bevel lock lever and pull the bevel locating pin.
- (d) Revolve the motor until the arbor is 90° to the table.
- (e) Release the miter lock and locator so you can move the arm to the right and left.
- (f) Lower the arm until the end of the arbor is just over the table.
- (g) Bend down so that your eye is even with the table top.
- (h) Move the arm to the right and left and push the roller head back and forth and notice if there is any change in the distance between the end of the arbor and top of the table.
- (i) If the clearance (distance) is the same over the entire surface the table is parallel to the arm.
- (j) If there is a difference in the clearance, adjust as follows.

Position the end of the arbor directly over the highest point on the table. Look under the table and you will notice four (4) locking nuts that hold the cleats to the frame. Now position the end of the arbor directly over the nearest locking nut to this high point. Lower the arbor until it touches the table. You may have to adjust one, two or three nuts to get the table parallel. Now move the arbor directly over another locking nut. Loosen the locking nut and push the table up until it touches the end of the arbor. Tighten the locking nut. If required, adjust the other locking nuts in the same manner.

A concave table top condition can be eliminated by proper adjustment of the jackscrew and locking nut assembly. Assemble 5/16-18x1 1/4 adjusting screw "A" and 5/16-18 nuts "B" and "C" from hardware bag as shown in Figure A.

Hold jackscrew "A" while turning pressure nut "B" clockwise (viewed from the top). After jackscrew contacts table and continues upward, center of table top will be lifted towards motor arbor. When the table top is parallel to the motor, lock the jackscrew by turning the locking nut "C" clockwise (viewed from the bottom) while holding jackscrew "A". Check table top for parallelism once more, then tighten the pressure & lock nuts "B" and "C" once more to assure locking jackscrew "A".

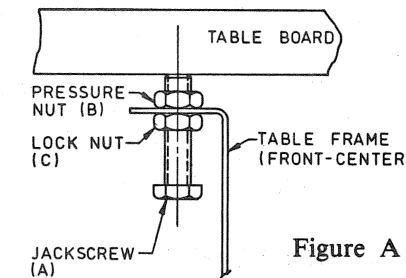
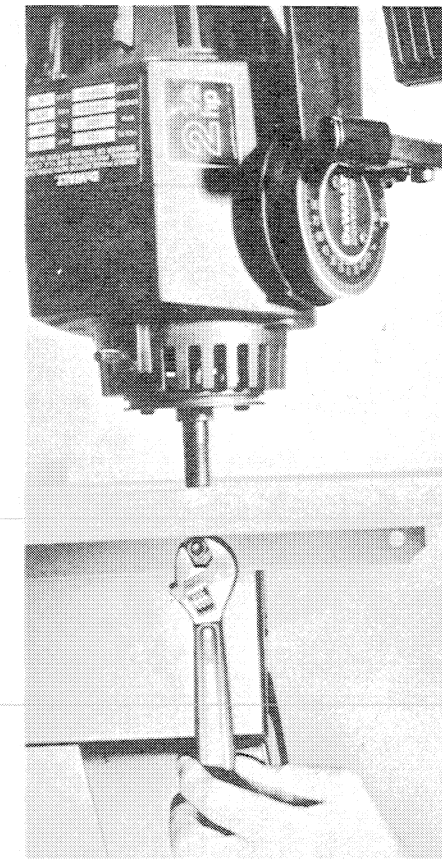
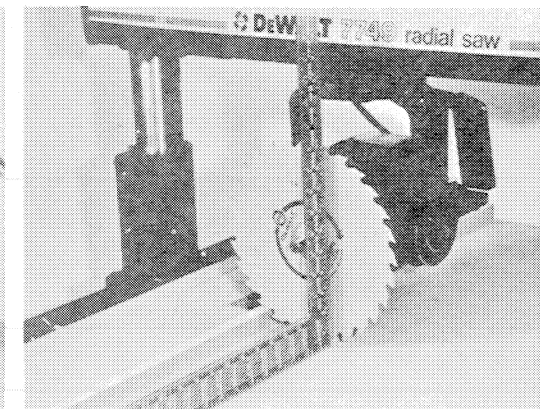
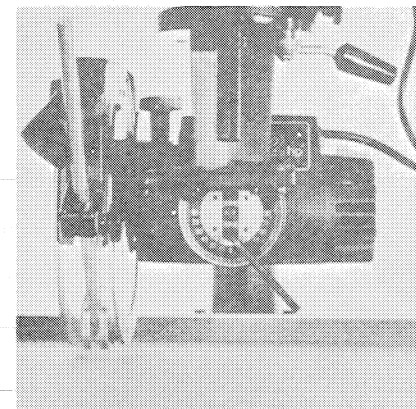

Figure A

CHECK TABLE TOP AND GUIDE FENCE



The table top assembly and guide strip are checked for straightness before leaving the factory. As all wood products must "breathe" and are affected by various humidity conditions, a slight change from factory conditions may sometimes be found. Straightness of top and Guide Strip, with Clamp Screws tight, should be checked with a square or straight edge. Correction can be made only by sanding. A slight variation from perfect straightness of table top will not normally affect the average woodworking requirements.

Do not use a level except as a straight edge. (This check is for straightness, not levelness with the floor.)

* ADJUSTING BLADE PERPENDICULAR TO WORK TOP

With the arm in cross-cut position, all latches engaged and all clamp handles locked place a steel square with one edge on the table top parallel to guide strip and the other edge against the flat of the saw blade (place in saw blade gullets and not against teeth because of tooth set). If blade is not flat against square, adjust as follows:

- (a) Remove bevel pointer by removing two screws.
- (b) Loosen two outside socket head screws.
- (c) Tilt motor until blade is flat against the square and again lock (very firmly) socket head screws. Replace bevel pointer.

NOTE: In some cases it will be found necessary to also loosen center cap screw in order to adjust motor.

*** BEVEL SCALE**

The bevel scale is located at the front of the motor. When the motor is positioned for vertical cutting the pointer should be at 0 on the scale. To adjust loosen the two screws, move the pointer to 0 and tighten.

*** ADJUSTING CROSS CUT TRAVEL WITH GUIDE FENCE**

With the miter latch engaged and arm clamp handle locked, place a wide board (1" x 12" if available) against the guide strip. Cross-cut this board with a set tooth blade. Check cut with a steel square. If cut is not square, the arm is out of alignment with the guide fence.

To readjust:

- (a) Loosen miter clamp handle.
- (b) Loosen two set screws (A) under the miter adjusting screws (B).
- (c) Lay steel square on table top with one edge against guide fence and the other edge at 0° cross-cut as shown in picture.
- (d) Move saw carriage and blade forward along steel square to determine which way arm must be adjusted.
- (e) If saw blade moves toward square as it comes forward, disengage miter latch. With allen wrench loosen left adjusting screw and tighten right adjusting screw, re-engage miter latch. Check and repeat if necessary.
- (f) If saw blade moves away from square as it comes forward, disengage miter latch. Loosen right adjusting screw and tighten left adjusting screw, re-engage miter latch. Check and repeat if necessary.
- (g) When saw travel is parallel to square for entire length, lock adjustment screws in place by retightening set screws.

NOTE: Do not tighten adjusting screws enough to retard the operation of the miter latch.

*** MITER POINTER**

The miter pointer is located at the top on the back of the arm. When the arm is positioned for straight cross-cut the pointer should be at 0° on the scale.

To adjust:

Loosen rear screw located on the top of the miter scale (H), rotate the scale to zero, retighten screw.

DIRECTIONS FOR REMOVING ARBOR NUT

1. Fit 5/16" wrench into front end of motor shaft. (This is a holding wrench only.)
2. Fit large wrench on arbor nut as nearly parallel to first wrench as possible.
3. While holding Allen wrench stationary with left hand, use downward pressure of right hand on second wrench and nut will loosen. See Figure 11, page 3.

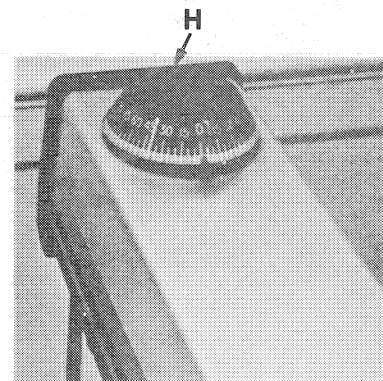
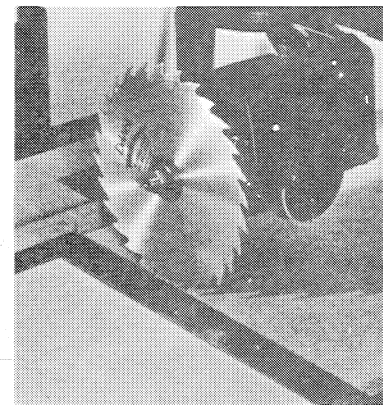
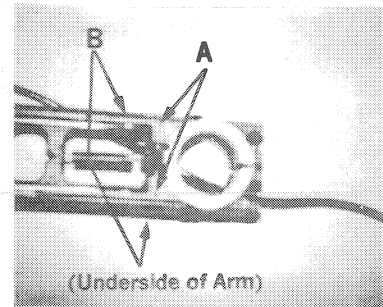
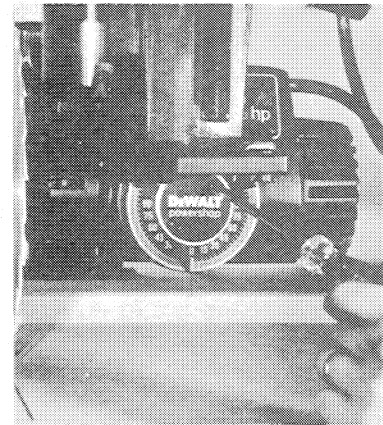

TYPICAL CUTS WITH A RADIAL ARM SAW

(SEE PAGE 14 FOR FIGURES A, B, C, D)

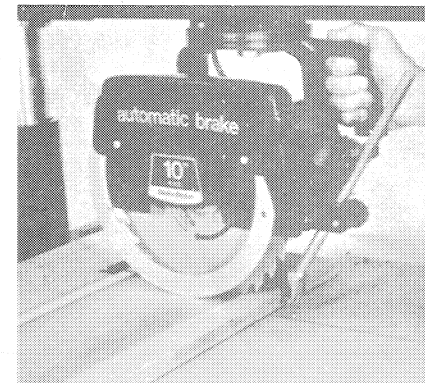

CROSS CUT

Read Fig. A. Set Arm at right angle to the guide fence, at 0° on the miter scale. With the miter latch in column slot at 0° position, securely lock arm with arm clamp handle. Place material on work table, against guide fence, draw saw blade across for the cut just far enough to sever wood. Do not bring saw blade completely through the wood. After completing cut, return saw blade behind guide fence.

The model 35010 "Roller Head Stop" accessory is available for use as an adjustable cross cut stop to prevent motion of the blade beyond the position necessary to complete the cut when performing repetitive cutting operations.

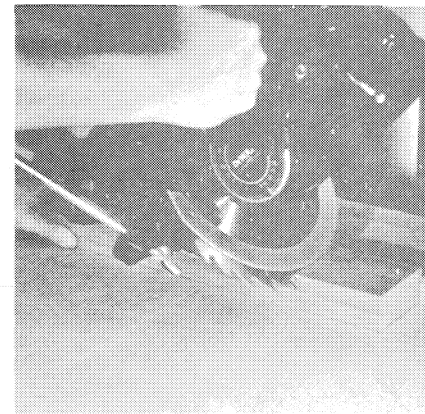

BEVEL CUT OFF

Read Figs. B and D. Start in cross cut position. Elevate the saw by rotating crank. Release bevel clamp handle and tilt motor in yoke to angle desired on bevel scale. Locating pin quickly locates 0°, 45°, and 90° positions. If any other angle is desired, bevel clamp will hold motor in position. CAUTION. Prevent the blade from contacting the base at angles of greater than 45°, tilt the guard slightly so that the rear of the guard hits the base.

NOTE
ALWAYS WEAR GOGGLES.
WEAR DUST MASK IF OPERATION IS DUSTY.

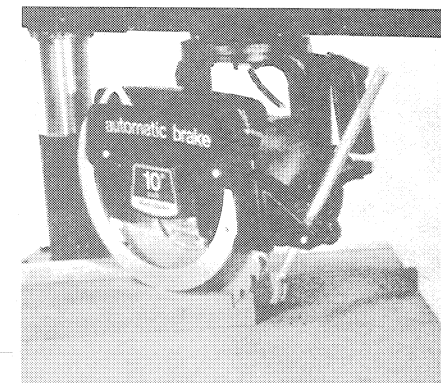

MITER

Pull arm clamp handle and swing into desired angle shown on miter scale. The miter latch locates the popular left hand and right hand angles automatically. Push clamp handle to lock the arm. Cutting action same as cross cut.

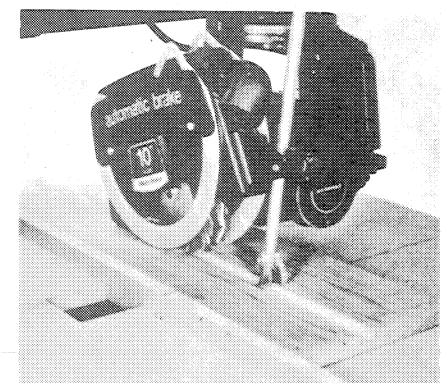

PLOUGH

This operation is done with dado head in RIP position. Lower dado head for depth of cut desired, then lock carriage securely against machine arm. Be sure to adjust guard on infeed side, lower anti-kickback assembly to hold material. When starting cut, hold material firmly down on table and back against guide. Feed evenly. Never feed material from side on which anti-kickback device is located.

IMPORTANT: Check Lower Guard Precautions on Page 4.

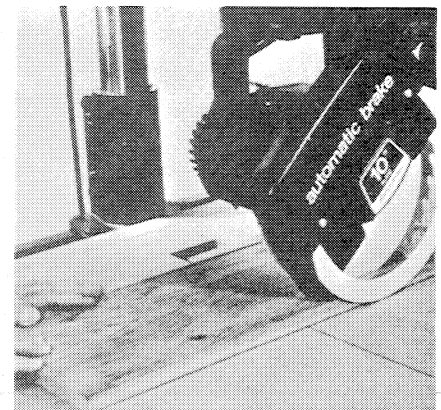
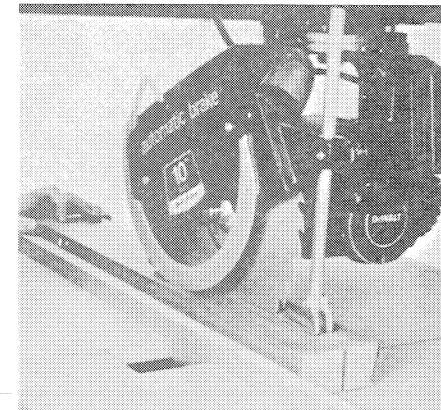

IN-RIP AND OUT-RIP

Read Fig. C. Start with arm locked in cross cut position. Pull out motor to end of arm. Pull yoke clamp handle against pin lifter. Revolve motor 90°, right or left, for out-rip or in-rip position, and lock yoke clamp handle. Locate saw for desired width of rip, using rip scale, and lock saw carriage by tightening rip lock against side of arm. Adjust guard so that infeed end almost touches material. Lower anti-kickback assembly so that fingers are approximately 1/8 inch lower than material. Slide the piece of material to be cut under anti-kickback fingers. Try pulling material in opposite direction. The anti-kickback fingers should grab it, if they do not readjust anti-kickback assembly. With material against guide strip, feed evenly into saw blade; give it a chance to cut. DO NOT FORCE. DO NOT FEED FROM ANTI-KICKBACK SIDE OF GUARD. FOLLOW INSTRUCTIONS ON CAUTION TAG.

ANTI-KICKBACK WITH SPREADER.
See accessory page 19 for catalog number.

ANTI-KICKBACK SPREADER OPERATING INSTRUCTIONS FOR RIPPING

1. Disconnect the electrical power.
2. Rotate the adjusting screw to center the splitter blade in the kerf made by the blade.
3. Adjust the upper guard to drag lightly on the top surface of the workpiece. Lock it securely in this position.
4. Lower the splitter and anti-kickback until the anti-kickback fingers are about 1/8" below the top surface of the workpiece. Lock it securely in this position.
5. Slide the workpiece under the anti-kickback fingers in the normal rip direction. Try to pull the workpiece backwards. If the fingers do not prevent backwards movement repeat step 3.

OPERATING INSTRUCTIONS

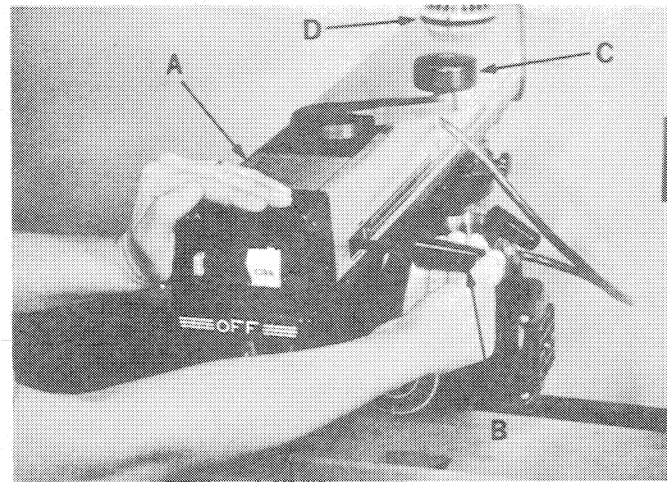

FIG. A

ARM ROTATES RIGHT OR LEFT FOR MITER CUTS

Pull clamp (B) then swing the arm (A) right or left to the desired angle. The calibrated miter scale (D) is at eye level and shows the precise angle you want. With the handle released, the miter latch will automatically locate 0° and 45° angle. After positioning arm (A) in the desired angle, push clamp (B) to lock the arm.

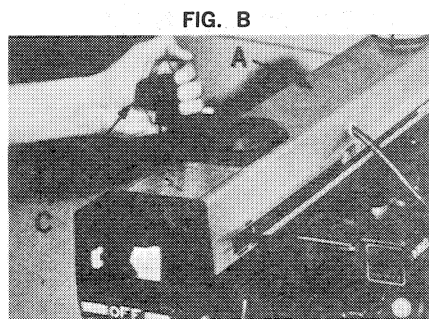

FIG. B

Elevation

Each full turn on the elevating handle (C) lifts or lowers the arm (A) exactly 1/8 inch.

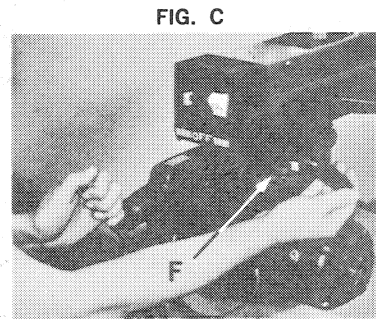

FIG. C

Yoke Swivels 360° for Rip Cuts

Pull yoke clamp handle (E) against pin lifter (F) and swing yoke right or left. With lifter released, the yoke automatically stops at four 90° positions.

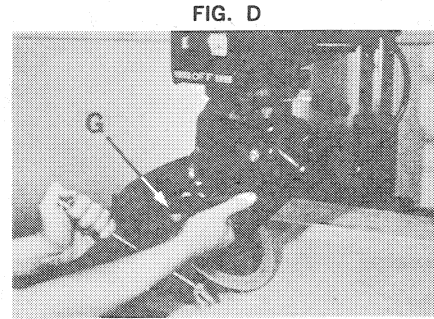

FIG. D

Saw Tilts for Bevel Cuts

Elevate the arm 2 1/2 inches (18 turns). Pull handle (G) and tilt to the desired angle. With the handle released, the bevel locating pin automatically locates popular 0°, 45°, and 90° bevel positions. When desired bevel angle is obtained, push clamp handle (G) and lock bevel.

CROSS-CUTTING

If the splitter and anti-kickback accessory is used, adjust the splitter and anti-kickback so that the splitter blade just clears the fence and workpiece. Clamp it in this position. This provides blade guarding from the front direction.

NOTE: Always leave the anti-kickback assembly in place. Adjust it to just clear the workpiece in crosscutting operations and about 1/8" below the top of the workpiece during all ripping operations. Observe caution tag on guard - do not rip from anti-kickback end.

FENCE LOCATIONS

Position (A) is used for most cutoff and narrow ripping operations. Position (B) is used for maximum width ripping. Position (C) is used to achieve extra cutoff capacity in thin work. To achieve this position on Model 7749 rip a 1 5/8" wide strip off the spacer board and place this piece between guide fence and front board. Do not use saw with missing fence, loose fence, or partial fence.

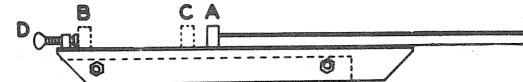

ADJUSTING CROSS-CUT TRAVEL PARALLEL TO ARM TRACKS (HEEL ADJUSTMENT)

Both the leading and trailing teeth of the saw blade should travel in the same plane parallel to the arm tracks. To check, place a board 4" x 1" or larger against the right side of the guide fence. With the machine in 0° cross-cut position and all locks and latches engaged, end trim this stock by allowing only the front teeth of the blade to clear the stock and the rear teeth remaining in the cut. Now remove the stock by sliding to the right before returning the cutting head to the back of the arm. Examine the cut edge of the stock. If blade marks of the rear teeth are prominent on the cut stock the rear teeth are not exactly following the front teeth and adjustment is necessary. (The arcs of the rear teeth start at the bottom front of the stock and travel up and back.) Repeat this same operation with the stock against the left side of the guide fence.

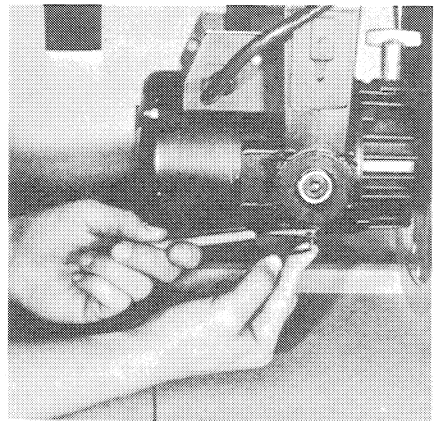

To adjust when marks are on stock cut on right side:

- Disengage bevel clamp handle. Do not pull bevel pin.
- Loosen right and left lock nuts at rear of yoke.
- Loosen right set screw about 1/6 turn and tighten left set screw.
- Retighten lock nuts and bevel clamp handle.
- Recheck as above by cutting.

To adjust when marks are on stock cut on left side:

- Disengage bevel clamp handle. Do not pull bevel pin.
- Loosen right and left lock nuts.
- Loosen left set screw about 1/6 turn and tighten right set screw.
- Retighten lock nuts and bevel clamp handle.
- Recheck as above by cutting.

After left and right adjustments have been made, tilt the motor to 45° bevel cross-cut position and again make cuts on 2" x 4" stock as was done in cross-cut

position. If tooth marks again appear the motor is too high or low in the rear of the yoke.

To adjust when marks appear on bottom side of cut (left-hand piece of stock):

- Disengage bevel clamp handle. Do not pull bevel pin.
- Loosen all lock nuts.
- Loosen by equal amounts right and left set screws about 1/6 turn and tighten bottom set screw.
- Retighten lock nuts and bevel clamp handle and recheck as above by cutting.

To adjust when marks appear on upper side of cut:

- Disengage bevel clamp handle. Do not pull bevel pin.
- Loosen all lock nuts.
- Loosen bottom set screw about 1/6 turn and tighten right and left set screws.
- Retighten lock nuts and bevel clamp handle and recheck as above by cutting.

Now Go Back And Check Cross Cut Adjustments

*RIP SCALE POINTER

The rip scale is located on the right side of the radial arm. When the motor is positioned with motor arbor toward the column it is called "in rip" position, and material should be fed from right to left. When the motor arbor is positioned toward the operator it is called "out rip" and material is fed from left to right. When "in ripping" width dimensions are located on the top of the scale and when "out ripping" on the bottom of the scale by use of the reference pointers. The pointers are adjustable and must be readjusted only when gauge (thickness) of blade is changed.

To adjust:

To set the "in rip and "out rip" pointers, first set the saw in an "out rip" position and then set the saw blade at a predetermined distance from the fence. After you have done this loosen the two screws holding the pointer. Adjust the "out rip" pointer equal to the distance between the saw blade and the fence, and tighten the screws. Then turn the saw to an "in rip" position and push the blade against the fence. Adjust the "in rip" pointer to zero (0) on the scale.

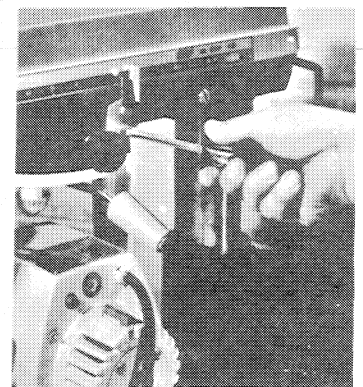

CUTTING KERF MARKS

OPTIONAL: Prior to cutting kerf marks you may elect to place a protective material over your table top. This material can easily be replaced as required without disturbing the saws alignment. Cut a piece of 1/4" plywood the same size as the front board and secure it to the front board with countersink 3/4" brads. Do not nail where the saw kerfs will be located. It is not necessary to cover the spacer or back boards.

After all your adjustments are made you should now cut into the table top the most common kerf marks. This will allow you to move the saw into different positions without changing the elevation. To do so proceed as follows:

- Locate and lock the arm 90° to the fence. Locate the blade 90° to the table.
- Draw the saw out to about the middle of the track and lower the blade until it just grazes the ply top.
- Turn the saw on and push the roller head all the way back. This will cut the fence and lightly score the ply top.
- Lower the arm (saw still running) 1/4 turn. Pull the saw forward to the end of the arm with your *left hand*. This will cut a groove in the table top 1/32" deep. **Tighten Rip Lock.** (Refer to figure 1)
- With the saw still running and your left hand still on the handle release the yoke lock with your right hand and pull it with sufficient strength so the yoke clamp handle presses against the yoke locator pin bell pulling the yoke locator pin out of the hole in the roller head. You can now rotate the saw blade in a clockwise direction. Release the pressure on the bell and continue rotating the blade until the spring mounted yoke locator pin falls into the next hole. You have now cut in the table top a 1/4 turn groove known as the swing line. The saw is now in the "in-rip" position. (Refer to figure 2) **Loosen Rip Lock.**
- Once the 1/4 turn cut is complete lock the yoke lock with your right hand and with the blade still revolving push the yoke back on the track until the blade reaches the fence. This will cut the rip trough in the center of the table. **Stop Motor.** (Refer to fig. 3)
- Return saw to position shown in figure 1. **Lock Rip Lock** and start motor. Using the yoke clamp handle, release the pressure on the bell and rotate saw counterclockwise, to the outtrip position. This cuts the swing line for outripping. Loosen rip lock.
- Lock the yoke lock (clamp handle), and with your right hand and blade still revolving, push the saw back until the new trough matches the trough cut in (f) **Stop Motor.**
- Return saw to position shown in figure 1 and move to the rear position behind the fence.
- Lock Rip Lock** and start motor. With motor running release the miter handle with your right hand and move arm to the 45° right hand miter position. This will cut a trough for mitering. (Optional step, not necessary if you're using 1/4" plywood on table top.) Repeat above for 45° left hand miter. **Stop Motor.**



FIGURE 1



FIGURE 2

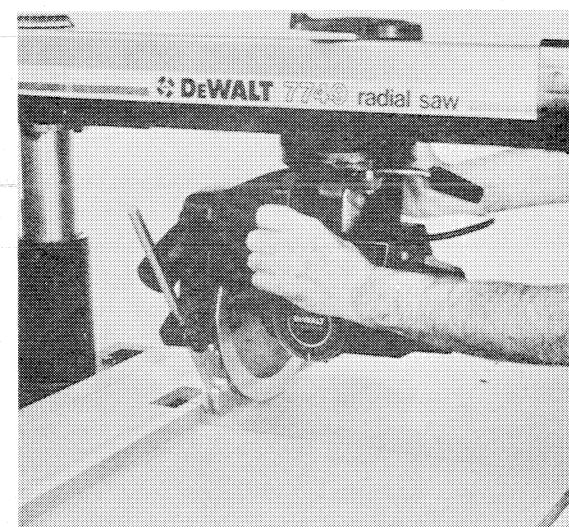

FIGURE 3

• OPERATING INSTRUCTIONS •

Observe and comply with the warning labels on the saw.

WARNING

FOR YOUR OWN SAFETY READ INSTRUCTION MANUAL BEFORE OPERATING SAW

- Wear eye protection.
- Keep hands out of path of saw blade.
- Return carriage to full rear position after each crosscut type of operation.
- Know how to reduce risk of kickback.
- Use pusher board for narrow work.
- Do not perform any operation freehand.
- Never reach around moving saw blade.
- Shut off power before clearing a stall or jam.
- Shut off power and wait for blade to stop before servicing tool.
- Do not operate without using proper guards.
- Have anti-kickback in place for all cuts.
- Do not wear gloves, jewelry, or loose clothing.

Use common sense, think all operations through before starting, and be alert.

Review the "Rules For Safer Operation of Stationary Power Tools" and "Maintenance and Operation" sections. (See index)

Keep saw in good adjustment and alignment; use only sharp, free-cutting tools and accessories that were designed for your machine. These precautions will help reduce the possibility of jam-ups or kickbacks.

Never perform any operation "free hand" (i.e. supporting the workpiece by hand alone). The workpiece must always be solidly supported or guided by the fence or supporting jig or fixture to prevent any unexpected movement.

If the sawblade or cutter becomes stalled or lower guard becomes jammed - **Turn off power immediately.** Never attempt to free a jam up without first turning power off. Remove workpiece and re-check machine alignment. Adjust as necessary.

DANGER Coasting cutting tools can be dangerous - apply the brake immediately on manual braking units to stop the tool as soon as the switch is turned off.

The torque developed during manual or automatic braking may loosen the blade retaining nut, therefore the arbor nut should be checked periodically and tightened if necessary.

Never cycle the tool "on" and "off" rapidly, as forces can be produced which will loosen the arbor nut.

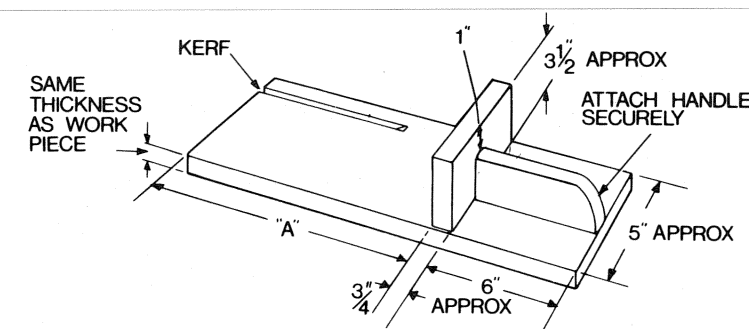

Dimension "A" must be such that the workpiece is fed completely past the blade but short enough to prevent the pusher board from passing under the anti-kickback device.

The pusher board should be pre-kerfed prior to use, for every new width of rip a new or re-worked pusher board must be used. Do not rip workpieces shorter than 12" in length.

DANGER

TO AVOID INJURY DO NOT FEED MATERIAL INTO CUTTING TOOL FROM THIS END



WARNING:

SHIM FRONT SAW LEGS TO PREVENT CARRIAGE FROM CREEPING TOWARD OPERATOR.

If the arbor nut should ever loosen, allow the blade to come to a complete stop and re-tighten the arbor nut securely, but not excessively, using both wrenches provided.

Read through and study the pictorial operating instructions which follow for further instructions before using your new DeWalt powershop.

Kickbacks can occur when the workpiece binds between the saw blade and the fence during a ripping type operation. Such action could cause the workpiece to be ejected from the machine and thrown violently back towards the operator.

Never stand, or permit someone else to stand in line with the work being ripped due to possible kickbacks.

The anti-kickback fingers must be kept sharp, free moving and correctly adjusted to insure proper operation.

Use extra care when ripping material that is twisted or bowed which can rock on the saw table and cause pinching or binding. Place the wood on the table in such a manner as to minimize rocking.

A pusher board should be used when ripping narrow work (i.e. less than 3 inches or so between the blade and fence). The pusher board should be made from clear, straight grained lumber as shown below.

It is easier to change the saw set-up and will prevent lower guard catching if work table is higher than rear table. 1/4" plywood and brads may be used.