

## Important

TO assure product SAFETY and RELIABILITY, repairs, maintenance and adjustment (including brush inspection and replacement) should be performed by Black & Decker Service Centers or other qualified organizations, always using Black & Decker replacement parts. When servicing Double Insulated Tools, **USE ONLY IDENTICAL REPLACEMENT PARTS.**

## Warranty

Black & Decker (U.S.) Inc. warrants this product for one year from the date of purchase. We will repair without charge, any defects due to faulty material or workmanship. Please return the complete unit, transportation prepaid, to any Black & Decker Service Center or Authorized Service Station listed under "Tools Electric" in the yellow pages. This warranty does not apply to accessories or damage caused where repairs have been made or attempted by others.

Like most Black & Decker tools, this tool is listed by Underwriters Laboratories to ensure that it meets stringent safety requirements.



This symbol on the nameplate means the product is listed by Underwriters Laboratories, Inc.



See 'Tools-Electric'  
-Yellow Pages-  
for Service & Sales

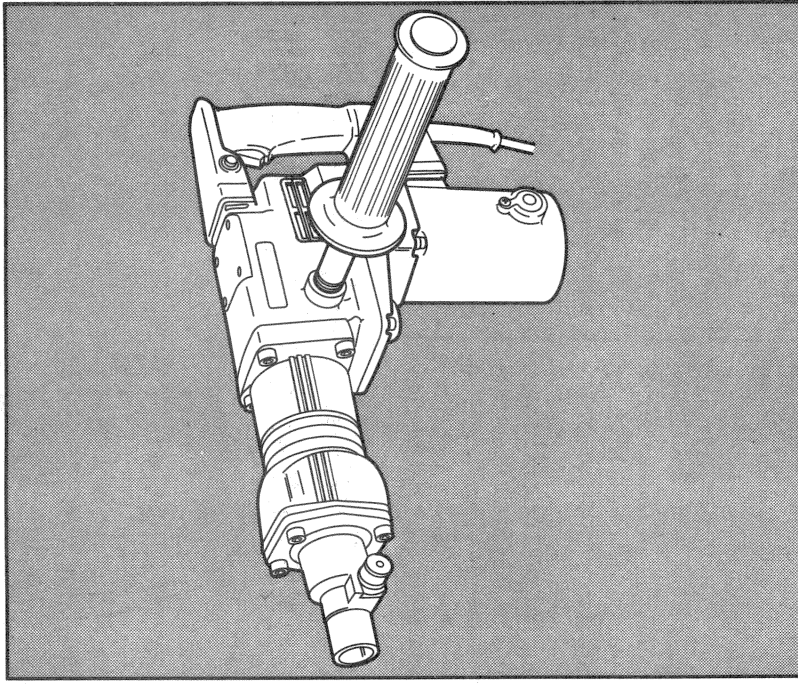

# Instruction Manual

## Rotary Hammer 5059

Form No. 741746  
©1989 Black & Decker  
Printed in Japan  
(FEB89)

Black & Decker (U.S.) Inc., U.S. Power Tools Group, 10 North Park Drive, P.O. 798, Hunt Valley, MD 21030-0798



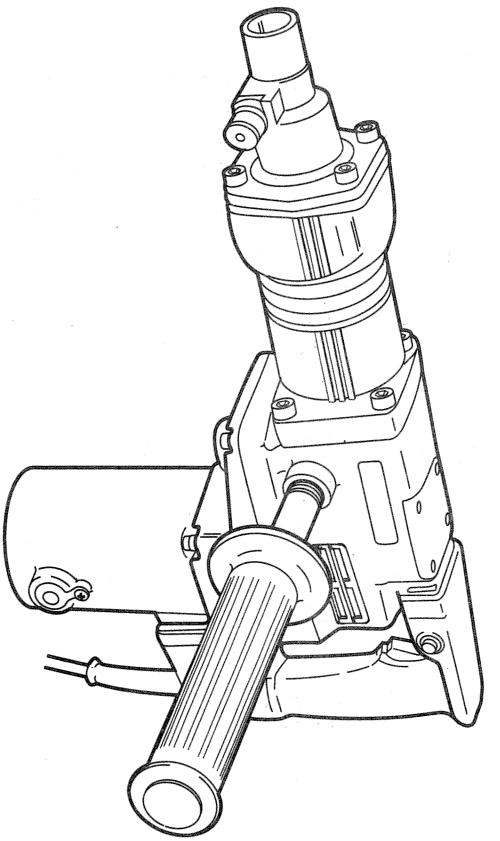

## Thanks for Buying a Black & Decker Rotary Hammer

If you already own a Black & Decker power tool, you know the pleasure of working with a real pro.

Built to the same rugged standards of quality that have made Black & Decker the world's choice for over seventy five years, your new hammer will give you years of dependable service.

With the proper accessories you can drill into the toughest concrete, brick, tile, stone and other masonry. Accessories are available for cutting asphalt,

grooving and edging and even scooping. All of this versatility and Black & Decker's inherent toughness make your new hammer every inch the pro that you are.

Please take the time to read this informative instruction manual and pay particular attention to the safety instructions we've provided for your protection.

Don't forget to send in your owner's registration card. Thanks, again for buying Black & Decker!



### Carbide Percussion Drilling Bits









Cat. No.	Diameter	Usable Length (Drilling Depth)	Overall Length
50158	3/8"	3"	8"
50188	3/8"	6"	11"
50159	7/16"	3"	8"
50160	1/2"	6"	11"
50161	1/2"	10"	15"
50162	1/2"	16"	21"
50184	1/2"	22"	27"
50189	1/2"	30"	35"
50163	9/16"	6"	11"
50164	5/8"	6"	11"
50165	5/8"	10"	15"
50166	5/8"	16"	21"
50185	5/8"	22"	27"
50191	5/8"	30"	35"
50167	11/16"	6"	11"
50168	3/4"	6"	11"
50169	3/4"	10"	15"
50170	3/4"	16"	21"
50186	3/4"	22"	27"
50171	13/16"	6"	11"
50187	27/32"	10"	15"
50172	7/8"	10"	15"
50173	7/8"	16"	21"
50174	7/8"	16"	21"
50175	1"	10"	15"
50192	1"	16"	21"
50192	1"	30"	35"
50176	1-1/8"	6"	11"
50193	1-1/8"	11"	16"
50177	1-1/8"	16"	21"
50178	1-1/4"	10"	15"
50179	1-1/4"	16"	21"
50180	1-3/8"	10"	15"
50181	1-3/8"	16"	21"
50182	1-1/2"	10"	15"
50183	1-1/2"	16"	21"
50194	1-3/4"	17"	22"
50195	2"	17"	22"

**WARNING:** When using Electric Tools, basic safety precautions should always be followed to reduce the risk of fire, electric shock, and personal injury, including the following:

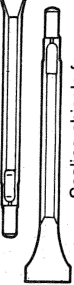
**READ ALL INSTRUCTIONS**

1. **KEEP WORK AREA CLEAN.** Cluttered areas and benches invite injuries.
2. **CONSIDER WORK AREA ENVIRONMENT.** Don't expose power tools to rain. Don't use power tools in damp or wet locations. Keep work area well lit. Don't use tool in presence of flammable liquids or gases. Power tools produce sparks during operation. They also spark when switching ON/OFF. Never use power tools in dangerous sites containing lacquer, paint, benzene, thinner, gasoline, gases, adhesive agents, and other materials which are combustible or explosive.
3. **GUARD AGAINST ELECTRIC SHOCK.** Prevent body contact with grounded surfaces. For example: pipes, radiators, ranges, refrigerator enclosures.
4. **KEEP CHILDREN AWAY.** Do not let visitors contact tool or extension cord. All visitors should be kept away from work area.
5. **STORE IDLE TOOLS.** When not in use, tools should be stored in dry, and high or locked-up place-out of reach of children.
6. **DON'T FORCE TOOL.** It will do the job better and safer at the rate for which it was intended.
7. **USE RIGHT TOOL.** Don't force small tool or attachment to do the job of a heavy-duty tool. Don't use tool for purpose not intended.
8. **DRESS PROPERLY.** Do not wear loose clothing or jewelry. They can be caught in moving parts. Rubber gloves and non-skid footwear are recommended when working outdoors. Wear protective hair covering to contain long hair.
9. **USE SAFETY GLASSES.** Also use face or dust mask if cutting operation is dusty. All persons in the area where power tools are being operated should also wear safety eye protection and face or dust masks.
10. **DON'T ABUSE CORD.** Never carry tool by cord or yank it to disconnect from receptacle. Keep cord from heat, oil, and sharp edges.
11. **SECURE WORK.** Use clamps or a vise to hold work. It's safer than using your hand and it frees both hands to operate tool.
12. **DON'T OVERREACH.** Keep proper footing and balance at all times.
13. **MAINTAIN TOOLS WITH CARE.** Keep tools sharp and clean for better and safer performance. Follow instructions for lubricating and changing accessories. Inspect tool cords periodically and if damaged, have repaired by authorized service facility. Inspect extension cords periodically and replace if damaged. Keep handles dry, clean, and free from oil and grease.
14. **DISCONNECT TOOLS.** When not in use, before servicing, and when changing accessories, such as blades, bits, cutters.
15. **REMOVE ADJUSTING KEYS AND WRENCHES.** Form habit of checking to see that keys and adjusting wrenches are removed from tool before turning it on.
16. **AVOID UNINTENTIONAL STARTING.** Don't carry plugged-in tool with finger on switch. Be sure switch is off when plugging in.
17. **OUTDOOR USE EXTENSION CORDS.** When tool is used outdoors, use only extension cords intended for use outdoors and so marked.
18. **STAY ALERT.** Watch what you are doing. Use common sense. Do not operate tool when you are tired.
19. **CHECK DAMAGED PARTS.** Before further use of the tool, a guard or other part that is damaged should be carefully checked to determine that it will operate properly and perform its intended function. Check for alignment of moving parts, binding of moving parts, breakage of parts, mounting, and any other conditions that may affect its operation. A guard or other part that is damaged should be properly repaired or

**Chipping/Demolition Bits (non-rotating)**

Hammer Tool	Macho
	Spline Shank
	50109 12
	50110 18
	50111 1-1/2 12
	50112 1-1/4 12
	50113 2 12
	50114 7/8 12
	50115 7/8 18
	50116 1-3/8 12

**Carbide Core Bits**

Core Body	Centering Bit	(Drive Type) Core Bit Shank
#50505 1-1/2" x 4"	#50514 4-3/4"	#50517 9" TE Shank
#50506 2" x 4"		#50518 16" TE Shank
#50124 2-1/4" x 4"		#50515 9" Spline Shank
#50507 2-1/2" x 4"		#50516 16" Spline Shank
#50508 3" x 4"		
#50509 3-1/2" x 4"		
#50512 4" x 4"		
#50513 5" x 4"		

#50470 Taper Ejector Pin

- replaced by an authorized service center unless otherwise indicated elsewhere in this instruction manual. Have defective switches replaced by authorized service center.
20. **AVOID USING A POWER TOOL FOR APPLICATIONS OTHER THAN THOSE SPECIFIED.** Never use a power tool for applications other than those specified in the instruction manual.
  21. **ENSURE SAFE OPERATION THROUGH CORRECT HANDLING.** Secure safe operation through correct handling by observing the instructions described herein. Do not employ accessories other than those specified herein; otherwise, a hazardous condition may be created. Never allow a power tool to be used by persons not familiar with correct handling (such as children) or by those who cannot handle the tool correctly.
  22. **CONFIRM THAT NO ITEMS SUCH AS AN ELECTRIC CABLE OR CONDUIT ARE BURIED INSIDE.** In places where live wiring may be hidden behind a wall, floor, ceiling, etc. do not hold or contact any metal parts of the tool. In such cases, metal parts could become electrically live and present a serious shock hazard.
  23. **KEEP THE RIGHT PARTS IN THE RIGHT POSITIONS.** Do not remove covers and screws which have been factory-mounted. They perform important respective roles. Keep them in the right positions.
  24. **SHOULD THE PLASTIC HOUSING OR HANDLE OF A POWER TOOL BE CRACKED OR DEFORMED, DO NOT USE IT.** Since cracked or deformed parts may lead to an operator receiving an electric shock, do not use such a power tool. Immediately have it repaired.
  25. **DO NOT WIPE PLASTIC PARTS WITH SOLVENT.** Solvents such as gasoline, thinner, benzene, carbon tetrachloride, and alcohol may damage and crack plastic parts. Do not wipe them with such solvents. Wipe plastic parts with a soft cloth lightly dampened with soapy water.
  26. **ALWAYS KEEP THE MOTOR AIR VENT FULLY CLEARED.** A constantly open motor air vent is necessary to allow air to come in and out for cooling the motor. Do not allow it to become clogged up, even if dust is blown through it.
  27. **OPERATE POWER TOOLS AT THE RATED VOLTAGE.** Operate power tools at voltages specified on their nameplates.
  28. **NEVER TOUCH THE MOVING PARTS.** Never touch the moving parts such as blades, bits, cutters and others.
  29. **STOP OPERATION IMMEDIATELY IF ANY ABNORMALITY IS DETECTED.** Should a power tool be detected as out of order or should other abnormalities be observed during operation, stop using the tool immediately.
  30. **NEVER LEAVE TOOL RUNNING UNATTENDED. TURN POWER OFF.** Don't leave tool until it comes to a complete stop.
  31. **CAREFULLY HANDLE POWER TOOLS.** Should a power tool be dropped or struck against hard materials inadvertently, it may be deformed, cracked, or damaged.

## SAVE THESE INSTRUCTIONS

- Black & Decker Service Center.)
5. Spread the grease around so that all parts under the Crank Cover get lubricated.
  6. Replace the Crank Cover and tighten securely.

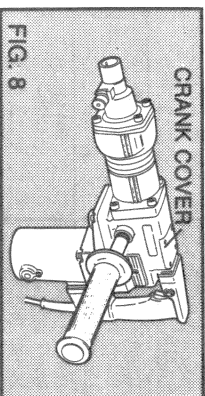

### Maintenance and Inspection

**CAUTION:** Be sure to switch power OFF and disconnect the plug during maintenance and inspection.

#### INSPECTING THE BIT

Since use of a dull bit will degrade efficiency and cause possible motor malfunction, sharpen or replace the bit as soon as wear is noted.

#### INSPECTING THE MOUNTING SCREWS

Regularly inspect all mounting screws and ensure that they are properly tightened. Should any of the screws be loose, retighten them immediately. Failure to do so could result in serious hazard.

#### INSPECTING THE CARBON BRUSHES (FIG. 9)

The motor employs carbon brushes which are consumable parts. When they become worn to or near "wear limit", it could result in motor trouble. When an auto-stop carbon brush is equipped, the motor

will stop automatically when the brushes are worn out. At that time, replace both carbon brushes with new ones. In addition, always keep carbon brushes clean and ensure that they slide freely within the brush holders.

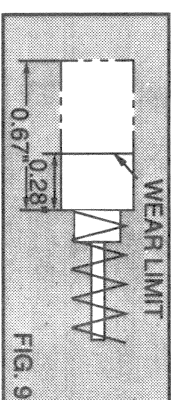

#### REPLACEMENT PROCEDURE

Loosen the set screw and remove the cap cover. Remove the brush cap and carbon brush. After replacing the carbon brush, do not forget to tighten the brush cap securely and to install the cap cover and screw.

### Accessories

**CAUTION:** Recommended accessories for this 5059K Rotary Hammer are listed in this manual. The use of any other attachment or accessory might be hazardous.

The accessories listed in this manual are available at extra cost from your local dealer or Black & Decker Service Center.

A complete listing of service centers is included on the owner's registration card packed with your tool.

If you need assistance in locating any accessory please contact:

Black & Decker (U.S.) Inc.  
 User Services Department  
 626 Hanover Pike  
 P.O. Box 618  
 Hampstead, MD 21074-0618

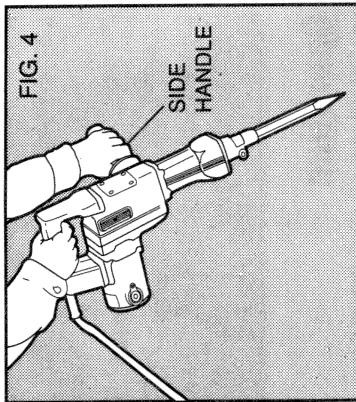

### DRILLING WITH CORE BITS

CORE BITS are made up of three components that must be purchased and assembled together before insertion into the hammer.

To assemble a core bit first coat the threads of the CORE BIT SHANK with medium weight machine oil to make disassembly easier. Screw the core bit down on the threads of the core bit shank, as shown in Figure 5. Install the partially assembled core bit into the hammer as you would any other bit.

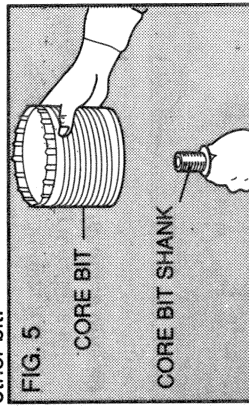

Install the Center Pin through the Core Bit Shank, as shown in Figure 6. Push it firmly into the end of the shank (its taper will prevent its falling out).

The Center Pin is used to prevent the the Core Bit from "walking" around on the work surface before it begins to drill. Once the hole is started, the Center Pin must be removed from the Core Bit Shank.

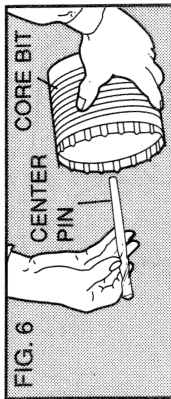

To remove the Center Pin, insert the tapered ejector pin, as shown in figure 7, into the slot in the Core Bit Shank. Strike the back of the pin sharply with a plastic hammer and the Center Pin will eject from the Core Bit Shank.

**CAUTION:** These parts become very hot during use; exercise care when handling them. Use pliers or gloves to prevent burning your hands.

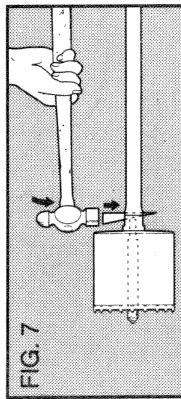

### Grease Replacement

The air tight construction of your hammer prevents most grease leakage so that the tool can be used for a long time without the need for grease replacement. About every 6 months you should clean out the grease and add a fresh supply.

To replace the grease supply, follow the steps below.

1. Turn off and unplug the hammer.
2. Remove the Crank Cover shown in Figure 8.
3. Use a clean rag to wipe out as much of the grease as practical.
4. Add .8 ounces of Black & Decker hammer grease.  
(Additional grease is available at extra cost from your dealer or

## Precaution On Using Demolition Hammer

1. Wear ear protection when using for extended periods.
2. Always attach the side handle and securely grip the Rotary Hammer.
3. Do not touch the tool bit with your bare hands after operation.
4. Do not wear gloves made of materials liable to roll up such as cotton, wool, cloth or string, etc.

## Double Insulation

DOUBLE-INSULATED tools are constructed throughout with TWO separate "layers" of electrical insulation or one DOUBLE thickness of insulation between you and the tool's electrical system.

Tools built with this insulation system are not intended to be grounded. As a result, your tool is equipped with a two-prong plug which permits you to use extension cords without concern for maintaining a ground connection.

**NOTE: DOUBLE INSULATION** does not take the place of normal safety precautions when operating this tool. The insulation system is for added protection against injury resulting from a possible electrical insulation failure within the tool.

**CAUTION:** When servicing all tools, **USE ONLY IDENTICAL REPLACEMENT PARTS.** Repair or replace damaged cords.

## Applications

1. Drilling holes in concrete.
2. Drilling anchor holes.
3. Crushing concrete, chipping, digging, and squaring (by applying optional accessories)

## Prior To Operation POWER SOURCE

Ensure that the power source to be utilized conforms to the power requirements specified on the product nameplate.

## POWER SWITCH

Ensure that the power switch is in the OFF position. If the plug is connected to a receptacle while the power switch is in the ON position, the tool will start operating immediately, inviting serious accident.

## EXTENSION CORD

When the work area is removed from the power source, use an extension cord of sufficient thickness and rated capacity. The extension cord should be kept as short as practicable.

**CAUTION:** Damaged cord must be replaced or repaired.

## CONFIRMING CONDITION OF THE ENVIRONMENT

Confirm that the work site is placed under appropriate conditions conforming to prescribed precautions.

## EXTENSION CORDS

Double-insulated tools have 2 wire cords, and can be used with 2 wire or 3 wire extension cords. Only round jacketed extension cords should be used. If the extension will be used outside, the cord must be suitable for outdoor use. Any cord marked as outdoor can also be used for indoor work. (The letters "WA" on the cord jacket indicate that the cord is suitable for outdoor use.)

An extension cord must have adequate wire size (AWG or American Wire Gauge) for safety, and to prevent loss of power and overheating. The smaller the gauge number of the wire, the greater the capacity of the cable, that is 14 gauge has more capacity than 16 gauge. When using more than one extension to make up the total length, be sure each individual extension contains at least the minimum wire size.

To determine the minimum wire size required, refer to the chart below:

CHART FOR MINIMUM WIRE SIZE (AWG) OF EXTENSION CORDS

NAMEPLATE RATING-AMPS	25	50	75	100	125	150	175	200
0 - 10.0	18	18	16	16	14	14	14	12
10.1 - 13.0	16	16	14	14	14	12	12	12
13.1 - 15.0	14	14	12	12	12	12	12	—

Before using an extension cord, inspect it for loose or exposed wires, damaged insulation, and defective fittings. Make any needed repairs or replace the cord if necessary. Black & Decker has extension cords available that are U.L. listed for outdoor use.

## HOW TO INSTALL THE DUST COVER

Always install the dust cover on the drill bit. Insert the dust cover until it lies flush in the groove.

**NOTE:** For a thick drill bit, insert the dust cover from drill rear.

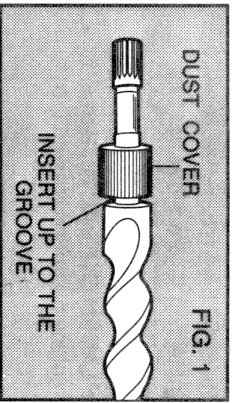

6

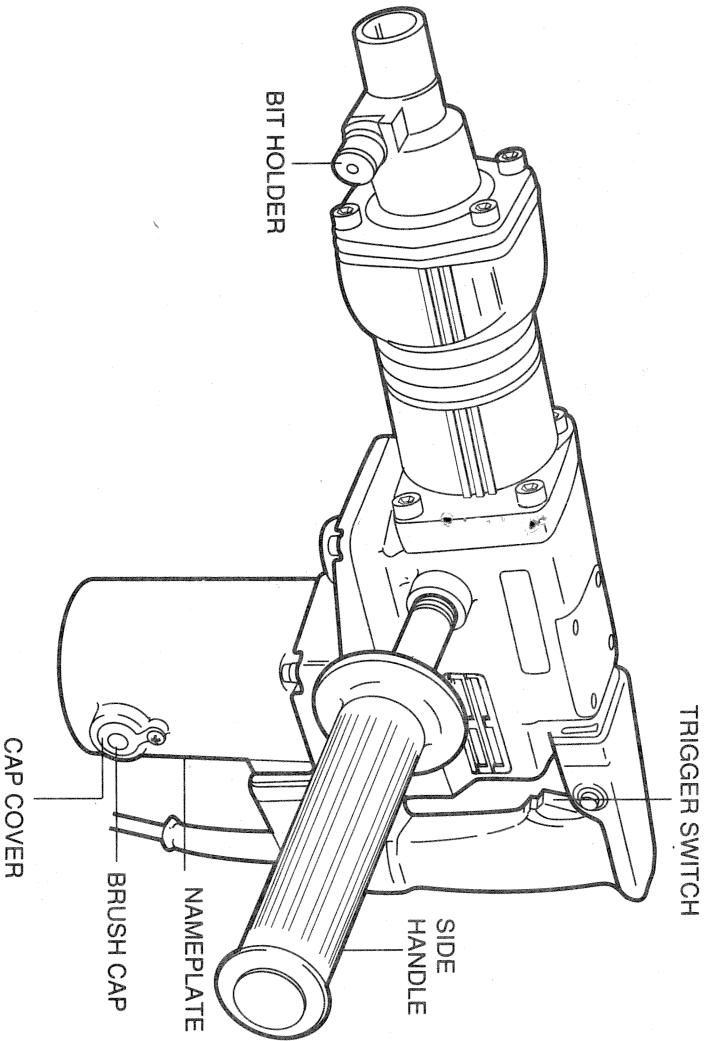

## HOW TO INSTALL BITS

1. Clean, then smear the bit shank with grease.
2. Pull out the bit holder in the direction of arrow A and rotate it 180°. Turn the notch of the bit shank downward and insert it fully into the hexagonal hole of the front cover. (Fig. 2)
3. Turn the bit holder and align the front cover mark with the bit holder mark to secure.

**NOTE:** Remove in the reverse order of installation.

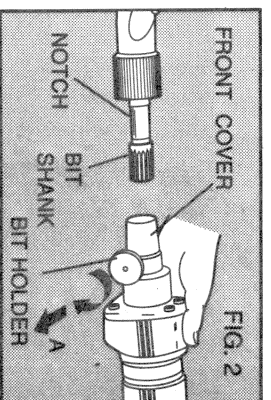

## Operation

(ALWAYS WEAR EYE PROTECTION)  
**ALWAYS USE THE SIDE HANDLE WITH YOUR HAMMER.**

## GENERAL DRILLING (FIGURE 4)

Before turning the tool on, locate the tip of the drill bit as desired. Rest the weight of the tool on the bit and turn the hammer on. Let the tool's weight work to your advantage; this will be easier and more efficient. Pushing on the tool only reduces efficiency.

Guide the tool, turning it off whenever changing locations in order to locate the bit at the desired spot.

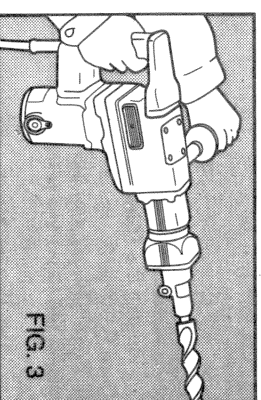

## CHIPPING OR CRUSHING

Use the hammer as in general drilling except use a demolition bit such as a bull point or cutting bit.

7