

Instruction Manual



25cc/1.5 cu.in. 2-Cycle

185 MPH/385 CFM

GASOLINE POWERED BLOWER

Model No.

358.794900

- **Safety**
- **Assembly**
- **Operation**
- **Maintenance**
- **Parts List**
- **Español**

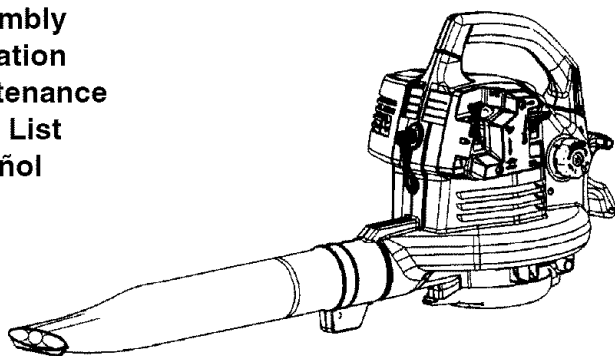

WARNING:

Read and follow all Safety Rules and Operating Instructions before first use of this product.



For answers to your questions about this product:
Call 7 am-7 pm, Mon.-Sat., or 10 am-7 pm, Sun.

1-800-235-5878

(Hours listed are Central Time)

Sears, Roebuck and Co., Hoffman Estates, IL 60179 U.S.A.

TABLE OF CONTENTS

Warranty Statement	2	Troubleshooting Table	10
Safety Rules	2	Emissions Statement	11
Assembly	4	Parts List	13
Operation	5	Spanish	15
Maintenance	7	Parts and Ordering	Back
Storage	9		

WARRANTY STATEMENT

FULL ONE YEAR WARRANTY ON CRAFTSMAN® GAS BLOWER

For one (1) year from date of purchase, when this Gas Blower is maintained, lubricated, and tuned up according to the instructions in this manual, Sears will repair, free of charge, any defects in material or workmanship.

This warranty excludes blower tubes, spark plug, and air cleaner, which are expendable parts and become worn during normal use.

If this blower is used for commercial purposes, this warranty applies for 90 days from the date of purchase. If this Blower is used for rental purposes, this warranty applies for 30 days from the date of purchase. This warranty applies only while this product is in use in the United States.

WARRANTY SERVICE IS AVAILABLE BY RETURNING THE BLOWER TO THE NEAREST SEARS STORE OR SERVICE CENTER IN THE UNITED STATES.

This warranty gives you specific legal rights, and you may also have other rights which vary from state to state.

Sears, Roebuck and Co., D/817WA, Hoffman Estates, IL 60179

SAFETY RULES

⚠ WARNING: Failure to follow all Safety Rules and Precautions can result in serious injury.

KNOW YOUR UNIT

- Read your instruction manual carefully until you completely understand and can follow all warnings and safety rules before operating the unit.
- Restrict unit to users who understand and will follow all warnings and safety rules in this manual.

⚠ WARNING: Inspect area before starting unit. Remove all debris and hard objects such as rocks, glass, wire, etc. that can ricochet, be thrown, or otherwise cause injury or damage during operation.

Use your unit as a blower for:

- Sweeping debris or grass clippings from driveways, sidewalks, patios, etc.
- Blowing grass clippings, straw, or leaves into piles, around joints, or between bricks.

PLAN AHEAD

- Always wear eye protection when operating, servicing, or performing maintenance on unit. Wearing eye protection will help to prevent rocks or debris from being blown or ricocheting into eyes and face which can result in blindness and/or serious injury. Eye protection should be marked Z87.
- Always wear foot protection. Do not go barefoot or wear sandals.
- Always wear respirator or face mask when working with unit in dusty environments.
- Secure hair above shoulder length. Secure or remove jewelry, loose clothing, or clothing with loosely hanging straps, ties, tassels, etc. They can be caught in moving parts.
- Do not operate unit when you are tired, ill, upset, or if you are under the influence of alcohol, drugs, or medication.
- Keep children, bystanders, and animals away from work area a minimum of 30 feet (10 meters) when starting or operating unit. Do not point blower nozzle in the direction of people or pets.

HANDLE FUEL WITH CAUTION, IT IS HIGHLY FLAMMABLE

- Eliminate all sources of sparks or flame (including smoking, open flames, or work that can cause sparks) in the areas where fuel is mixed, poured, or stored.
- Mix and pour fuel in an outdoor area; store fuel in a cool, dry, well ventilated place; use an approved, marked container for all fuel purposes.
- Do not smoke while handling fuel or while operating the unit.
- Make sure the unit is properly assembled and in good operating condition.
- Do not fill fuel tank while engine is running.
- Avoid spilling fuel or oil. Wipe up fuel spills before starting engine.
- Move at least 10 feet (3 meters) away from fuel and fueling site before starting engine.
- Always store gasoline in a container approved for flammable liquids.

OPERATE YOUR UNIT SAFELY

 **WARNING:** This unit is intended for blower use only. Do not attempt to open inlet cover. Opened or damaged inlet cover can result in serious injury. Discontinue use of blower immediately if inlet cover becomes opened or damaged. Take unit to your nearest Sears Service Center for repair.

- Inspect unit before each use for worn, loose, missing, or damaged parts. Do not use until unit is in proper working order.
- Keep outside surfaces free from oil and fuel.
- Never start or run engine inside a closed room, building or other unventilated area. Breathing exhaust fumes can kill.
- To avoid static electricity shock, do not wear rubber gloves or any other insulated gloves while operating unit.
- Do not set unit on any surface except a clean, hard area while engine is running. Debris such as gravel, sand, dust, grass, etc. could be picked up by the air intake and thrown out through discharge opening, damaging unit, property, or causing serious injury to bystanders or operator.
- Avoid dangerous environments. Do not use in unventilated areas or where explosive vapors or carbon monoxide build up could be present.

- Do not overreach or use from unstable surfaces such as ladders, trees, steep slopes, rooftops, etc. Keep firm footing and balance at all times.
- Never place objects inside the blower tubes; always direct the blowing debris away from people, animals, glass, and solid objects such as trees, automobiles, walls, etc. The force of air can cause rocks, dirt, or sticks to be thrown or to ricochet which can hurt people or animals, break glass, or cause other damage.
- Never run unit without the proper equipment attached. When using your unit as a blower, always install blower tubes.
- Check air intake opening and blower tubes frequently, always with engine stopped and spark plug disconnected. Keep vents and discharge tubes free of debris which can accumulate and restrict proper air flow.
- Never place any object in air intake opening as this could restrict proper air flow and cause damage to the unit.
- Never use for spreading chemicals, fertilizers, or other substances which may contain toxic materials.
- To avoid spreading fire, do not use near leaf or brush fires, fireplaces, barbecue pits, ashtrays, etc.
- Use only for jobs explained in this manual.

MAINTAIN YOUR UNIT PROPERLY

- Have all maintenance other than the recommended procedures described in the instruction manual performed by a Sears Service Center.
- Disconnect spark plug before performing maintenance except for carburetor adjustments.
- Use only recommended Craftsman® replacement parts; use of any other parts may void your warranty and cause damage to your unit.
- Empty fuel tank before storing the unit. Use up fuel left in carburetor by starting engine and letting it run until it stops.
- Do not use any accessory or attachment other than those recommended by manufacturer for use with your unit.
- Do not store the unit or fuel in a closed area where fuel vapors can reach sparks or an open flame from hot water heaters, electric motors or switches, furnaces, etc.
- Store in a dry area out of reach of children.

SAFETY NOTICE: Exposure to vibrations through prolonged use of gasoline powered hand tools could cause blood vessel or nerve damage in the fingers, hands, and joints of people prone to circulation disorders or abnormal swelling. Prolonged use in cold weather has been linked to blood vessel damage in otherwise healthy people. If symptoms occur such as numbness, pain, loss of strength, change in skin color or texture, or loss of feeling in the fingers, hands, or joints, discontinue the use of this tool and seek medical attention. An antivibration system does not guarantee the avoidance of these problems. Users who operate power tools on a continual and regular basis must monitor closely their physical condition and the condition of this tool.

SPECIAL NOTICE: For users on U.S. Forest Land and in some states, including California (Public Resources Codes

4442 and 4443), Idaho, Maine, Minnesota, New Jersey, Oregon, and Washington: Certain internal combustion engines operated on forest, brush, and/or grass covered land in the above areas are required to be equipped with a spark arresting screen, maintained in effective working order, or the engine must be constructed, equipped, and maintained for the prevention of fire. Check with your state or local authorities for regulations pertaining to these requirements. Failure to follow these requirements is a violation of the law. This unit is not factory equipped with a spark arresting screen; however, a spark arresting screen is available as an optional part. If a spark arresting screen is required in your area, contact Sears Service for the correct kit. The spark arresting screen, blower tubes, and nozzles must be assembled to unit to be in full compliance with regulations.

ASSEMBLY

CARTON CONTENTS

Check carton contents against the following list.

Model 358.794900

- Blower
- Blower tube
- 2-Cycle Engine Oil

NOTE: It is normal for the fuel filter to rattle in the empty fuel tank.

ASSEMBLY

⚠ WARNING: This unit is intended for blower use only. Do not attempt to open inlet cover. Opened or damaged inlet cover can result in serious injury. Discontinue use of blower immediately if inlet cover becomes opened or damaged. Take unit to your nearest Sears Service Center for repair.

⚠ WARNING: If you receive your unit assembled, repeat all steps to ensure your unit is properly assembled and all fasteners are secure.

BLOWER TUBE ASSEMBLY

1. Align the rib on the blower tube with the groove in the blower outlet; slide the tube into place.

NOTE: Knob must be loose enough to allow blower tube to be inserted in blower outlet. Loosen knob by turning counterclockwise.

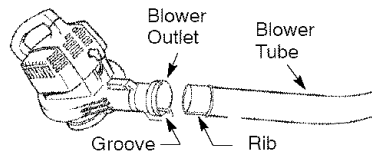

2. Secure the tube by turning the knob clockwise.
3. To remove the tube, turn the knob counterclockwise to loosen the tube; remove the tube.

OPERATION

KNOW YOUR BLOWER

READ THIS INSTRUCTION MANUAL AND SAFETY RULES BEFORE OPERATING YOUR UNIT. Compare the illustrations with your unit to familiarize yourself with the location of the various controls and adjustments. Save this manual for future reference.

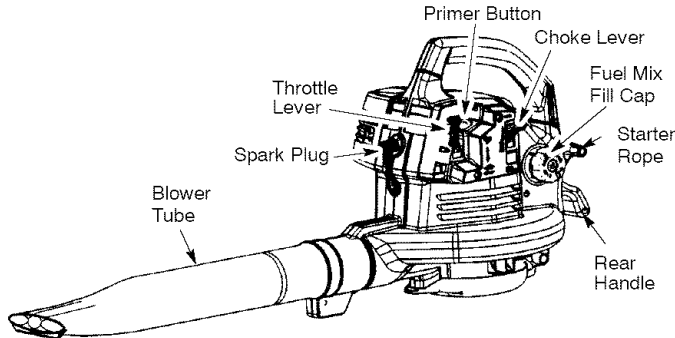

THROTTLE LEVER

The THROTTLE LEVER is used to select the desired engine speed and to stop the engine. Move the throttle lever to the  position for full speed operation.

Move the throttle lever to the  position for idle speed. To stop the engine, move the throttle lever to the STOP position.

PRIMER BUTTON

The PRIMER BUTTON removes air from the carburetor and fuel lines and fills them with fuel. This allows you to start

the engine with fewer pulls on the starter rope. Activate primer button by pressing it and allowing it to return to its original position.

CHOKE LEVER

The CHOKE helps to supply fuel to the engine to aid in cold starting. Activate the choke by moving the choke lever to the FULL CHOKE position. After engine attempts to start, move the choke lever to the HALF CHOKE position. Once engine starts, move choke lever to the RUN position.

OPERATING TIPS

- While blowing debris, hold the unit with the muffler side facing away from your body and clothes (see OPERATING POSITION below).
- To reduce the risk of hearing loss associated with sound level(s), hearing protection is required.
- To reduce the risk of injury associated with contacting rotating parts, stop the engine before installing or removing attachments. Do not operate without guard(s) in place.
- Operate power equipment only at reasonable hours—not early in the morning or late at night when people might be disturbed. Comply with times listed in local ordinances. Usual recommendations are 9:00 a.m. to 5:00 p.m., Monday through Saturday.
- To reduce noise levels, limit the number of pieces of equipment used at any one time.
- To reduce noise levels, operate power blowers at the lowest possible throttle speed to do the job.
- Use rakes and brooms to loosen debris before blowing.
- In dusty conditions, slightly dampen surfaces or use a mister attachment when water is available.
- Conserve water by using power blowers instead of hoses for many lawn and garden applications, including areas such as gutters, screens, patios, grills, porches, and gardens.
- Watch out for children, pets, open windows, or freshly washed cars. Blow debris away safely.
- Use the full blower nozzle extension so the air stream can work close to the ground.
- After using blowers and other equipment, CLEAN UP! Dispose of debris in trash receptacles.

OPERATING POSITION

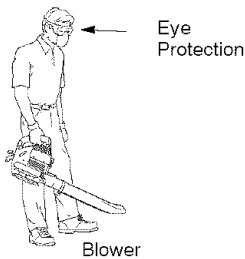

BEFORE STARTING ENGINE

⚠ WARNING: Be sure to read the fuel information in the safety rules before you begin. If you do not understand the safety rules, do not attempt to fuel your unit. Call 1-800-235-5878.

FUELING ENGINE

⚠ WARNING: Remove fuel cap slowly when refueling. This engine is certified to operate on unleaded gasoline. Before operation, gasoline must be mixed with a good quality synthetic 2-cycle air-cooled engine oil. We recommend Craftsman brand synthetic oil. Mix gasoline and oil at a ratio of 40:1. A 40:1 ratio is obtained by mixing 3.2 ounces of oil with 1 gallon of unleaded gasoline. Included with this blower is a 3.2 ounce container of oil. Pour the entire contents of this container into 1 gallon of gasoline to achieve the proper fuel mixture. **DO NOT USE** automotive oil or boat oil. These oils will cause engine damage. When mixing fuel, follow instructions printed on container. Once oil is added to gasoline, shake container momentarily to assure that the fuel is thoroughly mixed. Always read and follow the safety rules relating to fuel before fueling your unit.

IMPORTANT

Experience indicates that alcohol blended fuels (called gasohol or using ethanol or methanol) can attract moisture which leads to separation and formation of acids during storage. Acidic gas can damage the fuel system of an engine while in storage. To avoid engine problems, empty the fuel system before storage for 30 days or longer. Drain the gas tank, start the engine and let it run until the fuel lines and carburetor are empty. Use fresh fuel next season. Never use engine or carburetor cleaner

products in the fuel tank or permanent damage may occur. Fuel stabilizer is an acceptable alternative in minimizing the formation of fuel gum deposits during storage. Craftsman brand oil is already blended with fuel stabilizer. See the **STORAGE** section for additional information.

NOTE: Unit must be placed on its side when adding fuel (see illustration below).

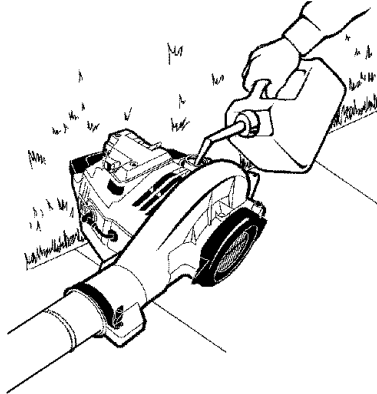

STOPPING YOUR ENGINE

- To stop the engine, move the throttle lever to the **STOP** position.

STARTING THE ENGINE

- ⚠ WARNING:** You **MUST** make sure the tubes are secure before using the unit.
- Fuel engine. Move at least 10 feet (3 meters) away from the fueling site.
 - Hold the unit in the starting position as shown. Make sure the blower end is directed away from people, animals, glass, and solid objects.

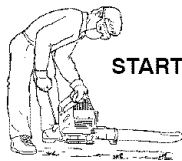

STARTING POSITION

⚠ WARNING: When starting engine, hold the unit as illustrated. Do not set unit on any surface except a clean, hard area when starting engine or while engine is running. Debris such as gravel, sand, dust, grass, etc. could be picked up by the air intake and thrown out through the discharge opening, damaging the unit or property, or causing serious injury to bystanders or the operator.

STARTING A COLD ENGINE

1. Move the throttle lever to the  position.
2. Move the choke lever to the FULL CHOKE position.
3. Slowly press the primer button 8 times.

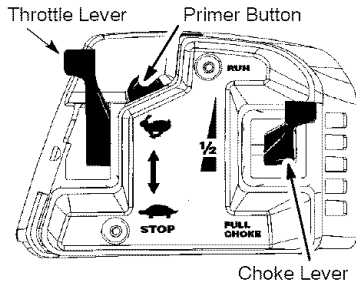

4. Pull starter handle sharply until the engine attempts to run, but no more than 5 pulls (below 30°F, 8 pulls).

NOTE: If the engine attempts to start before the 5th pull, go to the next step immediately.

5. Move choke lever to HALF CHOKE.
6. Pull the starter handle sharply until the engine runs, but no more than 5 pulls (below 30°F, 10 pulls).
7. After a 5 second warm-up, move the choke lever to the RUN position.
8. Allow the unit to run for 30 more seconds at RUN before moving the throttle lever to the  position.

If the engine has not started after 5 pulls (at HALF CHOKE), repeat the STARTING A COLD ENGINE procedure. If the engine still does not start, proceed to STARTING A FLOODED ENGINE.

9. To stop the engine, move the throttle lever to the STOP position.

STARTING A WARM ENGINE



NOTE: If fuel tank is empty, add fuel; then, follow STARTING A COLD ENGINE procedure. Do not fill fuel tank while engine is hot.

1. Move the throttle lever to the  position.
2. Pull the starter handle sharply until the engine starts, but no more than 5 pulls.

NOTE: If the engine has not started, pull starter handle sharply for 5 more pulls. If engine still does not run, it is probably flooded. Proceed to STARTING A FLOODED ENGINE.

3. To stop the engine, move the throttle lever to the STOP position.

STARTING A FLOODED ENGINE

Flooded engines can be started by placing the choke lever in the RUN position. Move throttle lever to the fast position ; then, pull rope until engine starts. After engine starts, move the throttle lever to the slow position  to allow engine to idle.

Starting could require pulling the starter rope many times depending on how badly the unit is flooded. If the unit still doesn't start, refer to the TROUBLESHOOTING TABLE or call 1-800-235-5878.

MAINTENANCE

CUSTOMER RESPONSIBILITIES

⚠ WARNING: Disconnect the spark plug before performing maintenance, service, or adjustments.

CARE & MAINTENANCE TASK	WHEN TO PERFORM
Check for loose fasteners and parts	Before each use
Check for damaged or worn parts	Before each use
Inspect and clean unit and labels	After each use
Clean air filter	Every 5 hours of operation
Replace spark plug	Yearly
Replace fuel filter	Yearly
Check muffler mounting screws	Yearly

⚠ WARNING: Avoid touching muffler unless engine and muffler are cold. A hot muffler can cause serious burns.

⚠ WARNING: This unit is intended for blower use only. Do not attempt to open inlet cover. Opened or damaged

inlet cover can result in serious injury. Discontinue use of blower immediately if inlet cover becomes opened or damaged. Take unit to your nearest Sears Service Center for repair.

GENERAL RECOMMENDATIONS

The warranty on this unit does not cover items that have been subjected to operator abuse or negligence. To receive full value from the warranty, the operator must maintain unit as instructed in this manual. Various adjustments will need to be made periodically to properly maintain your unit.

CHECK FOR LOOSE FASTENERS AND PARTS

- Spark Plug Boot
- Air Filter
- Housing Screws

CHECK FOR DAMAGED OR WORN PARTS

Contact Sears Service Center for replacement of damaged or worn parts.

- Throttle Lever - Ensure throttle lever functions properly by moving the throttle lever to the STOP position. Make sure engine stops; then restart engine and continue.
- Fuel Tank - Do not use unit if fuel tank shows signs of damage or leaks.

INSPECT AND CLEAN UNIT AND LABELS

- After each use, inspect complete unit for loose or damaged parts. Clean the unit using a damp cloth with a mild detergent.
- Wipe off unit with a clean dry cloth.

CLEAN AIR FILTER

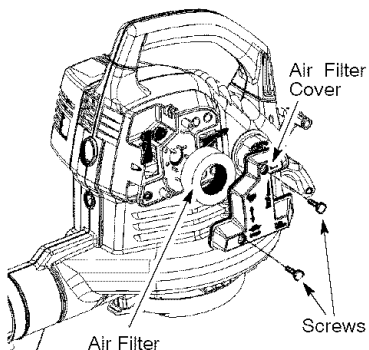

A dirty air filter decreases engine performance and increases fuel consumption and harmful emissions. Always clean after every 5 hours of operation.

Cleaning the air filter:

1. Clean the cover and the area around it to keep debris from falling into the carburetor chamber when the cover is removed.
 2. Remove parts as illustrated.
- NOTE:** Do not clean filter in gasoline or other flammable solvent. Doing so can create a fire hazard or produce harmful evaporative emissions.
3. Wash the filter in soap and water.
 4. Allow filter to dry.
 5. Apply a few drops of oil to the filter; squeeze filter to distribute oil.
 6. Replace parts.

REPLACE SPARK PLUG

Replace spark plug each year to ensure the engine starts easier and runs better. Set spark plug gap at 0.025 inch. Ignition timing is fixed, nonadjustable.

1. Twist, then pull off spark plug boot.
2. Remove spark plug from cylinder and discard.
3. Replace with Champion CJ-6Y spark plug and tighten securely with a 3/4 inch socket wrench.
4. Reinstall the spark plug boot.

REPLACE FUEL FILTER

To replace fuel filter, drain unit by running it dry of fuel, then remove fuel cap/retainer assembly from tank. Pull filter from tank and remove it from the fuel line. Install new fuel filter on fuel line; reinstall parts.

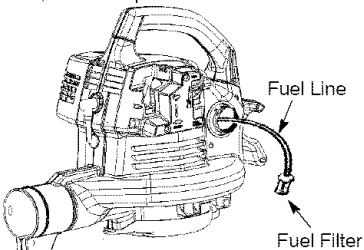

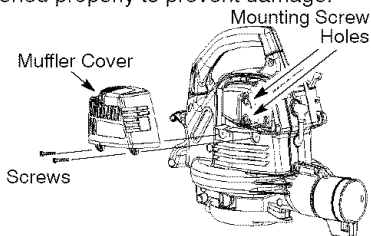

CHECK MUFFLER MOUNTING SCREWS

Once each year, ensure muffler mounting screws are secure and tightened properly to prevent damage.



1. Loosen and remove the 2 screws from the muffler cover.
2. Remove the muffler cover.
3. Tighten the 2 muffler mounting screws securely.
4. Reinstall muffler cover and 2 screws. Tighten securely.

CARBURETOR ADJUSTMENT

There is no screw for idle adjustment on your blower. The throttle lever is used to control engine speed. The throttle lever can be placed in one of four positions: STOP, IDLE or , FULL THROTTLE or , and one intermittent position. If your engine will not run properly or you require further assistance, contact your Sears Service Center or call our customer assistance help line at 1-800-235-5878.

STORAGE

 **WARNING:** Perform the following steps after each use:

- Allow engine to cool, and secure the unit before storing or transporting.
- Store unit and fuel in a well ventilated area where fuel vapors cannot reach sparks or open flames from water heaters, electric motors or switches, furnaces, etc.
- Store unit with all guards in place. Position unit so that any sharp object cannot accidentally cause injury.
- Store unit and fuel well out of the reach of children.

SEASONAL STORAGE

Prepare unit for storage at end of season or if it will not be used for 30 days or more.

If your unit is to be stored for a period of time:

- Clean the entire unit before lengthy storage.
- Store in a clean dry area.
- Lightly oil external metal surfaces.

FUEL SYSTEM

Under FUELING ENGINE in the OPERATION section of this manual, see message labeled **IMPORTANT** regarding the use of gasohol in your engine.

Fuel stabilizer is an acceptable alternative in minimizing the formation of fuel gum deposits during storage. Add stabilizer to gasoline in fuel tank or fuel storage container. Follow the mix instructions found on stabilizer container. Run engine at least 5 minutes after adding stabilizer.

Craftsman 40:1, 2-cycle engine oil (air cooled) is already blended with fuel stabilizer. If you do not use this Sears oil, you can add a fuel stabilizer to your fuel tank.

ENGINE

- Remove spark plug and pour 1 teaspoon of 40:1, 2-cycle engine oil (air cooled) through the spark plug opening. Slowly pull the starter rope 8 to 10 times to distribute oil.
- Replace spark plug with new one of recommended type and heat range.
- Clean air filter.
- Check entire unit for loose screws, nuts, and bolts. Replace any damaged, broken, or worn parts.
- At the beginning of the next season, use only fresh fuel having the proper gasoline to oil ratio.

OTHER

- Do not store gasoline from one season to another.
- Replace your gasoline can if it starts to rust.

TROUBLESHOOTING TABLE

⚠ WARNING: Always stop unit and disconnect spark plug before performing any of the recommended remedies below other than remedies that require operation of the unit.

TROUBLE	CAUSE	REMEDY
Engine will not start.	<ol style="list-style-type: none"> 1. Engine flooded. 2. Fuel tank empty. 3. Spark plug not firing. 4. Fuel not reaching carburetor. 5. Compression low. 	<ol style="list-style-type: none"> 1. See "Starting a Flooded Engine" in Operation section. 2. Fill tank with correct fuel mixture. 3. Install new spark plug. 4. Check for dirty fuel filter; replace. Check for kinked or split fuel line; repair or replace. 5. Contact Sears Service (see back cover).
Engine will not idle properly.	<ol style="list-style-type: none"> 1. Fuel not reaching carburetor. 2. Carburetor requires adjustment. 3. Crankshaft seals worn. 4. Compression low. 	<ol style="list-style-type: none"> 1. Check for dirty fuel filter; replace. Check for kinked or split fuel line; repair or replace. 2. Contact Sears Service (see back cover). 3. Contact Sears Service (see back cover). 4. Contact Sears Service (see back cover).
Engine will not accelerate, lacks power, or dies under a load.	<ol style="list-style-type: none"> 1. Air filter dirty. 2. Fuel not reaching carburetor. 3. Spark plug fouled. 4. Carburetor requires adjustment. 5. Carbon build up. 6. Compression low. 	<ol style="list-style-type: none"> 1. Clean or replace air filter. 2. Check for dirty fuel filter; replace. Check for kinked or split fuel line; repair or replace. 3. Clean or replace spark plug and re-gap. 4. Contact Sears Service (see back cover). 5. Contact Sears Service (see back cover). 6. Contact Sears Service (see back cover).
Engine smokes excessively.	<ol style="list-style-type: none"> 1. Choke partially on. 2. Fuel mixture incorrect. 3. Air filter dirty. 4. Carburetor requires adjustment. 	<ol style="list-style-type: none"> 1. Adjust choke. 2. Empty fuel tank and refill with correct fuel mixture. 3. Clean or replace air filter. 4. Contact Sears Service (see back cover).
Engine runs hot.	<ol style="list-style-type: none"> 1. Fuel mixture incorrect. 2. Spark plug incorrect. 3. Carburetor requires adjustment. 4. Carbon build up. 	<ol style="list-style-type: none"> 1. See "Fueling Engine" in Operation section. 2. Replace with correct spark plug. 3. Contact Sears Service (see back cover). 4. Contact Sears Service (see back cover).

U.S. EPA/CALIFORNIA EMISSION CONTROL WARRANTY STATEMENT

YOUR WARRANTY RIGHTS AND OBLIGATIONS:

The U.S. Environmental Protection Agency/California Air Resources Board and Sears, Roebuck and Co., U.S.A., are pleased to explain the emissions control system warranty on your year 2005 and later small off-road engine. In California, all small off-road engines must be designed, built, and equipped to meet the State's stringent anti-smog standards. Sears must warrant the emission control system on your small off-road engine for the periods of time listed below provided there has been no abuse, neglect, or improper maintenance of your small off-road engine. Your emission control system includes parts such as the carburetor and the ignition system. Where a warrantable condition exists, Sears will repair your small off-road engine at no cost to you. Expenses covered under warranty include diagnosis, parts and labor.

MANUFACTURER'S WARRANTY COVERAGE:

If any emissions related part on your engine (as listed under Emissions Control Warranty Parts List) is defective or a defect in the materials or workmanship of the engine causes the failure of such an emission related part, the part will be repaired or replaced by Sears.

OWNER'S WARRANTY RESPONSIBILITIES:

As the small off-road engine owner, you are responsible for the performance of the required maintenance listed in your instruction manual. Sears recommends that you retain all receipts covering maintenance on your small off-road engine, but Sears cannot deny warranty solely for the lack of receipts or for your failure to ensure the performance of all scheduled maintenance. As the small off-road engine owner, you should be aware that Sears may deny you warranty coverage if your small off-road engine or a part of it has failed due to abuse, neglect, improper maintenance, unapproved modifications, or the use of parts not made or approved by the original equipment manufacturer. You are responsible for presenting your small off-road engine to a Sears authorized repair center as soon as a problem exists. Warranty repairs

should be completed in a reasonable amount of time, not to exceed 30 days. If you have any questions regarding your warranty rights and responsibilities, you should contact your nearest authorized service center or call Sears at 1-800-469-4663.

WARRANTY COMMENCEMENT DATE: The warranty period begins on the date the small off-road engine is purchased.

LENGTH OF COVERAGE: This warranty shall be for a period of two years from the initial date of purchase.

WHAT IS COVERED: REPAIR OR REPLACEMENT OF PARTS. Repair or replacement of any warranted part will be performed at no charge to the owner at an approved Sears Service Center. If you have any questions regarding your warranty rights and responsibilities, you should contact your nearest authorized service center or call Sears at 1-800-469-4663.

WARRANTY PERIOD: Any warranted part which is not scheduled for replacement as required maintenance, or which is scheduled only for regular inspection to the effect of "repair or replace as necessary" shall be warranted for 2 years. Any warranted part which is scheduled for replacement as required maintenance shall be warranted for the period of time up to the first scheduled replacement point for that part.

DIAGNOSIS: The owner shall not be charged for diagnostic labor which leads to the determination that a warranted part is defective if the diagnostic work is performed at an approved Sears Service Center.

CONSEQUENTIAL DAMAGES: Sears may be liable for damages to other engine components caused by the failure of a warranted part still under warranty.

WHAT IS NOT COVERED: All failures caused by abuse, neglect, or improper maintenance are not covered.

ADD-ON OR MODIFIED PARTS: The use of add-on or modified parts can be grounds for disallowing a warranty claim. Sears is not liable to cover failures of warranted parts caused by the use of add-on or modified parts.

HOW TO FILE A CLAIM: If you have any questions regarding your warranty rights and responsibilities, you should contact your nearest authorized ser-

vice center or call Sears at 1-800-469-4663. **WHERE TO GET WARRANTY SERVICE:** Warranty services or repairs shall be provided at all Sears Service Centers. Call 1-800-469-4663.

MAINTENANCE, REPLACEMENT AND REPAIR OF EMISSION RELATED PARTS: Any Sears approved replacement part used in the performance of any warranty maintenance or repair on emission related parts will

be provided without charge to the owner if the part is under warranty. **EMISSION CONTROL WARRANTY PARTS LIST:** Carburetor, Ignition System: Spark Plug (covered up to maintenance schedule), Ignition Module, Muffler including catalyst. **MAINTENANCE STATEMENT:** The owner is responsible for the performance of all required maintenance as defined in the instruction manual.

The information on the product label indicates to which standard your engine is certified. Example: (Year) EPA Phase I or Phase II and/or CALIFORNIA.

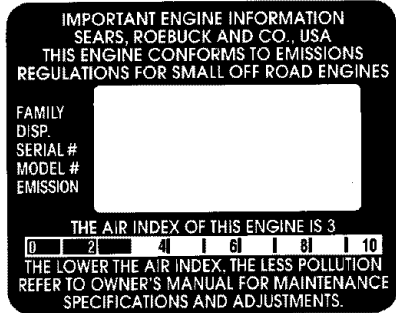

This engine is certified to be emissions compliant for the following use:

- Moderate (50 hours)
- Intermediate (125 hours)
- Extended (300 hours)