

# Operator's Manual



## LAWN TRACTOR

17.5 HP,\* 30" Mower

Electric Start

Automatic Transmission

Model No.

**917.98633**

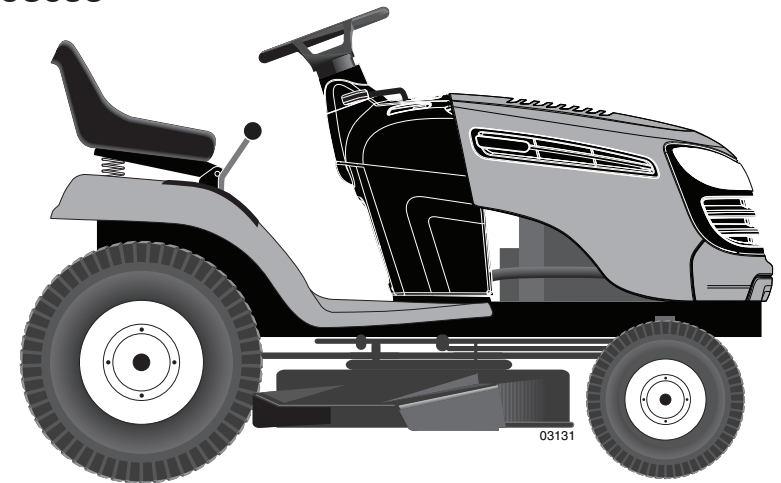

**This product has a low emission engine which operates differently from previously built engines. Before you start the engine, read and understand this manual.**

### **IMPORTANT:**

Read and follow all Safety Rules and Instructions before operating this equipment.

Sears Brands Management Corporation, Hoffman Estates, IL 60179 U.S.A.  
Visit our Craftsman website: [www.craftsman.com](http://www.craftsman.com)

\* The power rating as declared by the engine manufacturer is the average gross power output at the specified RPM of a typical production engine for the engine model measured using SAE Standards for engine gross power. Please refer to the engine manufacturer for details.

## TABLE OF CONTENTS

Warranty .....	2	Maintenance Schedule .....	18
Safety Rules .....	3	Maintenance .....	18
Product Specifications .....	6	Service and Adjustments .....	23
Assembly/Pre-Operation .....	8	Storage .....	30
Operation .....	11	Troubleshooting .....	31

## WARRANTY

### CRAFTSMAN FULL WARRANTY TWO YEARS ON RIDING EQUIPMENT

When operated and maintained according to all supplied instructions, Warranty will also cover defects in material and workmanship of the Frame and Front Axle for five years from the date of purchase

**This warranty covers ONLY defects in material and workmanship. Sears will NOT pay for:**

- Expendable items that become worn during normal use, including but not limited to blades, spark plugs, air cleaners, belts, and oil filters.
- Standard maintenance servicing, oil changes, or tune-ups.
- Tire replacement or repair caused by punctures from outside objects, such as nails, thorns, stumps, or glass.
- Tire or wheel replacement or repair resulting from normal wear, accident, or improper operation or maintenance.
- Repairs necessary because of operator abuse, including but not limited to damage caused by towing objects beyond the capability of the riding equipment, impacting objects that bend the frame or crankshaft, or over-speeding the engine.
- Repairs necessary because of operator negligence, including but not limited to, electrical and mechanical damage caused by improper storage, failure to use the proper grade and amount of engine oil, failure to keep the deck clear of flammable debris, or failure to maintain the riding equipment according to the instructions contained in the operator's manual.
- Engine (fuel system) cleaning or repairs caused by fuel determined to be contaminated or oxidized (stale). In general, fuel should be used within 30 days of its purchase date.
- Normal deterioration and wear of the exterior finishes, or product label replacement.

All riding equipment and battery warranty coverage is void if this product is ever used for commercial or rental purposes.

This warranty applies only while this product is within the United States.

This warranty gives you specific legal rights, and you may also have other rights which vary from state to state.

**Sears Brands Management Corporation, Hoffman Estates, IL 60179**

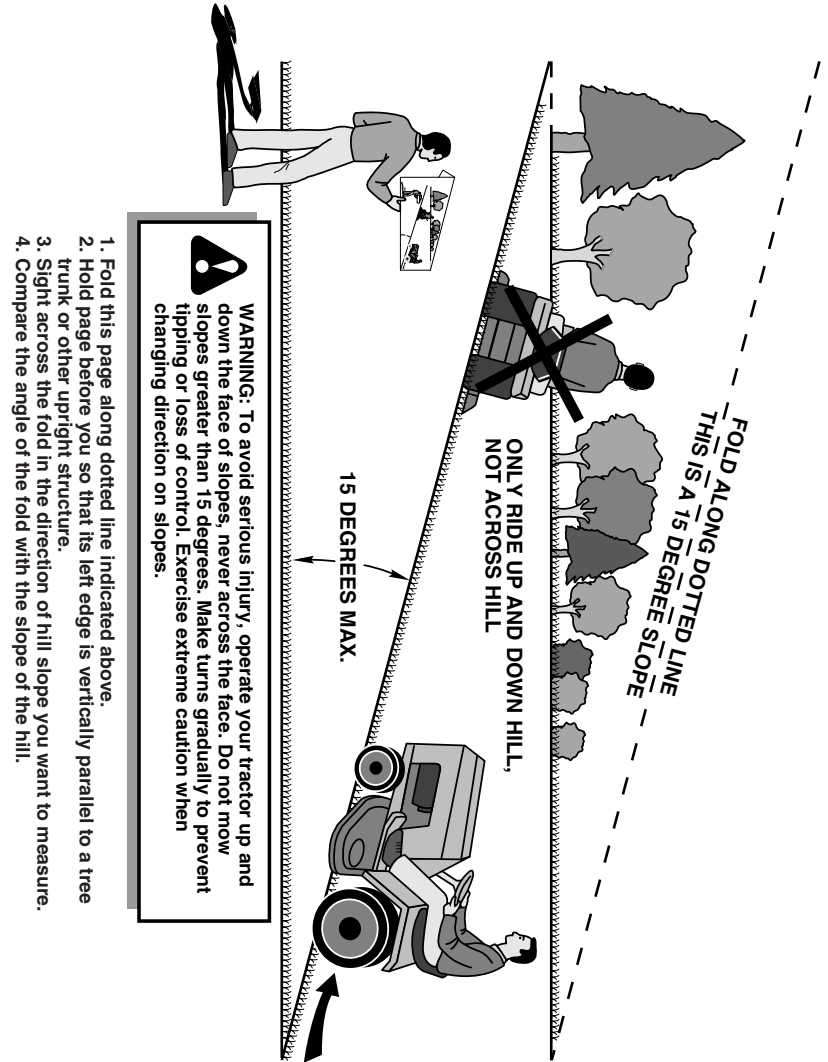

## TROUBLESHOOTING CHART:

See appropriate section in manual unless directed to Sears service center.

PROBLEM	CAUSE	CORRECTION
<b>Battery will not charge</b>	1 Bad battery cell(s).	1 Replace battery.
	2 Poor cable connections.	2 Check/clean all connections.
	3 Faulty regulator (if so equipped).	3 Replace regulator.
	4 Faulty alternator.	4 Replace alternator.
<b>Loss of drive</b>	1 Freewheel control in "DISENGAGED" position.	1 Place freewheel control in "ENGAGED" position.
	2 Debris on steering plate (if equipped).	2 See "CLEANING" in the maintenance section.
	3 Motion drive belt worn, damaged, or broken.	3 Replace motion drive belt.
	4 Air trapped in transmission during shipment or servicing.	4 Purge transmission.
	5 Axle key missing.	5 Install axle key at rear wheel. See "TO REMOVE WHEEL" in the Service and Adjustments section.
<b>Engine "backfires" when turning engine "OFF"</b>	1 Engine throttle control not set between half and full speed (fast) position before stopping engine.	1 Move throttle control between half and full speed (fast) position before stopping engine.
<b>Engine dies when tractor is shifted into reverse</b>	1 Reverse operation system (ROS) is not "ON" while mower or other attachment is engaged.	1 Turn ignition key to ROS "ON" position. See Operation section.

## SAFETY RULES

**⚠ DANGER:** This cutting machine is capable of amputating hands and feet and throwing objects. Failure to observe the following safety instructions could result in serious injury or death.

**⚠ WARNING:** In order to prevent accidental starting when setting up, transporting, adjusting or making repairs, always disconnect spark plug wire and place wire where it cannot contact spark plug.

**⚠ WARNING:** Do not coast down a hill in neutral, you may lose control of the tractor.

**⚠ WARNING:** Tow only the attachments that are recommended by and comply with specifications of the manufacturer of your tractor. Use common sense when towing. Operate only at the lowest possible speed when on a slope. Too heavy of a load, while on a slope, is dangerous. Tires can lose traction with the ground and cause you to lose control of your tractor.

**⚠ WARNING:** Engine exhaust, some of its constituents, and certain vehicle components contain or emit chemicals known to the State of California to cause cancer and birth defects or other reproductive harm.

**⚠ WARNING:** Battery posts, terminals and related accessories contain lead and lead compounds, chemicals known to the State of California to cause cancer and birth defects or other reproductive harm. **Wash hands after handling.**

### I. CHILDREN

**⚠ WARNING!** CHILDREN CAN BE INJURED BY THIS EQUIPMENT. The American Academy of Pediatrics recommends that children be a minimum of 12 year of age before operating a pedestrian controlled lawn mower and a minimum of 16 years of age before operating a riding lawn mower.

**⚠ WARNING!** CHILDREN CAN BE SERIOUSLY INJURED OR KILLED BY THIS EQUIPMENT. Carefully read and follow all of the safety instructions below.

Tragic accidents can occur if the operator is not alert to the presence of children. Children are often attracted to the machine and the mowing activity. Never assume that children will remain where you last saw them.

- Keep children out of the mowing area and in the watchful care of a responsible adult **other than** the operator.
- Be alert and turn machine off if a child enters the area.
- Before and while backing, look behind and down for small children.
- Never carry children, even with the blades shut off. They may fall off and be seriously injured or interfere with safe machine operation. Children who have been given rides in the past may suddenly appear in the mowing area for another ride and be run over or backed over by the machine.
- Never allow children to operate the machine.
- Use extreme caution when approaching blind corners, shrubs, trees, or other objects that may block your view of a child.

### II. GENERAL OPERATION

- Read, understand, and follow all instructions on the machine and in the manual before starting.
- Do not put hands or feet near rotating parts or under the machine. Keep clear of the discharge opening at all times.
- Only allow responsible adults, who are familiar with the instructions, to operate the machine.
- Clear the area of objects such as rocks, toys, wire, etc., which could be picked up and thrown by the blades.
- Ensure the area is clear of bystanders before operating. Stop machine if anyone enters the area.
- Never carry passengers.
- Do not mow in reverse unless absolutely necessary. Always look down and behind before and while backing.
- Never direct discharged material toward anyone. Avoid discharging material against a wall or obstruction. Material may ricochet back toward the operator. Stop the blades when crossing gravel surfaces.
- Do not operate machine without the entire grass catcher, discharge chute, or other safety devices in place and working.

## SAFETY RULES

- Slow down before turning.
- Never leave a running machine unattended. Always turn off blades, set parking brake, stop engine, and remove keys before dismounting.
- Disengage blades when not mowing. Shut off engine and wait for all parts to come to a complete stop before cleaning the machine, removing the grass catcher, or unclogging the discharge chute.
- Operate machine only in daylight or good artificial light.
- Do not operate the machine while under the influence of alcohol or drugs.
- Watch for traffic when operating near or crossing roadways.
- Use extreme caution when loading or unloading the machine into a trailer or truck.
- Always wear eye protection when operating machine.
- Use ear protectors to avoid damage to hearing.
- Data indicates that operators, age 60 years and above, are involved in a large percentage of riding mower-related injuries. These operators should evaluate their ability to operate the riding mower safely enough to protect themselves and others from serious injury.
- Follow the manufacturer's recommendation for wheel weights or counterweights.
- Keep machine free of grass, leaves or other debris build-up which can touch hot exhaust / engine parts and burn. Do not allow the mower deck to plow leaves or other debris which can cause build-up to occur. Clean any oil or fuel spillage before operating or storing the machine. Allow machine to cool before storage.
- Watch for holes, ruts, bumps, rocks, or other hidden objects. Uneven terrain could overturn the machine. Tall grass can hide obstacles.
- Choose a low ground speed so that you will not have to stop or shift while on the slope.
- Do not mow on wet grass. Tires may lose traction. Always keep the machine in gear when going down slopes.
- Do not shift to neutral and coast downhill.
- Avoid starting, stopping, or turning on a slope. If the tires lose traction, disengage the blades and proceed slowly straight down the slope.
- Keep all movement on the slopes slow and gradual. Do not make sudden changes in speed or direction, which could cause the machine to roll over.
- Use extreme caution while operating machine with grass catchers or other attachments; they can affect the stability of the machine. Do no use on steep slopes.
- Do not try to stabilize the machine by putting your foot on the ground.
- Do not mow near drop-offs, ditches, or embankments. The machine could suddenly roll over if a wheel is over the edge or if the edge caves in.
- If machine stops while going uphill, disengage blades, shift into reverse and back down slowly.
- Do not turn on slopes unless necessary, and then, turn slowly and gradually downhill, if possible.



### III. SLOPE OPERATION

**WARNING!** When loading or unloading this machine, do not exceed the maximum recommended operation angle of 15°.

Slopes are a major factor related to loss of control and tip-over accidents, which can result in severe injury or death. Operation on all slopes requires extreme caution. If you cannot back up the slope or if you feel uneasy on it, do not mow it.

- Mow up and down slopes, not across.

### IV. TOWING

- Tow only with a machine that has a hitch designed for towing. Do not attach towed equipment except at the hitch point.
- Follow the manufacturer's recommendation for weight limits for towed equipment and towing on slopes.
- Never allow children or others in or on towed equipment.
- On slopes, the weight of the towed equipment may cause loss of traction and loss of control.
- Travel slowly and allow extra distance to stop.

## TROUBLESHOOTING CHART:

See appropriate section in manual unless directed to Sears service center.

PROBLEM	CAUSE	CORRECTION
<b>Poor cut - uneven cutting</b>	1 Worn, bent or loose blade.	1 Replace blade. Tighten blade bolt.
	2 Mower deck not level.	2 Level mower deck.
	3 Buildup of grass, leaves, and trash under mower.	3 Clean underside of mower housing.
	4 Bent blade mandrel.	4 Contact a Sears or other qualified service center.
	5 Clogged mower deck vent from build-up of grass, leaves, and trash around mandrels.	5 Clean around mandrels to open vent holes.
<b>Mower blades will not rotate</b>	1 Obstruction in clutch mechanism.	1 Remove obstruction.
	2 Worn/damaged mower drive belt.	2 Replace mower drive belt.
	3 Frozen idler pulley.	3 Replace idler pulley.
	4 Frozen blade mandrel.	4 Contact a Sears or other qualified service center.
<b>Poor grass discharge</b>	1 Engine speed too slow.	1 Place throttle control in "FAST" position.
	2 Travel speed too fast.	2 Shift to slower speed.
	3 Wet grass.	3 Allow grass to dry before mowing.
	4 Mower deck not level.	4 Level mower deck.
	5 Low/uneven tire air pressure.	5 Check tires for proper PSI.
	6 Worn, bent or loose blade.	6 Replace/sharpen blade. Tighten blade bolt.
	7 Buildup of grass, leaves and trash under mower.	7 Clean underside of mower housing.
	8 Mower drive belt worn.	8 Replace mower drive belt.
	9 Blades improperly installed.	9 Reinstall blades sharp edge down.
	10 Improper blades used.	10 Replace with blades listed in this manual.
	11 Clogged mower deck vent holes from buildup of grass, leaves, and trash around mandrels.	11 Clean around mandrels to open vent holes.
<b>Headlight(s) not working (if so equipped)</b>	1 Light switch is "OFF".	1 Turn light switch "ON".
	2 Bulb(s) or lamp(s) burned out.	2 Replace bulb(s) or lamp(s).
	3 Faulty light switch.	3 Check/replace light switch.
	4 Loose or damaged wiring.	4 Check wiring and connections.
	5 Blown fuse.	5 Replace fuse.

## TROUBLESHOOTING CHART:

See appropriate section in manual unless directed to Sears service center.

PROBLEM	CAUSE	CORRECTION
<b>Engine clicks but will not start</b>	1 Weak or dead battery.	1 Recharge or replace battery.
	2 Corroded battery terminals.	2 Clean battery terminals.
	3 Loose or damaged wiring.	3 Check all wiring.
	4 Faulty solenoid or starter.	4 Check/replace solenoid or starter.
<b>Loss of power</b>	1 Cutting too much grass/too fast.	1 Raise cutting height/reduce speed.
	2 Throttle in "CHOKE" position.	2 Adjust throttle control.
	3 Build-up of grass, leaves and trash under mower.	3 Clean underside of mower housing.
	4 Dirty air filter.	4 Clean/replace air filter.
	5 Low oil level/dirty oil.	5 Check oil level/change oil.
	6 Faulty spark plug.	6 Clean & regap or change spark plug.
	7 Dirty fuel filter.	7 Replace fuel filter.
	8 Stale or dirty fuel.	8 Empty fuel tank and refill tank with fresh, clean gasoline.
	9 Water in fuel.	9 Empty fuel tank and carburetor, refill tank with fresh gasoline and replace fuel filter.
	10 Spark plug wire loose.	10 Connect & tighten spark plug wire.
	11 Dirty engine air screen/fins.	11 Clean engine air screen/fins.
	12 Dirty/clogged muffler.	12 Clean/replace muffler.
	13 Loose or damaged wiring.	13 Check all wiring.
	14 Engine valves out of adjustment.	14 Contact a Sears or other qualified service center.
<b>Excessive vibration</b>	1 Worn, bent or loose blade.	1 Replace blade. Tighten blade bolt.
	2 Bent blade mandrel.	2 Contact a Sears or other qualified service center.
	3 Loose/damaged part(s).	3 Tighten loose part(s). Replace damaged parts.
<b>Engine continues to run when operator leaves seat with attachment clutch engaged</b>	1 Faulty operator-safety presence control system.	1 Check wiring, switches and connections. If not corrected, contact a Sears or other qualified service center.   <b>CAUTION: DO NOT operate machine until problem is corrected.</b>

## SAFETY RULES

### V. SERVICE

#### SAFE HANDLING OF GASOLINE

To avoid personal injury or property damage, use extreme care in handling gasoline. Gasoline is extremely flammable and the vapors are explosive.

- Extinguish all cigarettes, cigars, pipes, and other sources of ignition.
- Use only approved gasoline container.
- Never remove gas cap or add fuel with the engine running.
- Allow engine to cool before refueling.
- Never fuel the machine indoors.
- Never store the machine or fuel container where there is an open flame, spark, or pilot light such as on a water heater or other appliances.
- Never fill containers inside a vehicle or on a truck or trailer bed with plastic liner. Always place containers on the ground away from your vehicle when filling.
- Remove gas-powered equipment from the truck or trailer and refuel it on the ground. If this is not possible, then refuel such equipment with a portable container, rather than from a gasoline dispenser nozzle.
- Keep the nozzle in contact with the rim of the fuel tank or container opening at all times until fueling is complete. Do not use a nozzle lock-open device.
- If fuel is spilled on clothing, change clothing immediately.
- Never overfill fuel tank. Replace gas cap and tighten securely.

### GENERAL SERVICE

- Never operate machine in a closed area.
- Keep all nuts and bolts tight to ensure the equipment is in safe working condition.
- Never tamper with safety devices. Never interfere with the intended function of a safety device or reduce the protection provided by a safety device. Check there proper operation regularly. NEVER operate a machine with a safety device that does not function properly.
- Keep machine free of grass, leaves, or other debris build-up. Clean oil or fuel spillage and remove any fuel-soaked debris. Allow machine to cool before storing.
- If you strike a foreign object, stop and inspect the machine. Repair, if necessary, before restarting.
- Never make any adjustments or repairs with the engine running.
- Check grass catcher components and the discharge chute frequently and replace with manufacturer's recommended parts, when necessary.
- Mower blades are sharp. Wrap the blade or wear gloves, and use extreme caution when servicing them.
- Check brake operation frequently. Adjust and service as required.
- Maintain or replace safety and instruction labels, as necessary.



Use ear protectors to avoid damage to hearing.



Always wear eye protection when operating machine.



## PRODUCT SPECIFICATIONS

Gasoline Capacity and type:	1.50 Gallons/5,67 L Regular Unleaded†
Power Rating*:	13.0 kW @ 3400 RPM
Oil Type: (API: SG-SL)	SAE 30 (above 32°F/0°C) SAE 5W30 (below 32°F/0°C)
Oil Capacity:	48 Oz./1,4 L
Spark Plug:	Champion XC12YC (Gap: 0.30" / 0,76 mm)
Charging System:	3 Amps Battery 5 Amps Headlights
Battery:	Amp/Hr: 28 Min. CCA: 230 Case size: U1R
Blade Bolt Torque:	45-55 Ft. Lbs./62-75 Nm

\* The power rating as declared by the engine manufacturer is the average gross power output at the specified RPM of a typical production engine for the engine model measured using SAE Standards for engine gross power. Please refer to the engine manufacturer for details.

† ⚠ Gasoline containing up to 10% ethanol (E10) is acceptable for use in this machine. The use of any gasoline exceeding 10% ethanol (E10) will void the product warranty.

**CONGRATULATIONS** on your purchase of a new tractor. It has been designed, engineered and manufactured to give you the best possible dependability and performance. Should you experience any problem you cannot easily remedy, please contact a Sears or other qualified service center. We have competent, well-trained representatives and the proper tools to service or repair this tractor. Please read and retain this manual. The instructions will enable you to assemble and maintain your tractor properly. Always observe the "SAFETY RULES".

## CUSTOMER RESPONSIBILITIES

- Read and observe the safety rules.
- Follow a regular schedule in maintaining, caring for and using your tractor.
- Follow instructions under "Maintenance" and "Storage" sections of this manual.
- Wear proper Personal Protective Equipment (PPE) while operating this machine, including (at a minimum) sturdy footwear, eye protection, and hearing protection. Do not mow in shorts and/or open toed footwear.
- Always let someone know you are outside mowing.

**⚠ WARNING:** This tractor is equipped with an internal combustion engine and should not be used on or near any unimproved forest-covered, brush-covered or grass-covered land unless the engine's exhaust system is equipped with a spark arrester meeting applicable local or state laws (if any). If a spark arrester is used, it should be maintained in effective working order by the operator.

In the state of California the above is required by law (Section 4442 of the California Public Resources Code). Other states may have similar laws. Federal laws apply on federal lands. A spark arrester for the muffler is available through your nearest Sears service center (See REPAIR PARTS manual).

## TROUBLESHOOTING CHART:

See appropriate section in manual unless directed to Sears service center.

PROBLEM	CAUSE	CORRECTION
<b>Will not start</b>	1 Out of fuel.	1 Fill fuel tank.
	2 Engine not "CHOKED" properly.	2 See "TO START ENGINE" in Operation section.
	3 Engine flooded.	3 Wait several minutes before attempting to start.
	4 Bad spark plug.	4 Replace spark plug.
	5 Dirty air filter.	5 Clean/replace air filter.
	6 Dirty fuel filter.	6 Replace fuel filter.
	7 Water in fuel.	7 Empty fuel tank and carburetor, refill tank with fresh gasoline and replace fuel filter.
	8 Loose or damaged wiring.	8 Check all wiring.
	9 Engine valves out of adjustment.	9 Contact a Sears or other qualified service center.
<b>Hard to start</b>	1 Dirty air filter.	1 Clean/replace air filter.
	2 Bad spark plug.	2 Replace spark plug.
	3 Weak or dead battery.	3 Recharge or replace battery.
	4 Dirty fuel filter.	4 Replace fuel filter.
	5 Stale or dirty fuel.	5 Empty fuel tank and refill tank with fresh, clean gasoline.
	6 Loose or damaged wiring.	6 Check all wiring.
	7 Engine valves out of adjustment.	7 Contact a Sears or other qualified service center.
<b>Engine will not turn over</b>	1 Clutch/brake pedal not depressed.	1 Depress clutch/brake pedal.
	2 Attachment clutch is engaged.	2 Disengage attachment clutch.
	3 Weak or dead battery.	3 Recharge or replace battery.
	4 Blown fuse.	4 Replace fuse.
	5 Corroded battery terminals.	5 Clean battery terminals.
	6 Loose or damaged wiring.	6 Check all wiring.
	7 Faulty ignition switch.	7 Check/replace ignition switch.
	8 Faulty solenoid or starter.	8 Check/replace solenoid or starter.
	9 Faulty operator presence switch(es).	9 Contact a Sears or other qualified service center.

## STORAGE

Immediately prepare your tractor for storage at the end of the season or if the tractor will not be used for 30 days or more.

**⚠️ WARNING:** Never store the tractor with gasoline in the tank inside a building where fumes may reach an open flame or spark. Allow the engine to cool before storing in any enclosure.

### TRACTOR

Remove mower from tractor for winter storage. When mower is to be stored for a period of time, clean it thoroughly, remove all dirt, grease, leaves, etc. Store in a clean, dry area.

1. Clean entire tractor (See "CLEANING" in the Maintenance section of this manual).
2. Inspect and replace belts, if necessary (See belt replacement instructions in the Service and Adjustments section of this manual).
3. Lubricate as shown in the Maintenance section of this manual.
4. Ensure that all nuts, bolts and screws are securely fastened. Inspect moving parts for damage, breakage and wear. Replace if necessary.
5. Touch up all rusted or chipped paint surfaces; sand lightly before painting.

### BATTERY

- Fully charge the battery for storage.
- After a period of time in storage, battery may require recharging.
- To help prevent corrosion and power leakage during long periods of storage, battery cables should be disconnected and battery cleaned thoroughly (see "TO CLEAN BATTERY AND TERMINALS" in the Maintenance section of this manual).
- After cleaning, leave cables disconnected and place cables where they cannot come in contact with battery terminals.
- If battery is removed from tractor for storage, do not store battery directly on concrete or damp surfaces.
- If unit is equipped with battery indicator/charging plug, an optional charging unit may be purchased and connected to the unit to charge the battery during long term storage. Inspect and clean the battery terminals as needed prior to long term storage with charger connected.

### ENGINE

#### FUEL SYSTEM

**IMPORTANT:** It is important to prevent gum deposits from forming in essential fuel system parts such as carburetor, fuel hose, or tank during storage. Also, alcohol blended fuels (called gasohol or using ethanol or methanol) can attract moisture which leads to separation and formation of acids during storage. Acidic gas can damage the fuel system of an engine while in storage.

- Empty the fuel tank by starting the engine and letting it run until the fuel lines and carburetor are empty.
- Never use engine or carburetor cleaner products in the fuel tank or permanent damage may occur.
- Use fresh fuel next season.

**NOTE:** Fuel stabilizer is an acceptable alternative in minimizing the formation of fuel gum deposits during storage. Add stabilizer to gasoline in fuel tank or storage container. Always follow the mix ratio found on stabilizer container. Run engine at least 10 minutes after adding stabilizer to allow the stabilizer to reach the carburetor. Do not empty the gas tank and carburetor if using fuel stabilizer.

#### ENGINE OIL

Drain oil (with engine warm) and replace with clean engine oil. (See "ENGINE" in the Maintenance section of this manual).

#### CYLINDER(S)

1. Remove spark plug(s).
2. Pour one ounce (29.5 mL) of oil through spark plug hole(s) into cylinder(s).
3. Turn ignition key to "START" position for a few seconds to distribute oil.
4. Replace with new spark plug(s).

### OTHER

- Do not store gasoline from one season to another.
- Replace your gasoline can if your can starts to rust. Rust and/or dirt in your gasoline will cause problems.
- If possible, store your tractor indoors and cover it to give protection from dust and dirt.
- Cover your tractor with a suitable protective cover that does not retain moisture. Do not use plastic. Plastic cannot breathe which allows condensation to form and will cause your tractor to rust.

**IMPORTANT:** Never cover tractor while engine and exhaust areas are still warm.

## UNASSEMBLED PARTS

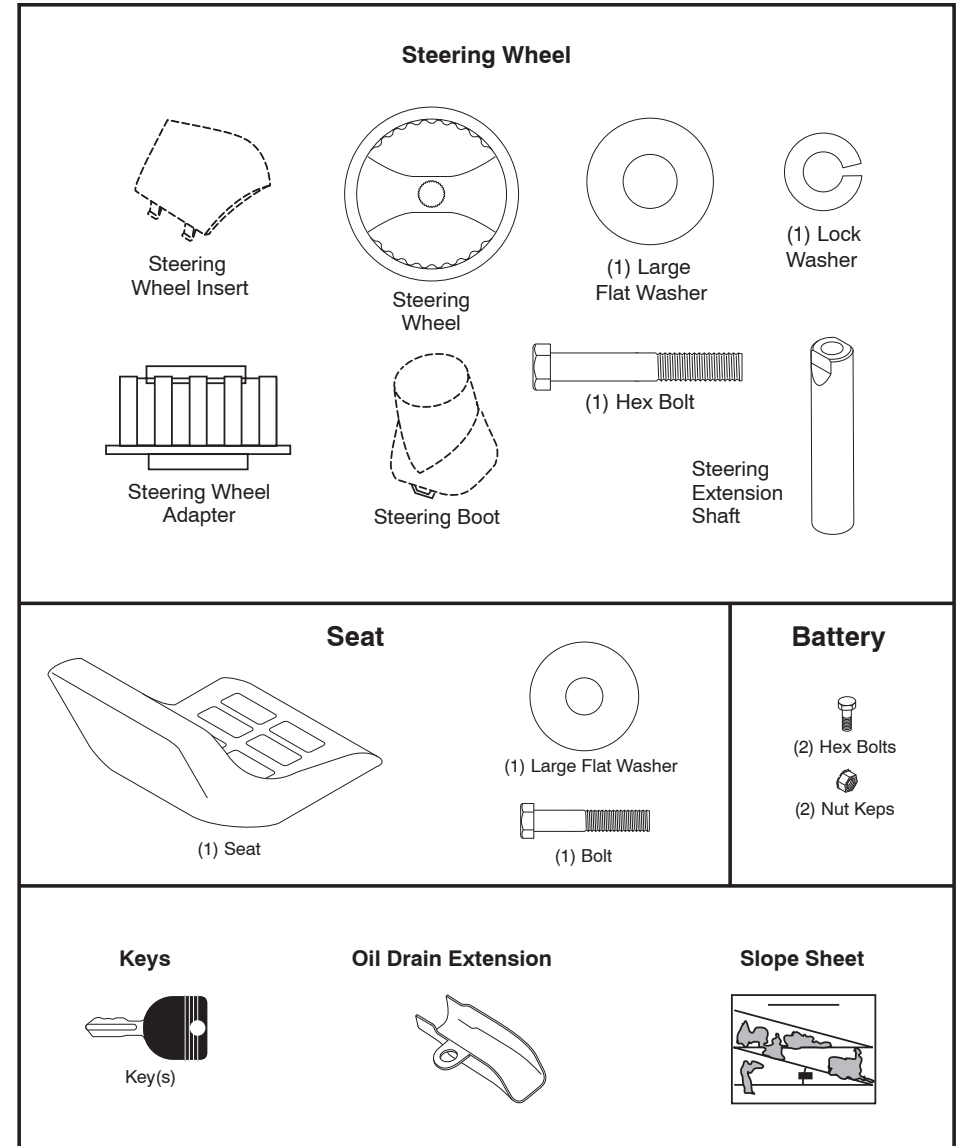

## ASSEMBLY/PRE-OPERATION

Your new tractor has been assembled at the factory with exception of those parts left unassembled for shipping purposes. To ensure safe and proper operation of your tractor all parts and hardware you assemble must be tightened securely. Use the correct tools as necessary to ensure proper tightness.

### TOOLS REQUIRED FOR ASSEMBLY

A socket wrench set will make assembly easier. Standard wrench sizes are listed.

- (1) 5/16" wrench     Utility knife
- (2) 7/16" wrenches     Tire pressure gauge
- (2) 1/2" wrenches     Pliers
- (1) 9/16" wrench

When right or left hand is mentioned in this manual, it means when you are in the operating position (seated behind the steering wheel).

### TO REMOVE TRACTOR FROM CARTON

#### UNPACK CARTON

- Remove all accessible loose parts and parts cartons from carton.
- Cut along dotted lines on all four panels of carton. Remove end panels and lay side panels flat.
- Check for any additional loose parts or cartons and remove.

### BEFORE REMOVING TRACTOR FROM SKID

#### TO CHECK BATTERY

1. Lift seat to raised position.

**NOTE:** If this battery is put into service after month and year indicated on label (label is located between terminals) charge battery for minimum of one hour at 6-10 amps. (See "BATTERY" in Maintenance section of this manual for charging instructions).

- For battery and battery cable installation see "REPLACING BATTERY" in the "Service and Adjustments" section in this manual.

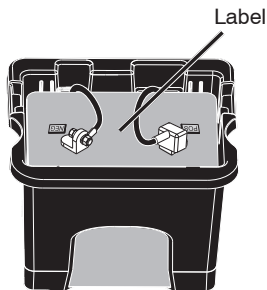

### TO INSTALL STEERING WHEEL

#### ASSEMBLE EXTENSION SHAFT AND BOOT

1. Slide extension shaft onto lower steering shaft.
2. Place tabs of steering boot over tab slots in dash and push down to secure.

#### INSTALL STEERING WHEEL

3. Position front wheels of the tractor so they are pointing straight forward.
4. Remove steering wheel adapter from steering wheel and slide adapter onto steering shaft extension.
5. Position steering wheel so cross bars are horizontal (left to right) and slide inside boot and onto adapter.
6. Assemble large flat washer, lock washer, bolt and tighten securely.
7. Snap steering wheel insert into center of steering wheel.
8. Remove protective materials from tractor hood and grill.

**IMPORTANT:** Check for and remove any staples in skid that may puncture tires where tractor is to roll off skid.

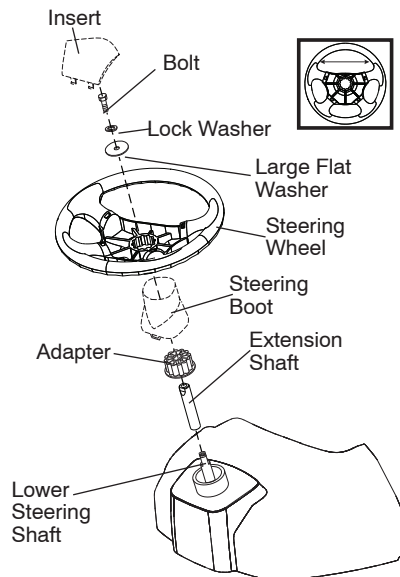

### TO REPLACE HEADLIGHT BULB

1. Raise hood.
2. Remove bulb holder from the hole in the backside of the grill.
3. Replace bulb in holder and install bulb holder securely back into the hole in the backside of the grill.
4. Close hood.

### INTERLOCKS AND RELAYS

Loose or damaged wiring may cause your tractor to run poorly, stop running, or prevent it from starting.

- Check wiring.

### TO REPLACE FUSE

Replace with 30 amp automotive-type plug-in fuse. The fuse holder is located behind the dash.

### TO REMOVE HOOD AND GRILL ASSEMBLY

1. Raise hood.
2. Unsnap headlight wire connector.
3. Stand in front of tractor. Grasp hood at sides, tilt toward engine and lift off of tractor.
4. When replacing hood, be sure to reconnect the headlight wire connector.

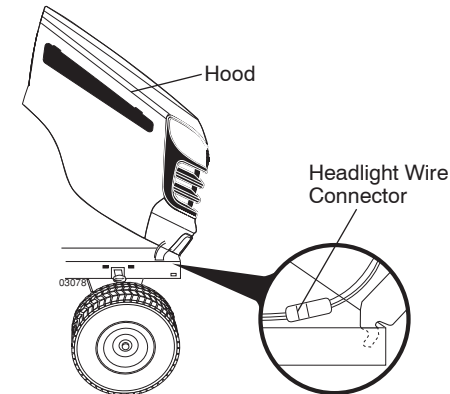

### TRANSMISSION REMOVAL/REPLACEMENT

Should your transmission require removal for service or replacement, it should be purged after reinstallation and before operating the tractor. See "PURGE TRANSMISSION" in the Operation section of this manual.

### ENGINE

#### TO ADJUST THROTTLE CONTROL CABLE

The throttle control has been preset at the factory and adjustment should not be necessary. Check adjustment as described below before loosening cable. If adjustment is necessary, see engine manual.

#### TO ADJUST CHOKE CONTROL

The choke control has been preset at the factory and adjustment should not be necessary. If adjustment is necessary, see engine manual.



## TO START ENGINE WITH A WEAK BATTERY

**WARNING:** Lead-acid batteries generate explosive gases. Keep sparks, flame and smoking materials away from batteries. Always wear eye protection when around batteries.

If your battery is too weak to start the engine, it should be recharged. (See "BATTERY" in the MAINTENANCE section of this manual). If "jumper cables" are used for emergency starting, follow this procedure:

**IMPORTANT:** Your tractor is equipped with a 12 volt system. The other vehicle must also be a 12 volt system. Do not use your tractor battery to start other vehicles.

### TO ATTACH JUMPER CABLES -

1. Connect one end of the RED cable to the POSITIVE (+) terminal of each battery (A-B), taking care not to short against tractor chassis.
2. Connect one end of the BLACK cable to the NEGATIVE (-) terminal (C) of fully charged battery.
3. Connect the other end of the BLACK cable (D) to good chassis ground, away from fuel tank and battery.

### TO REMOVE CABLES, REVERSE ORDER -

1. BLACK cable first from chassis and then from the fully charged battery.
2. RED cable last from both batteries.

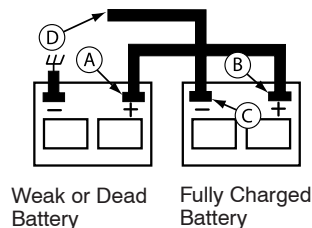

## REPLACING BATTERY

**WARNING:** Do not short battery terminals by allowing a wrench or any other object to contact both terminals at the same time. Before connecting battery, remove metal bracelets, wristwatch bands, rings, etc. Positive terminal must be connected first to prevent sparking from accidental grounding.

1. Lift seat pan to raised position.
2. Remove terminal cover.
3. Disconnect BLACK battery cable then RED battery cable and carefully remove battery from tractor.
4. Install new battery with terminals in same position as old battery.
5. Reinstall terminal cover.
6. First connect RED battery cable to positive (+) battery terminal with bolt and nut as shown. Tighten securely.
7. Connect BLACK grounding cable to negative (-) battery terminal with remaining bolt and nut. Tighten securely
8. Lower seat pan.

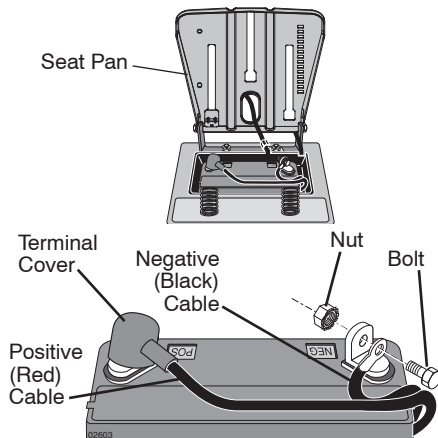

## INSTALL SEAT

1. Remove bolt and flat washer securing seat to cardboard packing and set aside for assembly of seat to tractor. Remove the cardboard packing and discard.
2. Connect switch to seat.
3. Place seat on seat pan so all three (3) bottom pads are positioned over large slotted holes in pan.

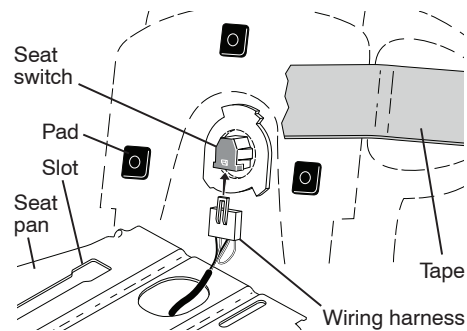

4. Push down on seat to engage pads in slots and pull seat towards rear of tractor.
5. Raise seat and tighten bolt securely.
6. Remove tape and discard.
7. Lower seat into operating position and sit on seat. Press clutch/brake pedal all the way down. If operating position is not comfortable, adjust seat.

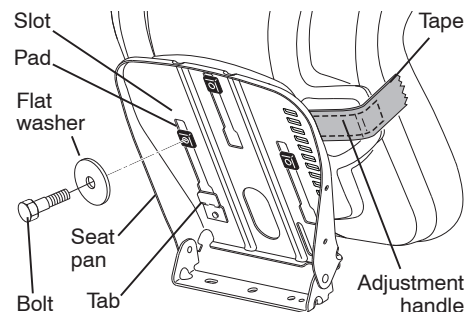

### TO ADJUST SEAT

Grasp adjustment handle and pull up, slide seat to desired position and release adjustment handle.

### INSTALL MULCHER PLATE (If Previously Removed)

1. Raise and hold deflector shield in upright position.
2. Place slot in mulcher plate over tab on mower and position plate over mower opening as shown.
3. Hook front latch into hole on front of mower.

4. Hook rear latch into hole on back of mower.

**CAUTION:** Do not remove deflector shield from mower.

### TO CONVERT TO BAGGING OR DISCHARGING

Simply remove mulcher plate and store in a safe place. Your mower is now ready for discharging or installation of optional grass catcher accessory.

**NOTE:** It is not necessary to change blades. The mulching blades are designed for discharging and bagging also.

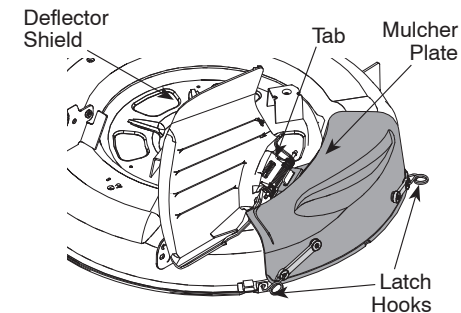

**NOTE:** You may now roll your tractor off the skid. Continue using the instructions that follow to remove the tractor from the skid.

**WARNING:** Before starting, read, understand and follow all instructions in the Operation section of this manual. Be sure tractor is in a well-ventilated area. Be sure the area in front of tractor is clear of other people and objects.

### TO ROLL TRACTOR OFF SKID (See Operation section for location and function of controls)

1. Raise attachment lift lever to its highest position.
2. Release parking brake by depressing clutch/brake pedal.
3. Place freewheel control in "transmission disengaged position" (See "TO TRANSPORT" in the Operation section of this manual).
4. Roll tractor forward off skid.
5. Remove banding holding the deflector shield up against tractor.

Continue with the instructions that follow.

## CHECK TIRE PRESSURE

The tires on your tractor were overinflated at the factory for shipping purposes. Correct tire pressure is important for best cutting performance.

- Reduce tire pressure to PSI shown on tires.

## CHECK DECK LEVELNESS

For best cutting results, mower housing should be properly leveled. See "TO LEVEL MOWER" in the Service and Adjustments section of this manual.

## CHECK FOR PROPER POSITION OF ALL BELTS

See the figures that are shown for replacing motion and mower blade drive belts in the Service and Adjustments section of this manual. Verify that the belts are routed correctly.

## CHECK BRAKE SYSTEM

After you learn how to operate your tractor, check to see that the brake is operating properly. See "TO CHECK BRAKE" in the Service and Adjustments section of this manual.

## ✓ CHECKLIST

Before you operate your new tractor, we wish to assure that you receive the best performance and satisfaction from this Quality Product.

Please review the following checklist:

- ✓ All assembly instructions have been completed.
- ✓ No remaining loose parts in carton.
- ✓ Battery is properly prepared and charged.
- ✓ Seat is adjusted comfortably and tightened securely.
- ✓ All tires are properly inflated. (For shipping purposes, the tires were overinflated at the factory).
- ✓ Be sure mower deck is properly leveled side-to-side/front-to-rear for best cutting results. (Tires must be properly inflated for leveling).
- ✓ Check mower and drive belts. Be sure they are routed properly around pulleys and inside all belt keepers.
- ✓ Check wiring. See that all connections are still secure and wires are properly clamped.
- ✓ Before driving tractor, be sure freewheel control is in "transmission engaged" position (see "To Transport" in the Operation section of this manual).

While learning how to use your tractor, pay extra attention to the following important items:

- ✓ Engine oil is at proper level.
- ✓ Fuel tank is filled with fresh, clean, regular unleaded gasoline.
- ✓ Become familiar with all controls, their location and function. Operate them before you start the engine.
- ✓ Be sure brake system is in safe operating condition.
- ✓ Be sure Operator Presence System and Reverse Operation System (ROS) are working properly (See the Operation and Maintenance sections in this manual).
- ✓ It is important to purge the transmission before operating your tractor for the first time. Follow proper starting and transmission purging instructions (See "TO START ENGINE" and "PURGE TRANSMISSION" in the Operation section of this manual).

## TRANSAXLE MOTION CONTROL LEVER NEUTRAL ADJUSTMENT

The motion control lever has been preset at the factory and adjustment should not be necessary.

1. Loosen adjustment bolt in front of the right rear wheel, and lightly tighten.
2. Start engine and move motion control lever until tractor does not move forward or backward.
3. Hold motion control lever in that position and turn engine off.
4. While holding motion control lever in place, loosen the adjustment bolt.
5. Move motion control lever to the neutral (N) (lock gate) position.
6. Tighten adjustment bolt securely.

**NOTE:** If additional clearance is needed to get to adjustment bolt, move mower deck height to the lowest position.

After above adjustment is made, if the tractor still creeps forward or backward while motion control lever is in neutral position, follow these steps:

1. Loosen the adjustment bolt.
2. Move the motion control lever 1/4 to 1/2 inch in the direction it is trying to creep.
3. Tighten adjustment bolt securely.
4. Start engine and test.
5. If tractor still creeps, repeat above steps until satisfied.

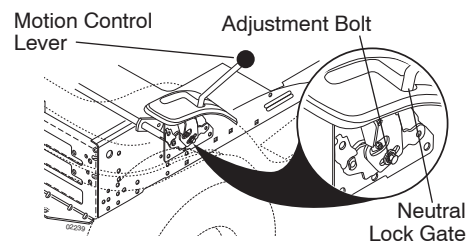

## TO CHECK BRAKE

If tractor requires more than five (5) feet (1,5 m) to stop at highest speed in highest gear on a level, dry concrete or paved surface, then brake must be serviced.

You may also check brake by:

1. Park tractor on a level, dry concrete or paved surface, depress brake pedal all the way down and engage parking brake.
2. Disengage transmission by placing freewheel control in "transmission disengaged" position. Pull freewheel control out and into the slot and release so it is held in the disengaged position.

The rear wheels must lock and skid when you try to manually push the tractor forward. If the rear wheels rotate, then the brake needs to be serviced. Contact a Sears or other qualified service center.

## FRONT WHEEL TOE-IN/CAMBER

Your new tractor front wheel toe-in and camber is set at the factory and is normal. The front wheel toe-in and camber are not adjustable. If damage has occurred to affect the factory set front wheel toe-in or camber, contact a Sears or other qualified service center.

## TO REMOVE WHEEL FOR REPAIRS

1. Block up axle securely.
2. Remove axle cover, retaining ring and washers to allow wheel removal (rear wheels have a square key - Do not lose).
3. Repair tire and reassemble.
4. Replace washers and snap retaining ring securely in axle groove.
5. Replace axle cover.

**NOTE:** To seal tire punctures and prevent flat tires due to slow leaks, purchase and use tire sealant from Sears. Tire sealant also prevents tire dry rot and corrosion.

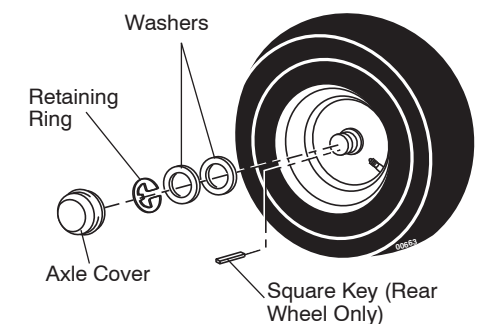

## TO REPLACE MOWER BLADE DRIVE BELT

The mower blade drive belt may be replaced without tools. Park the tractor on level surface. Engage parking brake.

### BELT REMOVAL -

1. Remove mower. (See "TO REMOVE MOWER" in this section of manual.)
2. Work belt off mandrel pulley and idler pulleys.
3. Pull belt away from mower.

### BELT INSTALLATION -

1. Work belt around mandrel pulley and idler pulleys
2. Ensure belt is in all pulley grooves and inside all belt guides.
3. Install mower (See "To Install Mower" in this section of this manual).

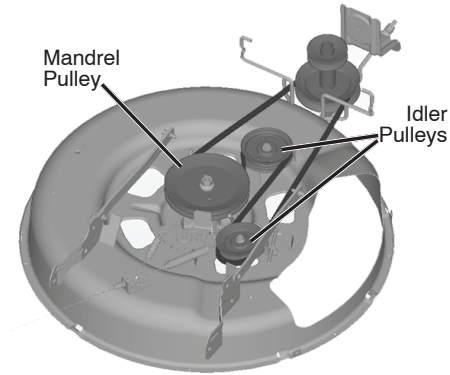

## TO REPLACE MOTION DRIVE BELT

Park the tractor on level surface. Engage parking brake. For assistance, there is a belt installation guide decal on bottom side of left footrest.

### BELT REMOVAL -

1. Remove mower (See "TO REMOVE MOWER" in this section of manual).

**NOTE:** Observe entire motion drive belt and position of all belt guides and keepers.

2. Remove belt from stationary idler (A) and clutching idler (B).
3. Remove belt from centerspan idler (C).
6. Pull belt slack toward rear of tractor. Carefully remove belt upwards from transmission input pulley and over cooling fan blades (D).
4. Remove belt downward from engine pulley (E).
5. Slide belt toward rear of tractor, off the steering plate (F) and remove from tractor.





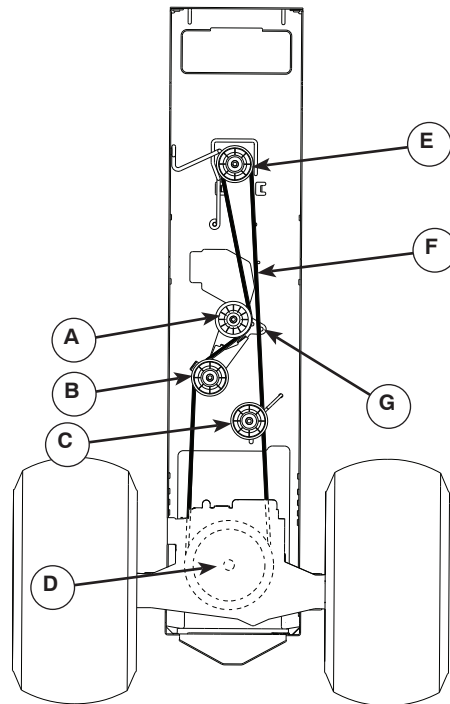























## BELT INSTALLATION -

1. Install new belt from tractor rear to front, over the steering plate (F) and above clutch brake pedal shaft (G).
2. Pull belt toward front of tractor and roll belt onto engine pulley (E).
3. Pull belt toward rear of tractor. Carefully work belt down around transmission cooling fan and onto the input pulley (D). Be sure belt is inside the belt keeper.
4. Install belt on centerspan idler (C).
5. Install belt through stationary idler (A) and clutching idler (B).
6. Ensure the belt is in all pulley grooves and inside all belt guides and keepers.
7. Install mower (See "TO INSTALL MOWER" in this section of manual).



## OPERATION

These symbols may appear on your tractor or in literature supplied with the product. Learn and understand their meaning.

 REVERSE	 NEUTRAL	 HIGH	 LOW	 CHOKE	 FAST	 SLOW	 IGNITION SWITCH
 ENGINE OFF	 ENGINE START	 ENGINE ON	 DIFFERENTIAL LOCK	 CLUTCH/ BRAKE PEDAL	 PARKING BRAKE	 MOWER HEIGHT	 MOWER LIFT
 REVERSE OPERATION SYSTEM (ROS)	 REVERSE	 FORWARD	 CRUISE CONTROL	 LIGHTS ON	 FUEL	 BATTERY	 EAR PROTECTION RECOMMENDED
 ATTACHMENT CLUTCH DISENGAGED	 ATTACHMENT CLUTCH ENGAGED	 DANGER, KEEP HANDS AND FEET AWAY	 KEEP AREA CLEAR (SEE SAFETY RULES SECTION)		 SLOPE HAZARDS (SEE SAFETY RULES SECTION)		
 FREE WHEEL (Automatic Models only)							
		Failure to follow instructions could result in serious injury or death. The safety alert symbol is used to identify safety information about hazards which can result in death, serious injury and/or property damage.					
		<b>HOT SURFACES</b> indicates a hazard which, if not avoided, could result in death, serious injury and/or property damage.					
		<b>FIRE</b> indicates a hazard which, if not avoided, could result in death, serious injury and/or property damage.					



## KNOW YOUR TRACTOR

### READ THIS MANUAL AND SAFETY RULES BEFORE OPERATING YOUR TRACTOR

Compare the illustrations with your tractor to familiarize yourself with the locations of various controls and adjustments. Save this manual for future reference.

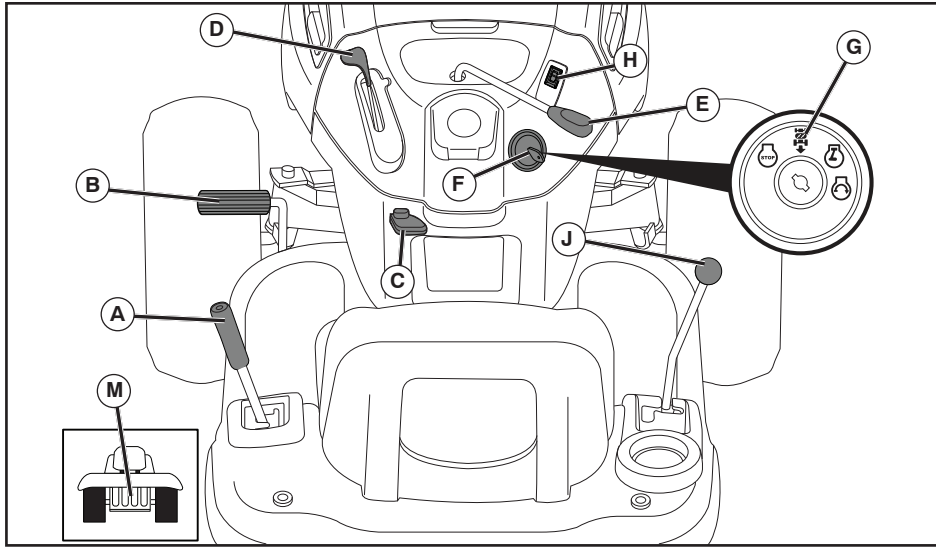

Our tractors conform to the applicable safety standards of the American National Standards Institute.

**(A) ATTACHMENT LIFT LEVER** - Used to raise and lower the mower or other attachments mounted to your tractor.

**(B) BRAKE PEDAL** - Used for braking the tractor and starting the engine.

**(C) PARKING BRAKE** - Locks clutch/brake pedal into the brake position.

**(D) THROTTLE/CHOKE CONTROL** - Used for starting and controlling engine speed.

**(E) ATTACHMENT CLUTCH LEVER** - Used to engage the mower blades, or other attachments mounted to your tractor.

**(F) IGNITION SWITCH** - Used for starting and stopping the engine.

**(G) REVERSE OPERATION SYSTEM (ROS) "ON" POSITION** - Allows operation of mower or other powered attachment while in reverse.

**(H) LIGHT SWITCH** - Turns the headlights on and off.

**(J) MOTION CONTROL LEVER** - Selects the speed and direction of the tractor.

**(M) FREEWHEEL CONTROL** - Disengages transmission for pushing or slowly towing the tractor with the engine off.

## TO LEVEL MOWER

Ensure tires are properly inflated to the PSI shown on tires. If tires are over or under inflated, it may affect the appearance of your lawn and lead you to think the mower is not adjusted properly.

### VISUAL SIDE-TO-SIDE ADJUSTMENT

1. With all tires properly inflated and if your lawn appears unevenly cut, determine which side of mower is cutting lower.
2. With a 3/4" or adjustable wrench, turn lift link adjustment nut (A) to the left to lower LH side of mower, or, to the right to raise LH side of mower.

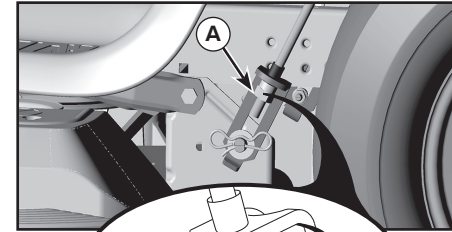

Turn nut right to raise mower

Turn nut left to lower mower

**NOTE:** Each full turn of adjustment nut will change mower height about 3/16" (4,7 mm).

3. Test your adjustment by mowing some uncut grass and visually checking the appearance. Readjust, if necessary, until you are satisfied with the results.

### PRECISION SIDE-TO-SIDE ADJUSTMENT

1. With all tires properly inflated, park tractor on level ground or driveway.

**CAUTION:** Blades are sharp. Protect your hands with gloves and/or wrap blade with heavy cloth.

2. Raise mower to its highest position.
3. At both sides of mower, position blade at side and measure distance "A" from bottom edge of blade to ground. The distance should be the same on both sides.
4. If adjustment is necessary, see steps in Visual Adjustment instructions above.
5. Recheck measurements; adjust if necessary until both sides are equal.

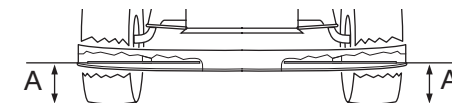

## FRONT-TO-BACK ADJUSTMENT

**IMPORTANT:** Deck must be level side-to-side.

To obtain the best cutting results, the mower blades should be adjusted so the front tip is 1/8 to 1/2" (3,1 to 12,7 mm) (lower than the rear tip when the mower is in its highest position).

**CAUTION:** Blades are sharp. Protect your hands with gloves and/or wrap blade with heavy cloth.

- Raise mower to highest position.
- Position any blade so the tip is pointing straight forward. Measure distance "B" to the ground at front and rear tip of blade.

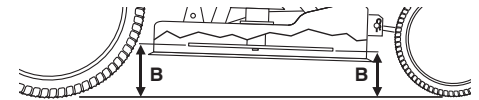

- If front tip of blade is not 1/8 to 1/2" (3,1 to 12,7 mm) lower than the rear tip, go to the front of tractor.

- With an 11/16" or adjustable wrench, loosen jam nut "A" several turns to clear adjustment nut "B".

- With a 3/4" or adjustable wrench, turn front link adjustment nut "B" clockwise (↻) (tighten) to raise the front of mower, or, counterclockwise (↺) (loosen) to lower the front mower.

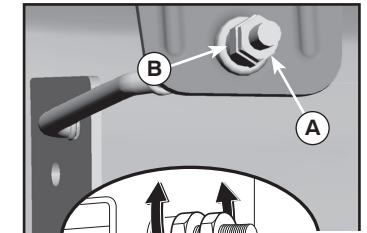

Tighten adjust nut "B" to raise mower

Loosen adjust nut "B" to lower mower

Loosen jam nut "A" first

**NOTE:** Each full turn of adjustment nut will change mower height about 1/8" (3,1 mm).

- Recheck measurements, adjust if necessary until front tip of blade is 1/8 to 1/2" (3,1 to 12,7 mm) lower than the rear tip.
- Hold adjustment nut in position with wrench and tighten jam nut securely against adjustment nut.

- ATTACH MOWER SIDE SUSPENSION ARMS (A) TO CHASSIS - Position hole in arm over pin (B) on outside of tractor chassis and secure with retainer spring.
- Repeat on opposite side of tractor.

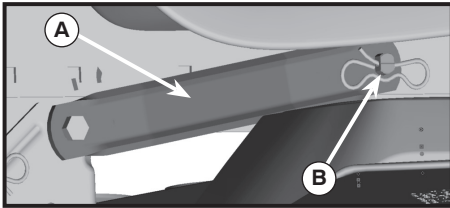

- ATTACH REAR LIFT LINKS (C) - Lift rear corner of mower and position slot in link assembly over pin (D) on rear mower bracket and secure with washer and retainer spring.

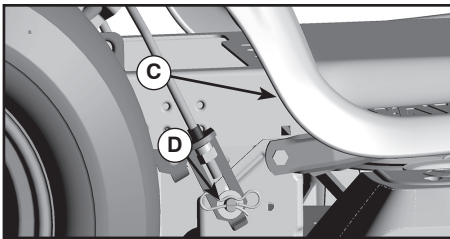

- ATTACH FRONT LINK (E) - Work from left side of tractor. Insert rod end of link assembly through front hole in tractor front suspension bracket (F).

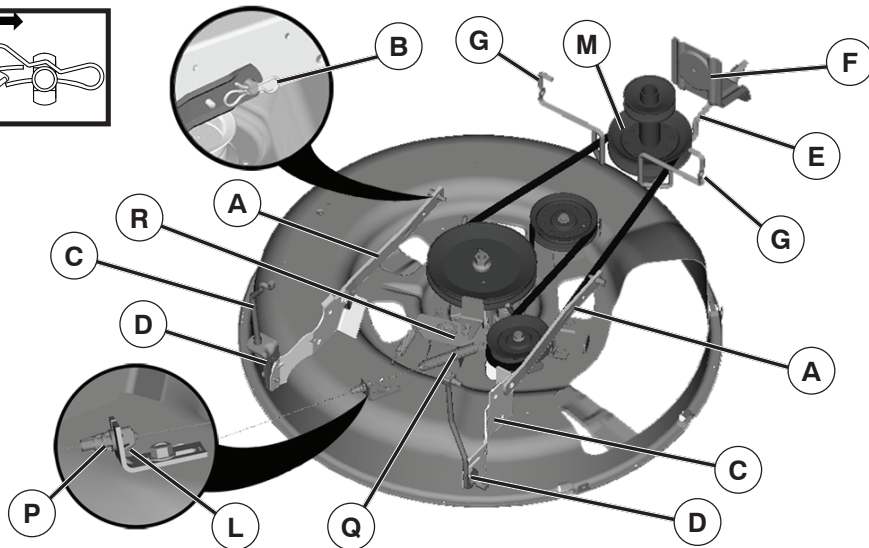
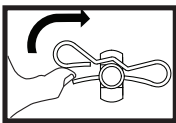

- Insert end of link (E) into hole in front mower bracket (F) and secure with washer and retainer spring (J).

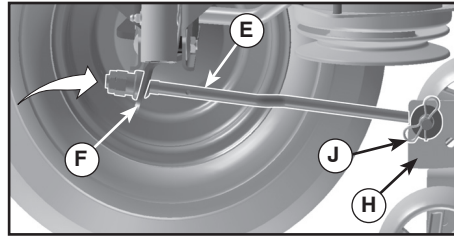

- Hook end of clutch cable spring (Q) into hole in idler arm (R).
- Push clutch cable housing guide (P) into bracket.
- Install belt onto engine pulley (M) and belt keepers (G).

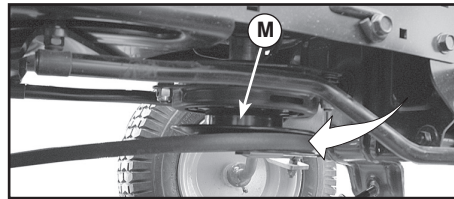

**IMPORTANT:** Check belt for proper routing in all mower pulley grooves.

- Raise attachment lift lever to highest position.
- If necessary, adjust gauge wheels before operating mower as shown in the Operation section of this manual.



The operation of any tractor can result in foreign objects thrown into the eyes, which can result in severe eye damage. Always wear safety glasses or eye shields while operating your tractor or performing any adjustments or repairs. We recommend standard safety glasses or a wide vision safety mask worn over spectacles.

### HOW TO USE YOUR TRACTOR TO SET PARKING BRAKE

Your tractor is equipped with an operator presence sensing switch. When engine is running, any attempt by the operator to leave the seat without first setting the parking brake will shut off the engine.

- Depress brake pedal (B) all the way down and hold.
- Pull parking brake lever (C) up and hold, release pressure from brake pedal (B), then release parking brake lever. Pedal should remain in brake position. Ensure parking brake will hold tractor secure.

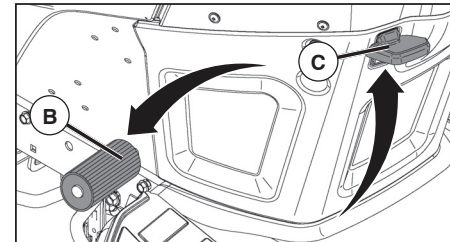

### STOPPING

#### MOWER BLADES -

- To stop mower blades, move attachment clutch control to disengaged position (☒).

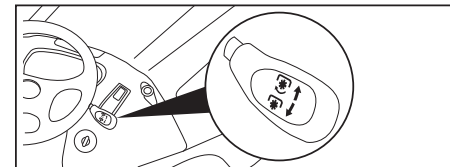

(☒) Attachment Clutch Control "Engaged"

(☒) Attachment Clutch Control "Disengaged"

#### GROUND DRIVE -

- To stop ground drive, depress brake pedal all the way down.
- Move motion control lever to neutral position.

#### ENGINE -

- Move throttle control (D) to fast position. **NOTE:** Failure to move throttle control to fast position before stopping may cause engine to "backfire".

- Turn ignition key (F) to "STOP" position and remove key. Always remove key when leaving tractor to prevent unauthorized use.
- Never use choke to stop engine.

**IMPORTANT:** Leaving the ignition switch in any position other than "STOP" will cause the battery to discharge and go dead.

**NOTE:** Under certain conditions when tractor is standing idle with the engine running, hot engine exhaust gases may cause "browning" of grass. To eliminate this possibility, always stop engine when stopping tractor on grass areas.

**CAUTION:** Always stop tractor completely, as described above, before leaving the operator's position.

#### TO USE THROTTLE CONTROL (D)

Always operate engine at full speed (fast).

- Operating engine at less than full speed (fast) reduces engine's operating efficiency.
- Full speed (fast) offers the best mower performance.

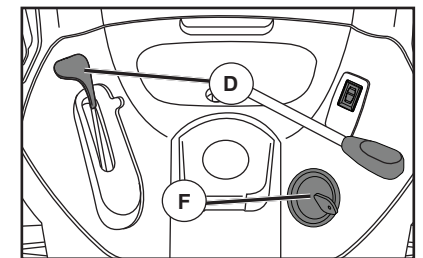



## TO MOVE FORWARD AND BACKWARD

The direction and speed of movement is controlled by the motion control lever. (J)

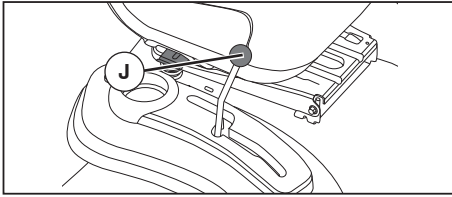

1. Start tractor with motion control lever in neutral (N) position.
2. Release parking brake.
3. Slowly move motion control lever to desired position.

## TO ADJUST MOWER CUTTING HEIGHT

The position of the attachment lift lever (A) determines the cutting height.

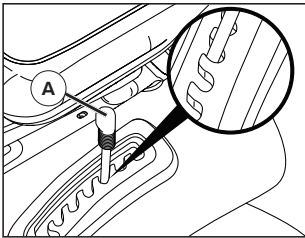

- Put attachment lift lever in desired cutting height slot.

The cutting height range is approximately 1 to 4" (25,4 to 101,6 mm). The heights are measured from the ground to the blade tip with the engine not running. These heights are approximate and may vary depending upon soil conditions, height of grass and types of grass being mowed.

- The average lawn should be cut to approximately 2-1/2" (63,5 mm) during the cool season and to over 3" (76,2 mm) during hot months. For healthier and better looking lawns, mow often and after moderate growth.
- For best cutting performance, grass over 6" (152,4 mm) in height should be mowed twice. Make the first cut relatively high; the second to desired height.

## TO ADJUST GAUGE WHEELS

Gauge wheels are properly adjusted when they are slightly off the ground when mower is at the desired cutting height in operating position. Gauge wheels then keep the deck in proper position to help prevent scalping in most terrain conditions.

**NOTE:** Adjust gauge wheels with tractor on a flat level surface.

1. Adjust mower to desired cutting height (See "TO ADJUST MOWER CUTTING HEIGHT" in this section of manual).
2. With mower in desired height of cut position, gauge wheels should be assembled so they are slightly off the ground. Install gauge wheel in appropriate hole. Tighten securely.
3. Repeat for all, installing gauge wheel in same adjustment hole.

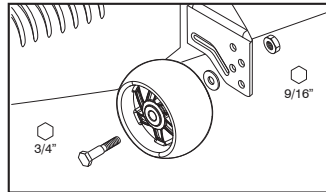

## TO OPERATE MOWER

Your tractor is equipped with an operator presence sensing switch. Any attempt by the operator to leave the seat with the engine running and the attachment clutch engaged will shut off the engine. You must remain fully and centrally positioned in the seat to prevent the engine from hesitating or cutting off when operating your equipment on rough, rolling terrain or hills.

1. Select desired height of cut with attachment lift lever.
2. Start mower blades by engaging attachment clutch control.

## TO STOP MOWER BLADES

Disengage attachment clutch control.

**CAUTION:** Do not operate the mower without either the entire grass catcher, on mowers so equipped, or the deflector shield in place.

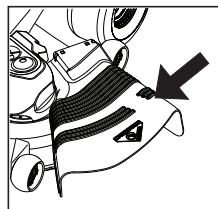

## SERVICE AND ADJUSTMENTS

### **WARNING: TO AVOID SERIOUS INJURY, BEFORE PERFORMING ANY SERVICE OR ADJUSTMENTS:**

1. Depress clutch/brake pedal fully and set parking brake.
2. Place motion control lever in neutral position.
3. Place attachment clutch in "DISENGAGED" position.
4. Turn ignition key to "STOP" and remove key.
5. Ensure the blades and all moving parts have completely stopped.
6. Disconnect spark plug wire from spark plug and place wire where it cannot come in contact with plug.

## TO REMOVE MOWER

1. Place attachment clutch in "DISENGAGED" position.
2. Lower attachment lift lever to its lowest position.
3. Roll belt off engine pulley (M) and belt keepers (G).
4. Remove cable (P) by depressing tab (L).
5. Remove clutch cable spring (Q) from idler arm (R).
6. Disconnect front link (E) from mower - remove retainer spring and washer.
7. Go to either side of mower and disconnect mower suspension arm (A) from chassis pin (B) and rear lift link (C) from rear mower bracket (D) - remove retainer springs and washers.

**CAUTION:** After rear lift links are disconnected, the attachment lift lever will be spring loaded. Have a tight grip on lift lever when changing position of the lever.

8. Slide mower out from under right side of tractor.

**IMPORTANT:** If an attachment other than the mower is to be mounted on the tractor, remove the front link (E) and rear lift links (C) from tractor and hook the clutch spring (Q) into the cable guide on front edge of lower dash.

## TO INSTALL MOWER

Ensure tractor is on level surface and engage parking brake.

1. Lower attachment lift to lowest position.

**CAUTION:** Lift lever is spring loaded. Have a tight grip on lift lever, lower it slowly and engage in lowest position.

**NOTE:** Ensure mower side suspension arms (A) are pointing forward before sliding mower under tractor.

2. Slide mower under tractor until it is centered under tractor.

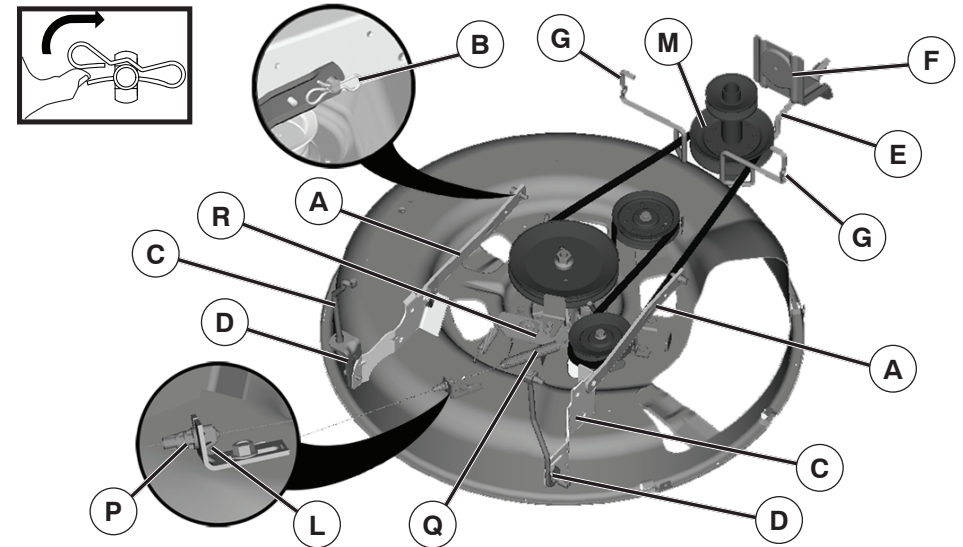

## CLEANING

- Clean engine, battery, seat, finish, etc. of all foreign matter.
- Clean debris from steering plate. Debris can restrict clutch/brake pedal shaft movement, causing belt slip and loss of drive.

**⚠ CAUTION:** Avoid all pinch points and movable parts

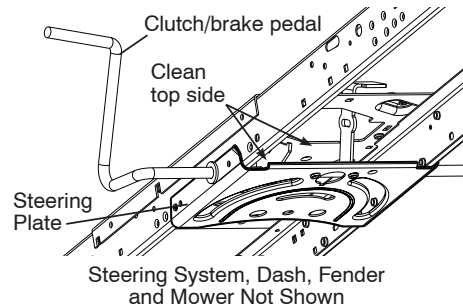

- Keep finished surfaces and wheels free of all gasoline, oil, etc.
- Protect painted surfaces with automotive type wax.

Except for the washout port (if equipped), we do not recommend using a garden hose or pressure washer to clean the outside of your tractor unless the engine and transmission are covered to keep water out. Water in engine or transmission will shorten the useful life of your tractor. Use compressed air or a leaf blower to remove grass, leaves and trash from outside tractor and mower.

## REVERSE OPERATION SYSTEM (ROS)

Your tractor is equipped with a Reverse Operation System (ROS). Any attempt by the operator to travel in the reverse direction with the attachment clutch engaged will shut off the engine unless ignition key is placed in the ROS "ON" position.

**⚠ WARNING:** Backing up with the attachment clutch engaged while mowing is strongly discouraged. Turning the ROS "ON", to allow reverse operation with the attachment clutch engaged, should only be done when the operator decides it is necessary to reposition the machine with the attachment engaged. **Do not mow in reverse unless absolutely necessary.**

### USING THE REVERSE OPERATION SYSTEM -

Only use if you are certain no children or other bystanders will enter the mowing area.

1. Move motion control lever to neutral (N) position.
2. With engine running, turn ignition key counterclockwise to ROS "ON" position.
3. Look down and behind before and while backing.
4. Slowly move motion control lever to reverse (R) position to start movement.
5. When use of the ROS is no longer needed, turn the ignition key clockwise to engine "ON" position.

ROS "ON" Position



Engine "ON" Position (Normal Operating)



## TO OPERATE ON HILLS

**⚠ WARNING:** Do not drive up or down hills with slopes greater than 15° and do not drive across any slope. Use the slope guide provided at the back of this manual.

- Choose the slowest speed before starting up or down hills.
- Avoid stopping or changing speed on hills.
- If stopping is absolutely necessary, push clutch/brake pedal quickly to brake position and engage parking brake.
- Move motion control lever to neutral position.

**IMPORTANT:** The motion control lever does not return to neutral position when the clutch/brake pedal is depressed.

- To restart movement, slowly release parking brake and clutch/brake pedal.
- Slowly move motion control lever to slowest setting.
- Make all turns slowly.

## TO TRANSPORT

When pushing or towing your tractor, be sure to disengage transmission by placing freewheel control in freewheeling position. Free wheel control is located at the rear drawbar of tractor.

- Raise attachment lift to highest position with attachment lift control.
- Pull freewheel control out and into the slot and release so it is held in the disengaged position.
- Do not push or tow tractor at more than two (2) mph (3,2 km/h).
- To reengage transmission, reverse above procedure.

Transmission Engaged

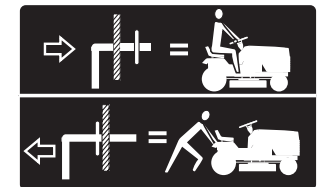

Transmission Disengaged

**NOTE:** To protect hood from damage when transporting your tractor on a truck or a trailer, be sure hood is closed and secured to tractor. Use an appropriate means of tying hood to tractor (rope, cord, etc.).

## TOWING CARTS AND OTHER ATTACHMENTS

Tow only the attachments that are recommended by and comply with specifications of the manufacturer of your tractor. Use common sense when towing. Too heavy of a load, while on a slope, is dangerous. Tires can lose traction with the ground and cause you to lose control of your tractor.

## BEFORE STARTING THE ENGINE

### CHECK ENGINE OIL LEVEL

The engine in your tractor has been shipped from the factory already filled with summer weight oil.

1. Check engine oil with tractor on level ground.
2. Remove oil fill cap/dipstick and wipe clean, reinsert the dipstick and screw cap tight, wait for a few seconds, remove and read oil level. If necessary, add oil until "FULL" mark on dipstick is reached. Do not overfill.
- For cold weather operation you should change oil for easier starting (See the oil viscosity chart in the Maintenance section of this manual).
- To change engine oil, see the Maintenance section in this manual.

### ADD GASOLINE

- Fill fuel tank to bottom of filler neck. Do not overfill. Use fresh, clean, regular gasoline with a minimum of 87 octane. Do not mix oil with gasoline. Purchase fuel in quantities that can be used within 30 days to ensure fuel freshness.

**CAUTION:** Wipe off any spilled oil or fuel. Do not store, spill or use gasoline near an open flame.

**IMPORTANT:** When operating in temperatures below 32°F (0°C), use fresh, clean winter grade gasoline to help ensure good cold weather starting.

**CAUTION:** Alcohol blended fuels (called gasohol or using ethanol or methanol) can attract moisture which leads to separation and formation of acids during storage. Acidic gas can damage the fuel system of an engine while in storage. To avoid engine problems, the fuel system should be emptied before storage of 30 days or longer. Drain the gas tank, start the engine and let it run until the fuel lines and carburetor are empty. Use fresh fuel next season. See Storage Instructions for additional information. Never use engine or carburetor cleaner products in the fuel tank or permanent damage may occur. Fuel stabilizer is an acceptable alternative in minimizing the formation of fuel gum deposits during storage. Add stabilizer to gasoline in fuel tank or storage container. Always follow the mix ratio found on stabilizer container. Run engine at least 10 minutes after adding stabilizer to allow the stabilizer to reach the carburetor. Do not empty the gas tank and carburetor if using fuel stabilizer.

## TO START ENGINE

When starting the engine for the first time or if the engine has run out of fuel, it will take extra cranking time to move fuel from the tank to the engine.

1. Ensure freewheel control is in the transmission engaged position.
2. Sit on seat in operating position, depress clutch/brake pedal and set parking brake.
3. Place motion control lever into neutral position.
4. Move attachment clutch to disengaged position.
5. Move throttle control to choke position.

**NOTE:** Before starting, read the warm and cold starting procedures below.

6. Insert key into ignition and turn key clockwise to start position and release key as soon as engine starts. Do not run starter continuously for more than fifteen seconds per minute. If the engine does not start after several attempts, move throttle control to fast position, wait a few minutes and try again. If engine still does not start, move the throttle control back to the choke position and retry.

### WARM WEATHER STARTING (50°F (10°C) and above)

7. When engine starts, move the throttle control to the fast position.
  - The attachments and ground drive can now be used. If the engine does not accept the load, restart the engine and allow it to warm up for one minute using the choke as described above.

### COLD WEATHER STARTING (50°F (10°C) and below)

7. When engine starts, leave throttle control in choke position until engine warms up and begins to run roughly. Once rough running begins, immediately move the throttle control to the fast position. Engine warm-up may take from several seconds to several minutes (the colder the temperature, the longer the warm-up).

**AUTOMATIC TRANSMISSION WARM UP**  
Before driving the unit in cold weather, the transmission should be warmed up as follows:

1. Ensure the tractor is on level ground.
2. Place the motion control lever in neutral. Release the parking brake and let the clutch/brake slowly return to operating position.

13. Refill engine with oil through oil fill dipstick tube. Pour slowly. Do not overfill. For approximate capacity see "PRODUCT SPECIFICATIONS" section of this manual.
14. Use gauge on oil fill cap/dipstick for checking level. Ensure dipstick cap is tightened securely for accurate reading. Keep oil at "FULL" line on dipstick. Tighten cap onto the tube securely when finished.

### AIR FILTER

Your engine will not run properly using a dirty air filter. Service paper cartridge every 100 hours of operation or every season, whichever occurs first.

Service air cleaner more often under dusty conditions.

1. Remove cover.
2. Carefully remove air filter cartridge from base.
3. Clean base carefully to prevent debris from falling into carburetor.

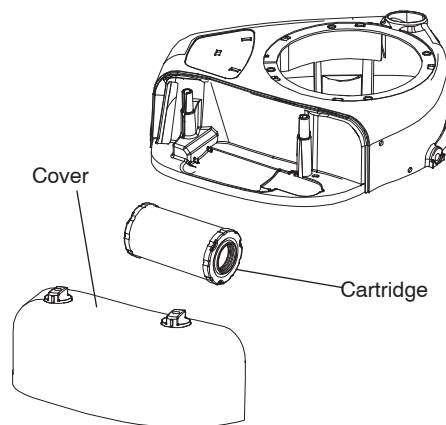

**NOTE:** If very dirty or damaged, replace cartridge.

4. Place new cartridge firmly in base.
5. Replace cover.

**IMPORTANT:** Petroleum solvents, such as kerosene, are not to be used to clean the cartridge. They may cause deterioration of the cartridge. Do not oil cartridge. Do not use pressurized air to clean cartridge.

### CLEAN AIR SCREEN

Air screen must be kept free of dirt and chaff to prevent engine damage from overheating. Clean with a wire brush or compressed air to remove dirt and stubborn dried gum fibers.

## ENGINE COOLING SYSTEM

Debris may clog the engine's air cooling system. Remove blower housing and clean the area shown to prevent overheating and engine damage.

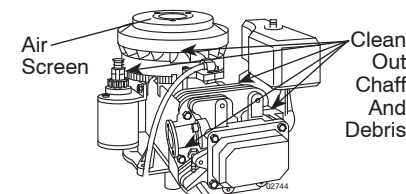

### MUFFLER

Inspect and replace corroded muffler and spark arrester (if equipped) as it could create a fire hazard and/or damage.

### SPARK PLUG(S)

Replace spark plug(s) at the beginning of each mowing season or after every 100 hours of operation, whichever occurs first. Spark plug type and gap setting are shown in "PRODUCT SPECIFICATIONS" section of this manual.

### IN-LINE FUEL FILTER

The fuel filter should be replaced once each season. If fuel filter becomes clogged, obstructing fuel flow to carburetor, replacement is required.

1. With engine cool, remove filter and plug fuel line sections.
2. Place new fuel filter in position in fuel line with arrow pointing towards carburetor.
3. Be sure there are no fuel line leaks and clamps are properly positioned.
4. Immediately wipe up any spilled gasoline.

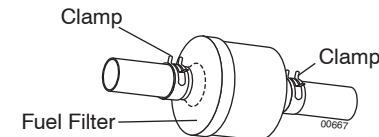



**TO CLEAN BATTERY AND TERMINALS**  
Corrosion and dirt on the battery and terminals can cause the battery to “leak” power.

1. Remove terminal guard.
2. Disconnect BLACK battery cable first then RED battery cable and remove battery from tractor.
3. Rinse the battery with plain water and dry.
4. Clean terminals and battery cable ends with wire brush until bright.
5. Coat terminals with grease or petroleum jelly.
6. Reinstall battery (See “REPLACING BATTERY” in the Service and Adjustments section of this manual).

### TRANSAXLE COOLING

The transmission fan and cooling fins should be kept clean to assure proper cooling. Do not attempt to clean fan or transmission while engine is running or while the transmission is hot. To prevent possible damage to seals, do not use high pressure water or steam to clean transaxle.

- Inspect cooling fan to be sure fan blades are intact and clean.
- Inspect cooling fins for dirt, grass clippings and other materials. To prevent damage to seals, do not use compressed air or high pressure sprayer to clean cooling fins.

### TRANSAXLE PUMP FLUID

The transaxle was sealed at the factory and fluid maintenance is not required for the life of the transaxle. Should the transaxle ever leak or require servicing, contact your nearest Sears or other qualified service center.

### V-BELTS

Check V-belts for deterioration and wear after 100 hours of operation and replace if necessary. The belts are not adjustable. Replace belts if they begin to slip from wear.

### ENGINE

#### LUBRICATION

Only use high quality detergent oil rated with API service classification SG-SL. Select the oil’s SAE viscosity grade according to your expected operating temperature.

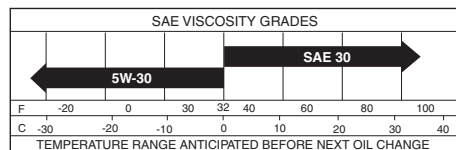

**NOTE:** Although multi-viscosity oils (5W30, 10W30 etc.) improve starting in cold weather, they will result in increased oil consumption when used above 32°F/0°C. Check your engine oil level more frequently to avoid possible engine damage from running low on oil.

Change the oil after every 25 hours of operation or at least once a year if the tractor is not used for 25 hours in one year.

Check the crankcase oil level before starting the engine and after each eight (8) hours of operation. Tighten oil fill cap/dipstick securely each time you check the oil level.

### TO CHANGE ENGINE OIL

Determine temperature range expected before oil change. All oil must meet API service classification SG-SL.

1. Ensure tractor is on level surface.
2. Oil will drain more freely when warm.
3. Catch oil in a suitable container.
4. Remove oil fill cap/dipstick. Be careful not to allow dirt to enter the engine when changing oil.

**CAUTION:** If engine has been operated for an extended period of time immediately prior to draining oil, oil will be hot.

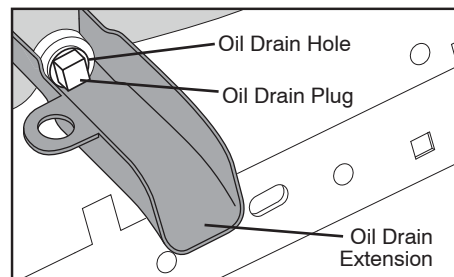

5. Slide oil drain extension under oil drain hole (drain hole may be flush with or protrude from engine block side wall).
6. Ensure back face of oil drain extension is flush with engine side wall.
7. Ensure bottom lip of oil drain extension is lined up with bottom of oil drain hole.
8. Position a container to catch oil directly under front end of oil drain extension.
9. Slide a 1/2" (12 point) socket mounted on an extension onto oil drain plug.
10. Loosen plug while holding the oil drain extension firmly in place.
11. Drain oil into container.
12. After oil has drained completely, reinstall oil drain plug. (Do not tighten more than 13 Ft. Lbs./17 Nm.)

3. Allow one minute for transmission to warm up. This can be done during the engine warm up period.

- The attachments can also be used during the engine warm-up period after the transmission has been warmed up.

### PURGE TRANSMISSION

**CAUTION:** Never engage or disengage freewheel lever while the engine is running. To ensure proper operation and performance, it is recommended that the transmission be purged before operating tractor for the first time. This procedure will remove any trapped air inside the transmission which may have developed during shipping of your tractor.

**IMPORTANT:** Should your transmission require removal for service or replacement, it should be purged after reinstallation before operating the tractor.

1. Place tractor safely on a level surface - that is clear of objects and open - with engine off and parking brake set.
2. Disengage transmission by placing freewheel control in disengaged position (See “TO TRANSPORT” in this section of manual).
3. Sitting in the tractor seat, start engine. After the engine is running, move throttle control to slow position. With motion control lever in neutral position, slowly disengage clutch/brake pedal.

**CAUTION:** At any time, during step 4, there may be movement of the drive wheels.

4. Move motion control lever to full forward position and hold for five (5) seconds. Move lever to full reverse position and hold for five (5) seconds. Repeat this procedure three (3) times.
5. Move motion control lever to neutral position. Shut off engine and set parking brake.
6. Engage transmission by placing freewheel control in engaged position (See “TO TRANSPORT” in this section of manual).
7. Sitting in the tractor seat, start engine. After the engine is running, move throttle control to half (1/2) speed. With motion control lever in neutral position, slowly disengage clutch/brake pedal.
8. Slowly move motion control lever forward, after the tractor moves approximately five (5) feet (1,5 m), slowly move motion control lever to reverse position. After the tractor moves approximately five (5) feet (1,5 m) return the motion control lever to the neutral position. Repeat this procedure with the motion control lever three (3) times.

Your transmission is now purged and now ready for normal operation.

### MOWING TIPS

- DO NOT use tire chains when the mower housing is attached to tractor.
- Mower should be properly leveled for best mowing performance. See “TO LEVEL MOWER HOUSING” in the Service and Adjustments section of this manual.
- The left hand side of mower should be used for trimming.
- Drive so that clippings are discharged onto the area that has already been cut. Have the cut area to the right of the tractor. This will result in a more even distribution of clippings and more uniform cutting.
- When mowing large areas, start by turning to the right so that clippings will discharge away from shrubs, fences, driveways, etc. After one or two rounds, mow in the opposite direction making left hand turns until finished .

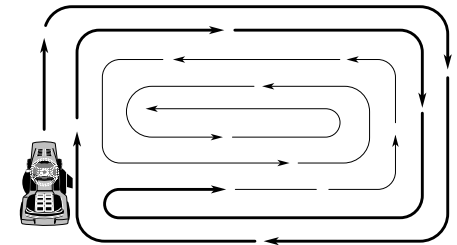

- If grass is extremely tall, it should be mowed twice to reduce load and possible fire hazard from dried clippings. Make first cut relatively high; the second to the desired height.
- Do not mow grass when it is wet. Wet grass will plug mower and leave undesirable clumps. Allow grass to dry before mowing.
- **Always operate engine at full throttle when mowing** to assure better mowing performance and proper discharge of material. Regulate ground speed by selecting a low enough gear to give the mower cutting performance as well as the quality of cut desired.
- When operating attachments, select a ground speed that will suit the terrain and give best performance of the attachment being used.

# MAINTENANCE

MAINTENANCE SCHEDULE		BEFORE EACH USE	EVERY 8 HOURS	EVERY 25 HOURS	EVERY 50 HOURS	EVERY 100 HOURS	EVERY SEASON	BEFORE STORAGE
TRACTOR	Check Brake Operation	✓	✓					
	Check Tire Pressure	✓	✓					
	Check Operator Presence and ROS Systems	✓						
	Check for Loose Fasteners	✓				✓		✓
	Check/Replace Mower Blades			✓ <sub>3</sub>				
	Lubrication Chart			✓				✓
	Check Battery Level			✓ <sub>4</sub>				
	Clean Battery and Terminals			✓ <sub>4</sub>				✓
	Clean Debris off Steering Plate			✓ <sub>5</sub>				
	Check Transaxle Cooling			✓ <sub>5</sub>				
ENGINE	Check Engine Oil Level	✓	✓					
	Change Engine Oil (models with oil filter)				✓ <sub>1,2</sub>			✓
	Change Engine Oil (models without oil filter)			✓ <sub>1,2</sub>				✓
	Clean Air Filter			✓ <sub>2</sub>				
	Clean Air Screen			✓ <sub>2</sub>				
	Inspect Muffler/Spark Arrester				✓			
	Replace Oil Filter (If equipped)					✓ <sub>1,2</sub>		
	Clean Engine Cooling Fins					✓ <sub>2</sub>		
	Replace Spark Plug					✓ <sub>2</sub>	✓	
	Replace Air Filter Paper Cartridge					✓ <sub>2</sub>		
Replace Fuel Filter						✓		

1 - Change more often when operating under a heavy load or in high ambient temperatures  
2 - Service more often when operating in dirty or dusty conditions.

3 - Replace blades more often when mowing in sandy soil.  
4 - Not required if equipped with maintenance-free battery.

5 - See Cleaning in Maintenance Section.

## GENERAL RECOMMENDATIONS

The warranty on this tractor does not cover items that have been subjected to operator abuse or negligence. To receive full value from the warranty, operator must maintain tractor as instructed in this manual.

Some adjustments will need to be made periodically to properly maintain your tractor.

At least once a season, check to see if you should make any of the adjustments described in the Service and Adjustments section of this manual.

- At least once a year you should replace the spark plug, clean or replace air filter, and check blades and belts for wear. A new spark plug and clean air filter assure proper air-fuel mixture and help your engine run better and last longer.

## BEFORE EACH USE

- Check engine oil level.
- Check brake operation.
- Check tire pressure.
- Check operator presence and ROS systems for proper operation.
- Check for loose fasteners.

## LUBRICATION CHART

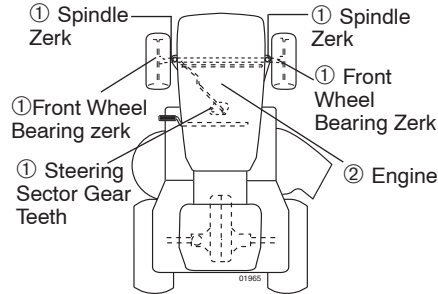

- General Purpose Grease
- Refer to Maintenance "ENGINE" Section.

**IMPORTANT:** Do not oil or grease the pivot points which have special nylon bearings. Viscous lubricants will attract dust and dirt that will shorten the life of the self-lubricating bearings. If you feel they must be lubricated, use only a dry, powdered graphite type lubricant sparingly.

## TRACTOR

Always observe safety rules when performing any maintenance.

## BRAKE OPERATION

If tractor requires more than 5 feet (1,5 m) to stop at highest speed in highest gear on a level, dry concrete or paved surface, then brake must be serviced. (See "TO CHECK BRAKE" in the Service and Adjustments section of this manual).

## TIRES

- Maintain proper air pressure in all tires (See the side of tires for proper PSI.)
- Keep tires free of gasoline, oil, or insect control chemicals which can harm rubber.
- Avoid stumps, stones, deep ruts, sharp objects and other hazards that may cause tire damage.

**NOTE:** To seal tire punctures and prevent flat tires due to slow leaks, tire sealant may be purchased from your local parts dealer. Tire sealant also prevents tire dry rot and corrosion.

## OPERATOR PRESENCE SYSTEM AND REVERSE OPERATION SYSTEM (ROS)

Be sure operator presence and reverse operation systems are working properly. If your tractor does not function as described, repair the problem immediately.

- The engine should not start unless the brake pedal is fully depressed, and the attachment clutch control is in the disengaged position.

## CHECK OPERATOR PRESENCE SYSTEM

- When the engine is running, any attempt by the operator to leave the seat without first setting the parking brake should shut off the engine.
- When the engine is running and the attachment clutch is engaged, any attempt by the operator to leave the seat should shut off the engine.
- The attachment clutch should never operate unless the operator is in the seat.

## CHECK REVERSE OPERATION (ROS) SYSTEM

- When the engine is running with the ignition switch in the engine "ON" position and the attachment clutch engaged, any attempt by the operator to drive in reverse should shut off the engine.
- When the engine is running with the ignition switch in the ROS "ON" position and the attachment clutch engaged, any attempt by the operator to drive in reverse should NOT shut off the engine.



Ros "On" Position



Engine "On" Position (Normal Operating)

## BLADE CARE

For best results mower blades must be sharp. Replace worn, bent or damaged blades.

**CAUTION:** Use only a replacement blade approved by the manufacturer of your tractor. Using a blade not approved by the manufacturer of your tractor is hazardous, could damage your tractor and void your warranty.

## BLADE REMOVAL

- Raise mower to highest position to allow access to blades.

**NOTE:** Protect your hands with gloves and/or wrap blade with heavy cloth.

- Remove blade bolt by turning counterclockwise.
- Install new blade with stamped "GRASS SIDE" facing the ground.

**IMPORTANT:** To ensure proper assembly, center hole in blade must align with star on mandrel assembly.

- Install and tighten blade bolt securely (45-55 Ft. Lbs./62-75 Nm).

**IMPORTANT:** Special blade bolt is heat treated.

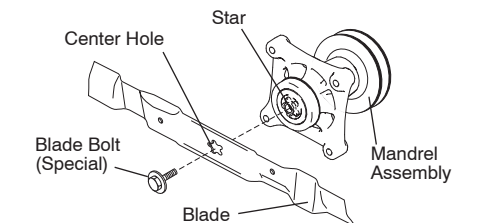

## BATTERY

Your tractor has a battery charging system which is sufficient for normal use. However, periodic charging of the battery with an automotive charger will extend its life.

- Keep battery and terminals clean.
- Keep battery bolts tight.
- Keep small vent holes open.
- Recharge at 6-10 amperes for 1 hour.

**NOTE:** The original equipment battery on your tractor is maintenance free. Do not attempt to open or remove caps or covers. Adding or checking level of electrolyte is not necessary.