

1. To make any engine repairs, contact engine manufacturer.
2. Check for proper oil level in engine.
3. Start engine.
4. Use tachometer to check engine speed @ 3750 RPM, without a load, 3600 RPM with a load.
Set if necessary.
5. Use frequency meter to check for proper frequency:
60 to 62.5 Hz.
6. Use VOM (volt/ohm meter) to check genhead for output.

TO RE-EXCITE GENERATOR

1. If no output, rev engine to full throttle for no more than 3 seconds. This will usually re-excite the genhead if it has lost its residual magnetism.
2. If still no output, shut engine off.
3. Remove end cover screws and end cover from genhead. Remove capacitor leads from capacitor.
NOTE: On the GHC6510 and H650CS remove the two pink capacitor leads from the wire harness not the capacitor. Attach one capacitor lead to one pole of a 6-volt battery (lantern battery) and strike the other capacitor lead across the other pole of the battery so as to cause an arc. Reattach capacitor leads to capacitor. Reassemble end cover. Restart engine to check for output.
4. If still no output, shut engine off.

TO CHECK CAPACITOR

(if generator will not re-excite)

1. Remove end cover screws and end cover from genhead. **NOTE:** The capacitor on the GHC6510 and H650CS is located in the panel assembly, see To Remove Panel Assembly for this unit and proceed.
 - a. Remove capacitor leads.
 - b. Connect VOM to capacitor and watch for low ohms reading that slowly progresses to an open circuit. Open circuit from beginning indicates bad capacitor.

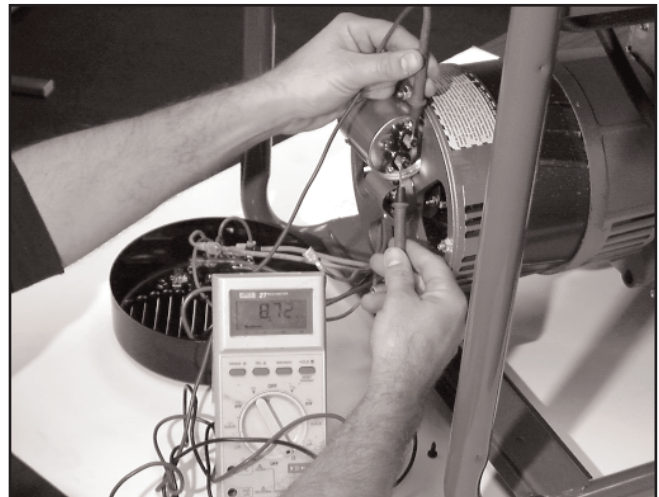

TO CHECK STATOR

(if generator will not re-excite and capacitor is OK)

1. If the capacitor checks okay, check for open circuits in stator.
2. To check for open circuits in stator, attach VOM to the following leads:
 - A. Black- Orange
 - B. Red- Green
 - C. Pink capacitor lead- Pink capacitor lead
 Open circuit indicates bad stator.

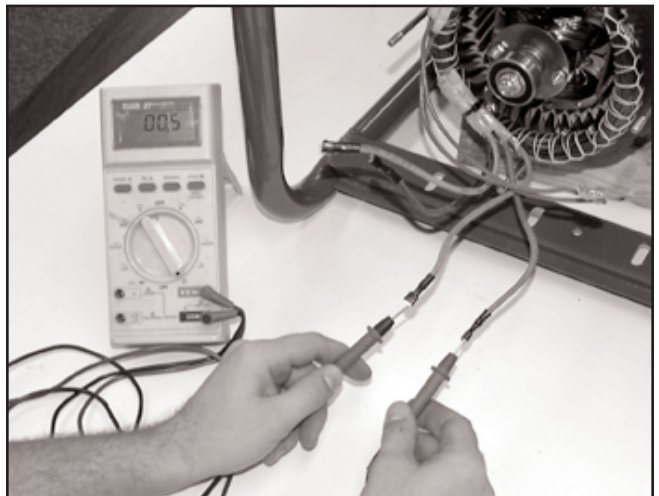

3. If open circuits are not found and there is still a problem, check for circuits grounded in stator. Attach VOM between:
 - A. Black- Stator laminations *
 - B. Red- Stator laminations*
 - C. Pink capacitor leads- Stator laminations*

No reading indicates good stator. No reading will be indicated on meter as OL.

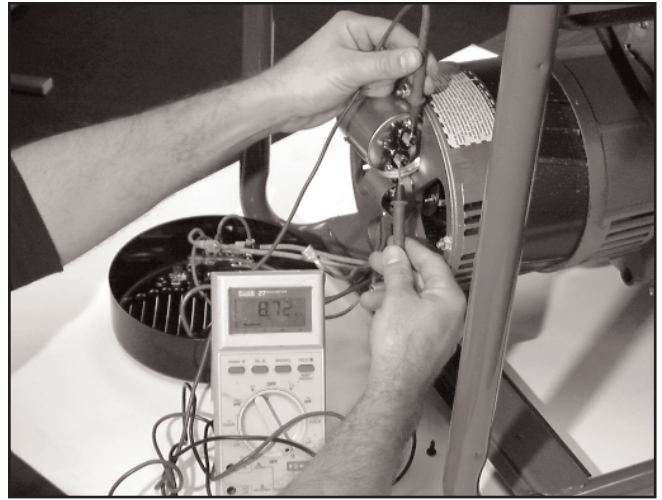

-
4. Attach Vom between black and pink capacitor lead; and red and pink capacitor lead. Your reading should be infinity or OL. If you read zero or above, this indicates bad stator. Most commonly caused by lacings meshed between windings as shown.

* ***Varnish on the laminations must be scraped off to make contact with the metal surface for correct readings.***

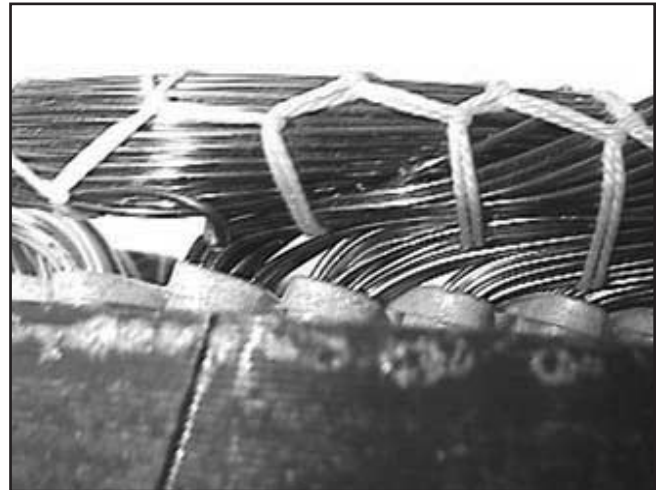

TO CHECK ROTOR (if generator will not re-excite and Stator is OK)

1. If stator checks okay, then check rotor for open circuits. If the rotor has two diodes, remove one diode and attach VOM to solder junction of removed diode to solder junction of the remaining diode. Open circuit indicates bad rotor. If the rotor has one diode, remove the 1/4"-20 nut above the 1/4" female connector and remove from diode bracket. Attach VOM to female connector and solder junction on diode. Open circuit indicates bad rotor.



TO CHECK ROTOR (if generator will not re-excite and Stator is OK) (cont'd)

2. If rotor test indicates no open circuit but double resistance, replace rotor.
3. If open circuits are found, check for short to laminations. Remove 1/4"-20 nut above 1/4" female connector and remove from diode bracket. Attach VOM to female tab and to rotor laminations*. If reading can be made then replace rotor.

* ***Varnish on the laminations must be scraped off to make contact with the metal surface for correct readings.***



TO CHECK DIODES

1. If all checks okay, then check diode(s).
 - a. Remove diode from diode bracket.
 - b. Attach a new AA battery from positive side to diode in the direction indicate by an arrow on the diode.
 - c. Attach VOM to diode for current.
 - d. If using a Fluke 77 or 87 VOM set to symbol and listen for a beep from the meter.

If not using a Fluke 77 or 87 you should get a reading of 1.5. Turn the battery around and you should read 0.7 to 0.9. Any other readings indicates a bad diode.

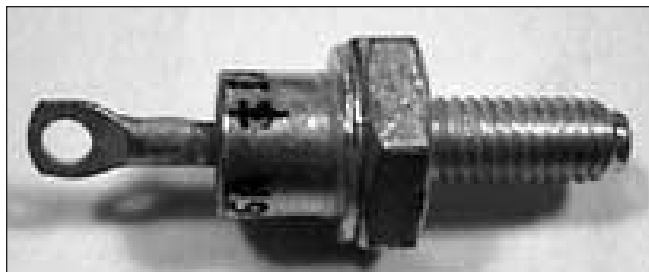
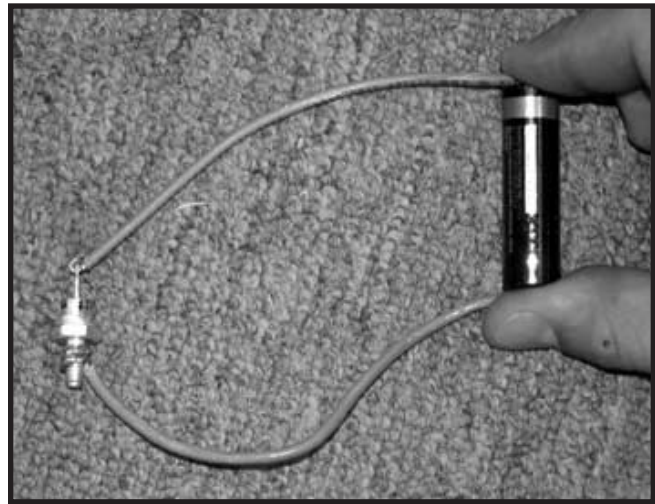

GS-0082

Used on single and dual diode rotors

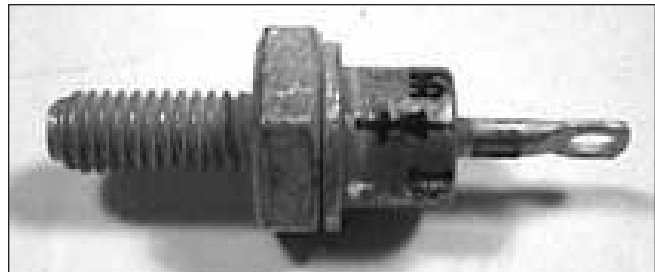

GS-0081

Used on dual diode rotors in conjunction with GS-0082

*This symbol is present on all diodes used on DeVilbiss Generators. The arrow indicates the direction of current flow through the diode. If the arrow points toward the diode bracket, this diode is the GS-0081. If the arrow points toward the soldered junction, this diode is the GS-0082.

Flow of Electricity

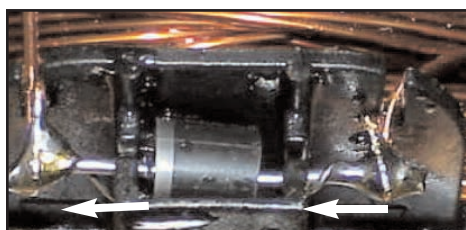

RESISTANCE VALUES IN OHMS @ 70° F

Effective 12-01-02, Highlighted models indicate new generator head design. Verify model number when looking for values.

MODEL NUMBERS	Main Winding	Aux Winding	Rotor	I/C	D/C
	Red to Green	Pink Capacitor Leads			
	Black to Orange				
CH250	.210 - .240	2.55 - 2.72	1.80 - 1.87	N/A	N/A
CH250-1 / D26572	.210 - .240	2.55 - 2.73	1.64 - 1.78	N/A	N/A
CDGT3010-3 / D26576	.210 - .240	2.55 - 2.73	1.64 - 1.78	N/A	N/A
DTE325-2 / D26576	.210 - .240	2.55 - 2.73	1.64 - 1.78	N/A	N/A
DTE325	.210 - .240	2.55 - 2.72	1.80 - 1.87	N/A	N/A
DBSI325	.210 - .240	2.55 - 2.72	1.80 - 1.87	N/A	N/A
DBSI325-1 / D26576	.210 - .240	2.55 - 2.73	1.64 - 1.78	N/A	N/A
CH350CS-2 / D26593	.420 - .480	.110 - .140	1.64 - 1.78	N/A	N/A
CH350CS	.430 - .470	2.66 - 2.83	1.80 - 1.87	.250 - .280	.110 - .140
CTE300	.260 - .280	2.15 - 2.29	1.82 - 1.90	N/A	N/A
CTE300-1 / D26576	.210 - .240	2.55 - 2.73	1.64 - 1.78	N/A	N/A
H450CS	.370 - .400	2.53 - 2.70	1.80 - 1.87	.220 - .250	.110 - .130
T525	.370 - .400	2.50 - 2.65	1.80 - 1.87	N/A	N/A
T550-W	.370 - .400	2.50 - 2.65	1.80 - 1.87	N/A	N/A
BSI550-W-2 / D26605	.250 - .280	1.42 - 1.55	1.61 - 1.74	N/A	N/A
BSI550-W	.260 - .280	1.60 - 1.71	1.80 - 1.87	N/A	N/A
H451CS-W	.220 - .250	1.88 - 2.01	1.33 - 1.42	.150 - .176	.071 - .08
BS500	.430 - .470	2.15 - 2.29	1.81 - 1.92	N/A	N/A
BS525-W	.430 - .470	2.55 - 2.72	1.80 - 1.87	N/A	N/A
BSI525-W-1 / D26598	.420 - .480	2.55 - 2.73	1.62 - 1.78	N/A	N/A
BSI525	.430 - .470	2.55 - 2.72	1.80 - 1.87	N/A	N/A
BS600	.320 - .350	1.50 - 1.60	1.44 - 1.52	N/A	N/A
H650CS	.180 - .150	1.00 - .935	1.52 - 1.43	.170 - .150	.085 - .055
BSV750-W	.130 - .145	.950 - 1.20	1.43 - 1.53	.170 - .210	.082 - .097
BSV800	.160 - .180	1.45 - 1.55	1.43 - 1.52	N/A	N/A
H1000	For values on this model, please go to the bottom of this chart				
H1000 -1 / H1000IS-W	0.08 - .12	.42 - .46	1.44 - 1.58	.15 - .19	.07 - .11
GBP4000 GBV4600	.3 - .6	1.2 - 1.6	.3 - .8	N/A	N/A
GB4000 GB5000	.3 - .6	1.2 - 1.6	.3 - .8	N/A	N/A
GB5000-1 GB5000-2	.3 - .6	1.2 - 1.6	.3 - .8	N/A	N/A
GB5010	.3 - .6	1.2 - 1.6	.3 - .8	N/A	N/A
GBV5000 GBV5000-1	.3 - .6	1.2 - 1.6	.3 - .8	N/A	N/A
GBE4010 GHV4500	.3 - .6	1.2 - 1.6	.3 - .8	N/A	N/A
GB4000-1 GB4000-2	.3 - .6	1.3 - 1.8	.6 - 1.2	N/A	N/A
GB4010	.3 - .6	1.3 - 1.8	.6 - 1.2	N/A	N/A
GB4000-3 GBE4010-1	.3 - .6	2.2 - 2.6	2.0 - 2.3	N/A	N/A
GB5000-3 GB5000-4	.3 - .6	2.2 - 2.6	2.0 - 2.3	N/A	N/A
GT5000 GBP4000-1	.3 - .6	2.2 - 2.6	2.0 - 2.3	N/A	N/A
GT5250 GHV4500-3	.3 - .7	1.7 - 2.1	.6 - 1.6	N/A	N/A
DGHC6510	.180 - .150	1.00 - .935	1.52 - 1.43	.170 - .150	.085 - .055
GBFE6010	.4 - .7	1.7 - 2.1	1.7 - 2.0	N/A	N/A
GBV7000 GBV7000-1	0 - .3	.6 - 1.1	.5 - .9	N/A	N/A
GBV7000-2 GBV7010	0 - .3	.6 - 1.1	.5 - .9	N/A	N/A
GBV7000-3	0 - .3	.6 - 1.1	.5 - .9	N/A	N/A
GBV7000-4	.2 - .6	.6 - 1.3	.9 - 1.7	N/A	N/A
CGTP3000-3 / D26576	.210 - .240	2.55 - 2.73	1.64 - 1.78	N/A	N/A
CGPT3000	.4 - .7	2.3 - 2.7	1.9 - 2.3	N/A	N/A
CGBV4000	.3 - .7	2	2.0 - 2.3	.3 - .6	.3 - .6
GBVE8000	.160 - .180	1.45 - 155	1.43 - 1.52	N/A	N/A

3600rpm 120-240v 60 Hz

H1000	R2-160	Stator	Rotor	Excitation
	R2-200	4.67	0.109	1.3
		5.23	0.075	1.05

TO CHECK IDLE CONTROL SWITCH

1. Remove the Panel Assembly. See To Remove Panel Assembly in the Disassembly Procedures section of this manual.
2. Place idle control switch in the OFF position.
3. Remove the two screws from the front of idle control switch.
4. Disconnect wire harness from idle control switch.

Models with Idle Control Switch

H1000	H1000-1	H1000IS
H650CS		
H450CS	H450CS-1	
H45ICS-W		
CH350CS		
CH350IS		
BSV750-W		



CGBV4000 PANEL ASSEMBLY

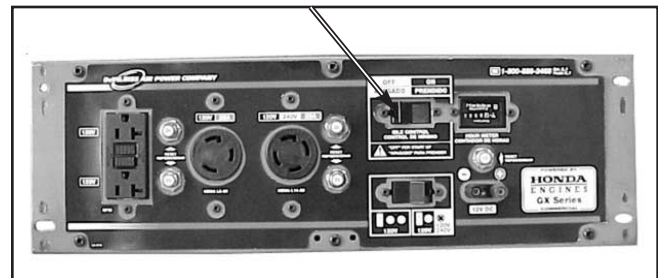

GHC6510 PANEL ASSEMBLY

-
5. Remove idle control switch and attach the VOM (volt/ohm meter).
 6. Turn idle control switch to the ON position.
A low reading = a good idle control switch
No reading = a bad idle control switch

NOTE: Always place idle control switch to the OFF position when replacing old or new.

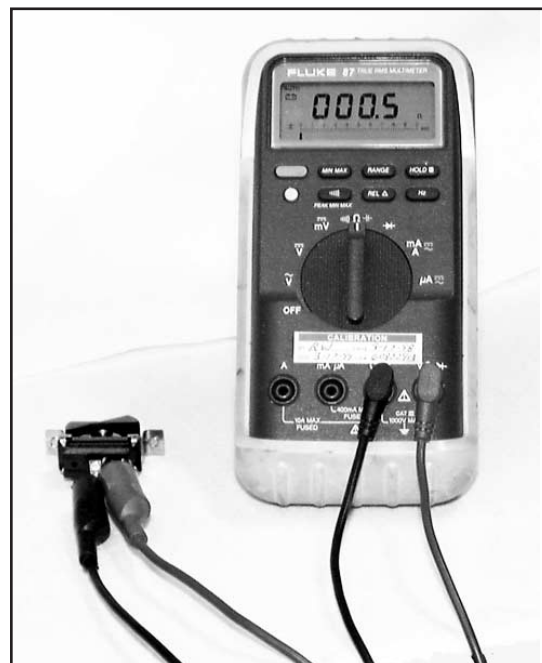

TO CHECK SOLENOID (CGBV4000)

1. Unhook wire harness from solenoid.
2. Loosen nut on end of solenoid. **DO NOT** remove.
3. Solenoid will now slide from bracket.
4. Connect VOM (volt/ohm meter) to solenoid leads. Set VOM (volt/ohm meter) to read

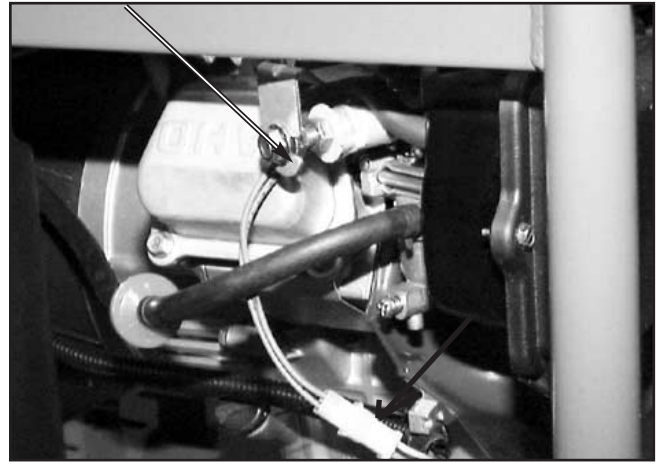

OHMS, the reading should be 150 + or - 10 OHMS. If no reading the solenoid is bad.

5. Reconnect wire harness to solenoid.
6. Start the generator and place the idle control switch in the ON position. With generator running and idle control in the ON position the solenoid should be magnetized, if you place the solenoid to the frame it should stick. If solenoid is not magnetic check stator.

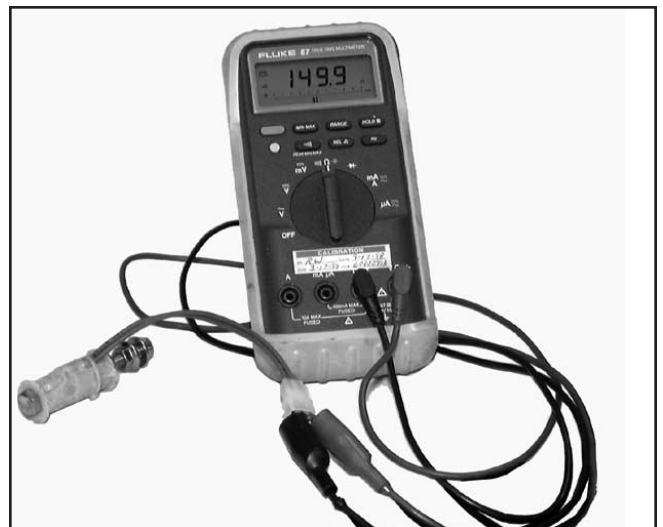

(GHC6510 & GH8400CS-W)

1. Disconnect the solenoid from the wire harness.
2. Connect the VOM meter to the brass tabs inside the connector, the VOM meter should be 26 + or - 1.

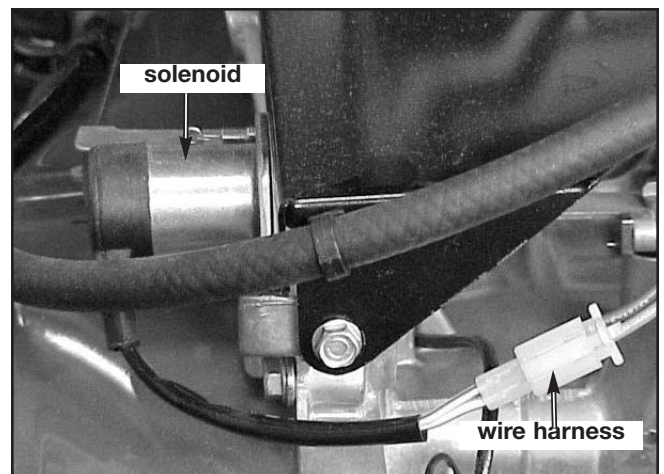

CHECK STATOR

(if solenoid is no longer magnetic)

1. Turn the generator off and allow it to cool before checking stator.
2. To check stator for resistance remove the end cover. See To Remove End Cover in the Disassembly section.
3. Attach the VOM (volt/ohm meter) to the two white leads on the stator. Set VOM (volt/ohm meter) to read OHMS, the reading should be .05 OHMS, if no reading the stator is bad.
4. Attach the VOM (volt/ohm meter) to one white lead on the stator and the stator laminations. Set VOM (volt/ohm meter) to read OHMS, no reading indicates a bad stator.

NOTE: If stator is bad, replace and recheck solenoid for magnetism. If the solenoid is not magnetized and the stator is good then replace the circuit board.

*** Varnish on the laminations must be scraped off to make contact with the metal surface for correct readings.**

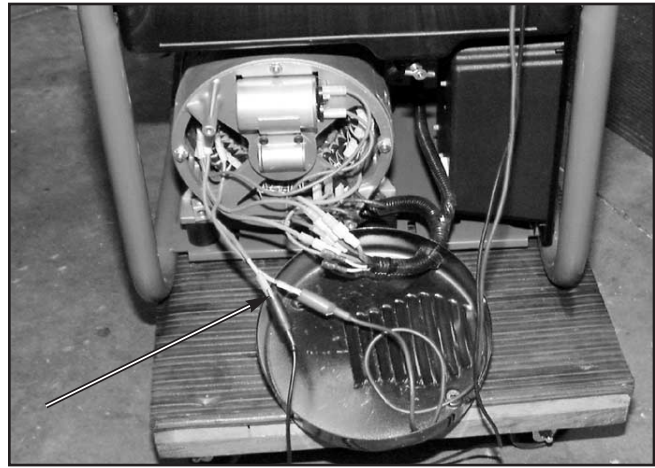

REPLACE OR REASSEMBLE SOLENOID (CGBV4000)

1. Thread the back nut all the way up to the solenoid.
2. Slide solenoid into bracket.
3. Thread the front nut only until the end of the solenoid is flush with the nut.
4. Connect the VOM (volt/ohm meter) to the 120-volt outlet.
5. Start the generator and place the idle control switch into the ON position. At this time the magnetism of the solenoid will pull it into place.

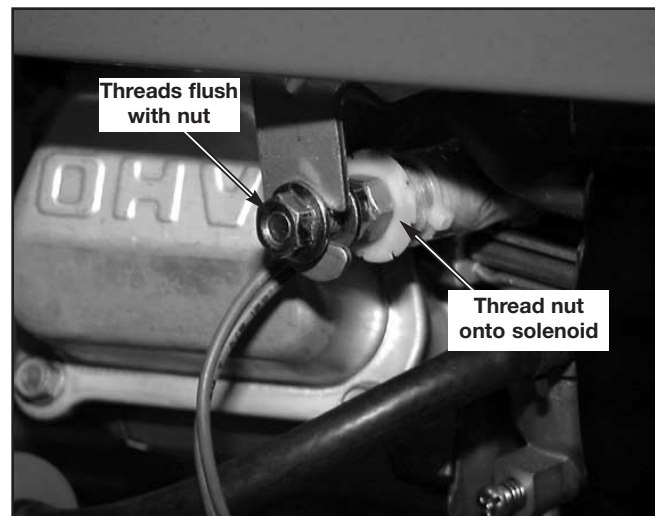

6. The VOM (volt/ohm meter) should read 60 Hertz.
7. Thread the front nut onto the solenoid until the VOM (volt/ohm meter) reads 45 Hertz.
8. Using wrenches tighten the back nut tight against bracket while holding the front nut in place. **MAKE SURE** reading remains at 45 Hertz when tightened.
9. Turn the idle control switch to the OFF position and the VOM (volt/ohm meter) will return to 60 Hertz.

(GHC6510)

1. Reconnect solenoid leads to the wire harness.



**TO REPLACE SOLENOID
(GHC6510 & H650CS)**

1. Using a 10 mm socket remove the heatshield.
2. Using Phillips screw driver remove the screws holding the solenoid in place.
3. Slide arm from the solenoid and remove.
4. Replace the solenoid in reverse order.

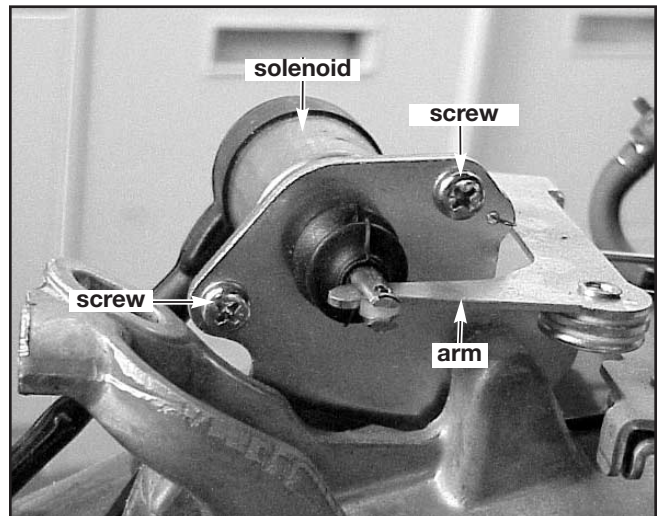
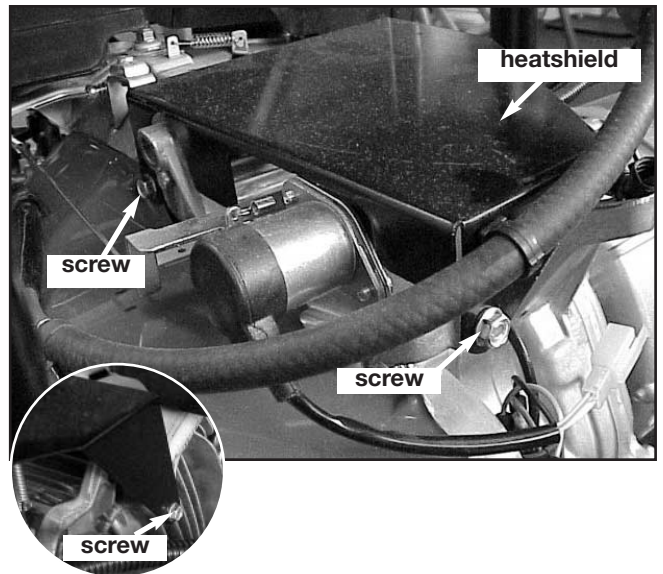

TO SET THE ENGINE IDLE SPEED (GHC6510)

1. Connect the VOM (volt/ohm meter) to the 120-volt GFCI outlet.



2. Using Phillips screw driver turn the screw on the carburetor left or right until the VOM (volt/ohm meter) reaches 45 Hertz. **MAKE SURE** reading remains at 45 Hertz when tightened.
3. Turn the idle control switch to the OFF position and the VOM (volt/ohm meter) will return to 60 Hertz.



TO REPLACE THE CIRCUIT BOARD (CGBV4000)

1. Remove the Panel Assembly. See To Remove Panel Assembly in the Disassembly Procedures section of this manual.
2. Disconnect circuit board from wire harness and replace with new.
3. Reassemble the panel assembly in reverse order of removal.

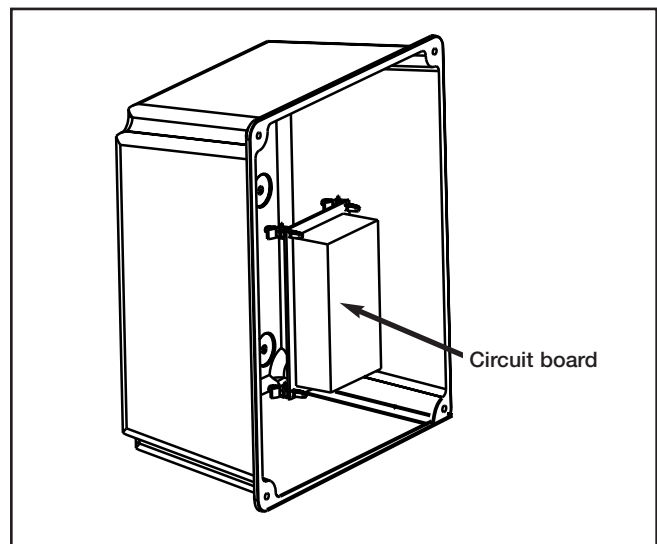

(GHC6510 & H650CS)

1. Remove the Panel Assembly. See To Remove Panel Assembly in the Disassembly Procedures section of this manual.
2. Disconnect circuit board from wire harness and replace with new.
3. Reassemble in reverse order. **NOTE:** When reassembling, attach capacitor and bracket, circuit board, and plug before attaching the front panel to back panel.

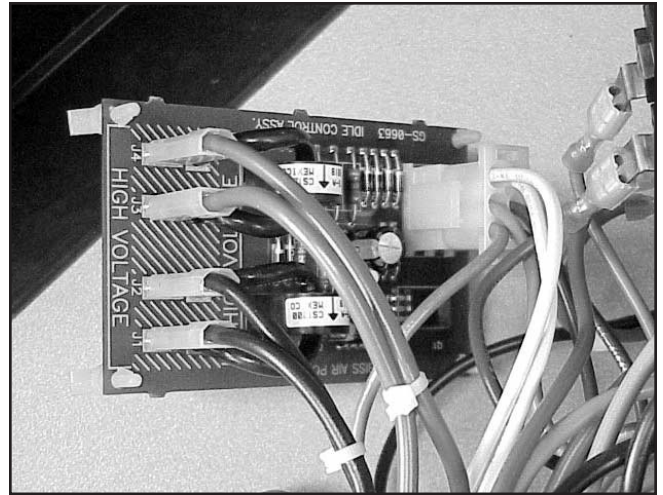

TO CHECK AND REPLACE THE RECTIFIER (CGBV4000 and GHC6510)

1. To check stator for resistance remove the end cover. See To Remove End Cover in the Disassembly section.
2. Attach the VOM (volt/ohm meter) to the two yellow leads on the stator. Set VOM (volt/ohm meter) to read OHMS, the reading should be .07 OHMS, if no reading the stator is bad.
3. Attach the VOM (volt/ohm meter) to one yellow lead on the stator and the stator laminations. Set VOM (volt/ohm meter) to read OHMS, no reading indicates a bad stator.

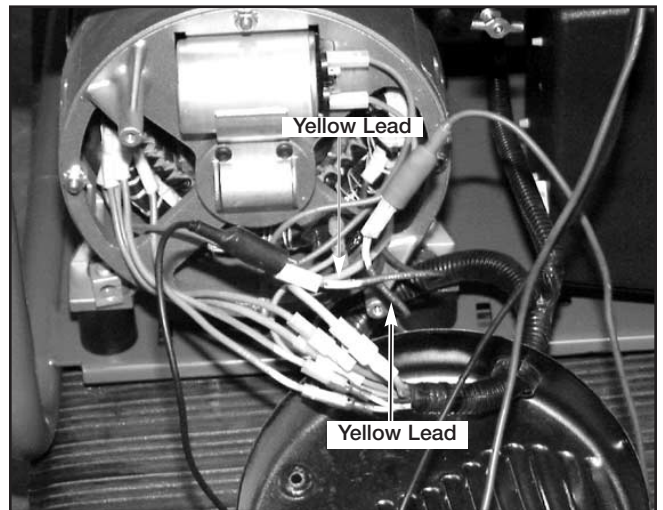

* ***Varnish on the laminations must be scraped off to make contact with the metal surface for correct readings.***

NOTE: If all readings are OK replace the rectifier.

