

# GENERAL MANUAL FOR PERMANENTLY LUBRICATED PORTABLE/STATIONARY AIR COMPRESSOR

## TABLE OF CONTENTS

<p><b>SAFETY GUIDELINES</b> ..... 1</p> <p><b>WARRANTY STATEMENT</b> ..... 2</p> <p><b>WARNING CHART</b> ..... 3-4</p> <p><b>GLOSSARY</b> ..... 5</p> <p><b>DUTY CYCLE</b> ..... 5</p> <p><b>GENERAL INFORMATION</b> ..... 5</p> <p><b>ON-RECEIPT INSPECTION</b> ..... 5</p> <p><b>DESCRIPTION OF OPERATION</b> ..... 6</p> <p><b>ASSEMBLY (PORTABLE UNITS)</b> ..... 6</p> <p style="padding-left: 20px;">Items Needed for Assembly ..... 6</p> <p style="padding-left: 20px;">Installing Wheels, Handles</p> <p style="padding-left: 20px;">Rubber Foot Strip ..... 6</p> <p><b>INSTALLATION AND BREAK-IN PROCEDURES</b> ..... 7-8</p> <p style="padding-left: 20px;">Location of Air Compressor ..... 7</p>	<p>Air Compressor Anchoring Methods (Stationary Units) ..... 7</p> <p>Lubrication and Oil ..... 7</p> <p>Extension Cords ..... 7</p> <p>Voltage and Current Protection ..... 7</p> <p>Piping ..... 7</p> <p>Grounding Instructions ..... 8</p> <p>Additional Regulators &amp; Controls ..... 8</p> <p>Break-in Procedures ..... 8</p> <p><b>OPERATING PROCEDURES</b> ..... 8-9</p> <p style="padding-left: 20px;">Daily Start-up Checklist ..... 8</p> <p><b>MAINTENANCE</b> ..... 9</p> <p style="padding-left: 20px;">Air Filter - Inspection and Replacement ..... 9</p> <p style="padding-left: 20px;">Safety Valve - Inspection ..... 9</p> <p style="padding-left: 20px;">External Brass Check Valve Replacement ..... 9</p> <p style="padding-left: 20px;">Motor ..... 9</p> <p style="padding-left: 20px;">Motor Replacement - Wiring Diagram ..... 9</p> <p><b>STORAGE</b> ..... 10</p> <p><b>TROUBLESHOOTING GUIDE</b> ..... 10-11</p> <p><b>SERVICE NOTES</b> ..... Back Cover</p>
--	---

### SAFETY GUIDELINES - DEFINITIONS

This manual contains information that is important for you to know and understand. This information relates to protecting **YOUR SAFETY** and **PREVENTING EQUIPMENT PROBLEMS**. To help you recognize this information, we use the symbols to the right. Please read the manual and pay attention to these sections.

#### ⚠ DANGER

**URGENT SAFETY INFORMATION - A HAZARD THAT WILL CAUSE SERIOUS INJURY OR LOSS OF LIFE.**

#### ⚠ CAUTION

Information for preventing damage to equipment.

#### ⚠ WARNING

**IMPORTANT SAFETY INFORMATION - A HAZARD THAT MIGHT CAUSE SERIOUS INJURY OR LOSS OF LIFE.**

#### NOTE

Information that you should pay special attention to.

Call our **Toll Free Number 1-800-888-2468, Ext 2, then 1**, to obtain the location of the nearest Authorized Service Center for ordering repair parts and for warranty repairs.

When ordering repair parts from your local Authorized Service Center, always give the following information:

- Model number of your compressor
- Part number and description of the item you wish to purchase

**Retain Original Sales Receipt as Proof of Purchase for Warranty Repair Work.**

## **LIMITED WARRANTY ONE YEAR FROM DATE OF PURCHASE**

All merchandise manufactured by DeVilbiss Air Power Company/ExCell Manufacturing is warranted to be free of defects in workmanship and material which occur during the first year from the date of purchase by the original purchaser (initial user). Products covered under this warranty include: air compressors, \*air tools, accessories, service parts, pressure washers, and generators used in consumer applications (i.e., personal residential household usage only).

Air compressors, \*air tools, accessories, service parts, pressure washers, and generators used in commercial applications (income producing) are covered by a 90 day warranty.

DeVilbiss Air Power/ExCell Manufacturing will repair or replace, at DeVilbiss/ExCell's option, products or components which have failed within the warranty period. Repair or replacement, and service calls on 60 and 80 gallon air compressors, will be handled by Authorized Warranty Service Centers and will be scheduled and serviced according to the normal work flow and business hours at the service center location, and depending on the availability of replacement parts.

All decisions of DeVilbiss Air Power Company/ExCell Manufacturing with regard to this policy shall be final.

This warranty gives you specific legal rights, and you may also have other rights which vary from state to state.

### **RESPONSIBILITY OF ORIGINAL PURCHASER (Initial User):**

- Retain original cash register sales receipt as proof of purchase for warranty work.
- Use reasonable care in the operation and maintenance of the product as described in the Owners Manual(s).
- Deliver or ship the product to the nearest DeVilbiss Air Power/ExCell Manufacturing Authorized Warranty Service Center. Freight costs, if any, must be paid by the purchaser.
- Air compressors with 60 and 80 gallon tanks only will be inspected at the site of installation. Contact the nearest Authorized Warranty Service Center, that provides on-site service calls, for service call arrangement.
- If the purchaser does not receive satisfactory results from the Authorized Warranty Service Center, the purchaser should contact DeVilbiss Air Power Company/ExCell Manufacturing.

### **THIS WARRANTY DOES NOT COVER:**

- Merchandise sold as reconditioned, floor models and/or display models. Any damaged or incomplete equipment sold "as is".
- Merchandise used as "rental" equipment.
- Merchandise that has become inoperative because of ordinary wear, misuse, freeze damage, use of improper chemicals, negligence, accident, improper and/or unauthorized repair or alterations including failure to operate the product in accordance with the instructions provided in the Owners Manual (s) supplied with the product.  
\*Air Tools: O-Rings and driver blades are considered ordinary wear parts, therefore, they are warranted for a period of 45 days from the date of purchase.
- An air compressor that pumps air more than 50% during a one hour period is considered misuse because the air compressor is undersized for the required air demand. Maximum compressor pumping time per hour is 30 minutes.
- Merchandise sold by DeVilbiss Air Power/ExCell Manufacturing which has been manufactured by and identified as the product of another company. The product manufacturer's warranty will apply.
- Repair and transportation costs of merchandise determined not to be defective.
- Cost associated with assembly, required oil, adjustments or other installation and start-up cost.
- ANY INCIDENTAL, INDIRECT OR CONSEQUENTIAL LOSS, DAMAGE, OR EXPENSE THAT MAY RESULT FROM ANY DEFECT, FAILURE OR MALFUNCTION OF THE PRODUCT.** Some states do not allow the exclusion or limitation of incidental or consequential damages, so the above limitation or exclusion may not apply to you.
- IMPLIED WARRANTIES, INCLUDING THOSE OF MERCHANTABILITY AND FITNESS FOR A PARTICULAR PURPOSE, ARE LIMITED TO ONE YEAR FROM THE DATE OF ORIGINAL PURCHASE.** Some states do not allow limitations on how long an implied warranty lasts, so the above limitations may not apply to you.



# IMPORTANT SAFETY INSTRUCTIONS



• **SAVE THESE INSTRUCTIONS** •







**IMPROPER OPERATION OR MAINTENANCE OF THIS PRODUCT COULD RESULT IN SERIOUS INJURY AND PROPERTY DAMAGE. READ AND UNDERSTAND ALL WARNINGS AND OPERATING INSTRUCTIONS BEFORE USING THIS EQUIPMENT.**

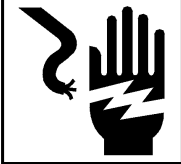

## ⚠ WARNING

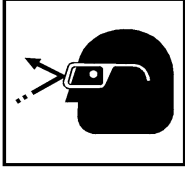
HAZARD	WHAT CAN HAPPEN	HOW TO PREVENT IT
<p><b>RISK OF BURSTING</b></p> 	<p><b>AIR TANK</b></p> <p><b>THE FOLLOWING CONDITIONS COULD LEAD TO A WEAKENING OF THE TANK, AND RESULT IN A VIOLENT TANK EXPLOSION:</b></p> <ol style="list-style-type: none"> <li><b>FAILURE TO PROPERLY DRAIN CONDENSED WATER FROM THE TANK,</b> CAUSING RUST AND THINNING OF THE STEEL TANK.</li> <li><b>MODIFICATIONS</b> OR ATTEMPTED REPAIRS <b>TO THE TANK.</b></li> <li>UNAUTHORIZED <b>MODIFICATIONS TO THE PRESSURE SWITCH, SAFETY VALVE, OR ANY OTHER COMPONENTS WHICH CONTROL TANK PRESSURE.</b></li> </ol> <p><b>ATTACHMENTS &amp; ACCESSORIES</b></p> <p><b>EXCEEDING THE PRESSURE RATING OF AIR TOOLS, SPRAY GUNS, AIR OPERATED ACCESSORIES, TIRES AND OTHER INFLATABLES CAN CAUSE THEM TO EXPLODE</b> OR FLY APART, AND COULD RESULT IN SERIOUS INJURY.</p> <p><b>EXCESSIVE VIBRATION CAN WEAKEN THE AIR TANK</b> OF A STATIONARY COMPRESSOR AND <b>CAUSE AN EXPLOSION.</b></p>	<p><b>DRAIN TANK DAILY OR AFTER EACH USE.</b> IF TANK DEVELOPS A LEAK, REPLACE IT IMMEDIATELY WITH A NEW TANK OR NEW COMPRESSOR OUTFIT.</p> <p><b>NEVER DRILL INTO, WELD, OR MAKE ANY MODIFICATIONS TO THE TANK</b> OR ITS ATTACHMENTS.</p> <p>THE TANK IS DESIGNED TO WITHSTAND SPECIFIC OPERATING PRESSURES. <b>NEVER MAKE ADJUSTMENTS OR PARTS SUBSTITUTIONS TO ALTER THE FACTORY SET OPERATING PRESSURES.</b></p> <p>FOLLOW THE EQUIPMENT MANUFACTURERS RECOMMENDATION AND NEVER EXCEED THE MAXIMUM ALLOWABLE PRESSURE RATING OF ATTACHMENTS. <b>NEVER USE COMPRESSOR TO INFLATE SMALL LOW-PRESSURE OBJECTS SUCH AS CHILDREN'S TOYS, FOOTBALLS, BASKETBALLS, ETC.</b></p> <p>THE <b>COMPRESSOR MUST BE PROPERLY MOUNTED,</b> SEE INSTALLATION PROCEDURES.</p>
<p><b>RISK OF EXPLOSION OR FIRE</b></p>  	<p><b>IT IS NORMAL FOR ELECTRICAL CONTACTS</b> WITHIN THE MOTOR AND PRESSURE SWITCH <b>TO SPARK.</b></p> <p><b>IF ELECTRICAL SPARKS FROM COMPRESSOR COME INTO CONTACT WITH FLAMMABLE VAPORS, THEY MAY IGNITE, CAUSING FIRE OR EXPLOSION.</b></p> <p><b>RESTRICTING ANY OF THE COMPRESSOR VENTILATION OPENINGS WILL CAUSE SERIOUS OVERHEATING AND COULD CAUSE FIRE.</b></p>	<p>ALWAYS <b>OPERATE THE COMPRESSOR IN A WELL VENTILATED AREA FREE OF COMBUSTIBLE MATERIALS, GASOLINE OR SOLVENT VAPORS.</b></p> <p>IF SPRAYING FLAMMABLE MATERIALS, <b>LOCATE COMPRESSOR AT LEAST 20 FEET AWAY FROM SPRAY AREA.</b> AN ADDITIONAL LENGTH OF HOSE MAY BE REQUIRED.</p> <p><b>STORE FLAMMABLE MATERIALS IN A SECURE LOCATION AWAY FROM COMPRESSOR.</b></p> <p><b>NEVER PLACE OBJECTS AGAINST OR ON TOP OF COMPRESSOR. OPERATE COMPRESSOR</b> IN AN OPEN AREA AT LEAST <b>12 INCHES AWAY FROM ANY WALL OR OBSTRUCTION</b> THAT WOULD RESTRICT THE FLOW OF FRESH AIR TO THE VENTILATION OPENINGS.</p>
<p><b>RISK OF ELECTRICAL SHOCK</b></p> 	<p>YOUR <b>AIR COMPRESSOR IS POWERED BY ELECTRICITY.</b> LIKE ANY OTHER ELECTRICALLY POWERED DEVICE, <b>IF IT IS NOT USED PROPERLY IT MAY CAUSE ELECTRIC SHOCK.</b></p>	<p>NEVER OPERATE THE COMPRESSOR OUTDOORS WHEN IT IS RAINING OR IN WET CONDITIONS.</p> <p><b>NEVER OPERATE COMPRESSOR WITH COVER COMPONENTS REMOVED</b> OR DAMAGED.</p>

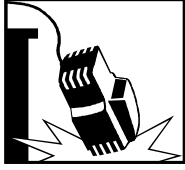
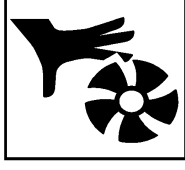
CONTINUE NEXT PAGE ➡

HAZARD	WHAT CAN HAPPEN	HOW TO PREVENT IT
<p><b>RISK OF ELECTRICAL SHOCK (cont'd)</b></p> 	<p><b><u>REPAIRS ATTEMPTED BY UNQUALIFIED PERSONNEL CAN RESULT IN SERIOUS INJURY OR DEATH BY ELECTROCUTION.</u></b></p> <p>ELECTRICAL GROUNDING: <b><u>FAILURE TO PROVIDE ADEQUATE GROUNDING TO THIS PRODUCT COULD RESULT IN SERIOUS INJURY OR DEATH FROM ELECTROCUTION.</u></b> SEE GROUNDING INSTRUCTIONS.</p>	<p>ANY <b><u>ELECTRICAL WIRING OR REPAIRS</u></b> REQUIRE ON THIS PRODUCT <b><u>SHOULD BE PERFORMED BY AUTHORIZED SERVICE CENTER PERSONNEL</u></b>, IN ACCORDANCE WITH NATIONAL AND LOCAL ELECTRICAL CODES.</p> <p><b><u>MAKE CERTAIN THAT THE ELECTRICAL CIRCUIT TO WHICH THE COMPRESSOR IS CONNECTED PROVIDES PROPER ELECTRICAL GROUNDING, CORRECT VOLTAGE AND ADEQUATE FUSE PROTECTION.</u></b></p>
<p><b>RISK FROM FLYING OBJECTS</b></p> 	<p>THE <b><u>COMPRESSED AIR</u></b> STREAM <b><u>CAN CAUSE SOFT TISSUE DAMAGE</u></b> TO EXPOSED SKIN <b><u>AND CAN PROPEL</u></b> DIRT, CHIPS, <b><u>LOOSE PARTICLES</u></b> AND SMALL OBJECTS AT <b><u>HIGH SPEED</u></b>, RESULTING IN PROPERTY DAMAGE OR PERSONAL INJURY.</p>	<p><b><u>ALWAYS WEAR ANSI Z87.1 APPROVED SAFETY GLASSES WITH SIDE SHIELDS</u></b> WHEN USING THE COMPRESSOR.</p> <p><b><u>NEVER POINT ANY NOZZLE OR SPRAYER TOWARD ANY PART OF THE BODY OR AT OTHER PEOPLE OR ANIMALS.</u></b></p> <p><b><u>ALWAYS TURN THE COMPRESSOR OFF AND BLEED PRESSURE</u></b> FROM THE AIR LINE <b><u>BEFORE ATTEMPTING MAINTENANCE, ATTACHING TOOLS</u></b> OR ACCESSORIES.</p>
<p><b>RISK TO BREATHING</b></p> 	<p>THE <b><u>COMPRESSED AIR</u></b> FROM YOUR COMPRESSOR <b><u>IS NOT SAFE FOR BREATHING!</u></b> THE AIR STREAM MAY CONTAIN CARBON MONOXIDE, TOXIC VAPORS OR SOLID PARTICLES.</p> <p><b><u>SPRAYED MATERIALS</u></b> SUCH AS PAINT, PAINT SOLVENTS, PAINT REMOVER, INSECTICIDES, WEED KILLERS, ETC., <b><u>CONTAIN HARMFUL VAPORS</u></b> AND POISONS.</p>	<p><b><u>NEVER INHALE AIR FROM THE COMPRESSOR</u></b> EITHER DIRECTLY OR FROM A BREATHING DEVICE CONNECTED TO THE COMPRESSOR.</p> <p><b><u>WORK IN AN AREA WITH GOOD CROSS-VENTILATION.</u></b> READ AND <b><u>FOLLOW THE SAFETY INSTRUCTIONS</u></b> PROVIDED ON THE LABEL OR SAFETY DATA SHEETS <b><u>FOR THE MATERIAL YOU ARE SPRAYING.</u></b> <b><u>USE A NIOSH/MSHA APPROVED RESPIRATOR</u></b> DESIGNED FOR USE WITH YOUR SPECIFIC APPLICATION.</p>
<p><b>RISK OF FALLING</b></p> 	<p>A PORTABLE <b><u>COMPRESSOR CAN FALL</u></b> FROM A TABLE, WORKBENCH OR ROOF <b><u>CAUSING DAMAGE TO THE COMPRESSOR WHICH COULD RESULT IN SERIOUS INJURY.</u></b></p>	<p><b><u>ALWAYS OPERATE COMPRESSOR IN A STABLE SECURE POSITION</u></b> TO PREVENT ACCIDENTAL MOVEMENT OF THE UNIT. <b><u>NEVER OPERATE COMPRESSOR ON A ROOF OR OTHER ELEVATED POSITION.</u></b> <b><u>USE ADDITIONAL AIR HOSE TO REACH HIGH LOCATIONS.</u></b></p>
<p><b>RISK FROM MOVING PARTS</b></p> 	<p>THE <b><u>COMPRESSOR CYCLES AUTOMATICALLY</u></b> WHEN THE PRESSURE SWITCH IS IN THE <b><u>ON/AUTO POSITION</u></b></p> <p><b><u>MOVING PARTS CAN CAUSE SERIOUS INJURY</u></b> OR DAMAGE IF THEY COME INTO CONTACT WITH YOU OR YOUR CLOTHING.</p> <p><b><u>ATTEMPTING TO OPERATE OR REPAIR COMPRESSOR WITH PROTECTIVE SHROUDS REMOVED CAN EXPOSE YOU TO MOVING PARTS AND ELECTRICAL SHOCK.</u></b></p>	<p><b><u>ALWAYS TURN OFF THE COMPRESSOR, BLEED PRESSURE FROM THE AIR HOSE, AND UNPLUG FROM ELECTRICAL OUTLET BEFORE PERFORMING MAINTENANCE OR ATTACHING TOOLS AND ACCESSORIES.</u></b></p> <p><b><u>DO NOT REMOVE THE PROTECTIVE COVERS</u></b> FROM THIS PRODUCT. <b><u>NEVER OPERATE THE COMPRESSOR WITH GUARDS</u></b> OR COVERS WHICH ARE DAMAGED OR <b><u>REMOVED.</u></b></p> <p>ANY <b><u>REPAIRS</u></b> REQUIRED ON THIS <b><u>PRODUCT SHOULD BE PERFORMED BY AUTHORIZED SERVICE CENTER PERSONNEL.</u></b></p>
<p><b>RISK OF BURNS</b></p> 	<p><b><u>TOUCHING EXPOSED METAL</u></b> SUCH AS THE COMPRESSOR HEAD OR OUTLET TUBE <b><u>CAN RESULT IN SERIOUS BURNS.</u></b></p>	<p><b><u>NEVER TOUCH ANY EXPOSED METAL PARTS ON COMPRESSOR</u></b> DURING OR IMMEDIATELY AFTER OPERATION. <b><u>COMPRESSOR WILL REMAIN HOT</u></b> FOR SEVERAL MINUTES AFTER OPERATION.</p>

---

## GLOSSARY

---

**CFM:** Cubic feet per minute.

**SCFM:** Standard cubic feet per minute; a unit of measure of air delivery.

**PSIG:** Pounds per square inch gauge; a unit of measure of pressure.

**ASME:** American Society of Mechanical Engineers; made, tested, inspected and registered to meet the standards of ASME.

**California Code:** Unit may comply with California Code 462 (L) (2)/(M) (2). Specification/model label is on the side of the tank on units that comply with California Code.

**Cut-In Pressure:** While the motor is off, air tank pressure drops as you continue to use your accessory or air tool.

When the tank pressure drops to a certain low level the motor will restart automatically. The low pressure at which the motor automatically restarts is called “cut-in pressure.”

**Cut-Out Pressure:** When you turn on your air compressor and it begins to run, air pressure in the air tank begins to build. It builds to a certain high pressure before the motor automatically shuts off - protecting your air tank from pressure higher than its capacity. The high pressure at which the motor shuts off is called “cut-out pressure.”

**U.L. Listed:** Products with the U.L. mark are listed by Underwriters Laboratories, Inc. (U.L.). Samples of these products have been evaluated by U.L. and meet the applicable U.L. standards for safety.

---

## DUTY CYCLE

---

All DeVilbiss Air Power manufactured air compressors should be operated on not more than a 50% duty cycle. This means an air compressor that pumps air more than 50% of one hour is

considered misuse, because the air compressor is undersized for the required air demand. Maximum compressor pumping time per hour is 30 minutes.

---

## GENERAL INFORMATION

---

You have purchased an air compressor unit consisting of a 1 cylinder, single-stage air compressor pump, an air tank, and associated controls and instruments.

This air compressor requires no oil. Now you can enjoy all the benefits of having an air compressor without ever having to purchase, add or change oil.

Your air compressor can be used for operating paint spray

guns, air tools, caulking guns, grease guns, air brushes, sandblaster, or inflating tires and plastic toys, spraying weed killers, insecticides, etc. An air pressure regulator is necessary for most of these applications.

Separate air transformers which combine the functions of air regulation and/or moisture and dirt removal should be used where applicable.

---

## ON-RECEIPT INSPECTION

---

**DAMAGE:** Each air compressor outfit is carefully tested and checked before shipment. With improper handling, damage may result in transit and cause problems in compressor operation.

Immediately upon arrival, check equipment for both concealed

and visible damages to avoid expenses being incurred to correct such problems. This should be done regardless of any visible signs of damage to the shipping container. If this product was shipped directly to you, report any damages to carrier and arrange for inspection of goods immediately.

---

## DESCRIPTION OF OPERATION

---

**Drain Valve:** The drain valve is located at the base of the air tank and is used to drain condensation at the end of each use.

**Motor Thermal Overload Protector:** The electric motor has an automatic thermal overload protector. If the motor overheats for any reason, the thermal overload protector will shut off the motor. The motor must be allowed to cool before restarting.

**ON/AUTO - OFF Switch:** Turn this switch ON to provide automatic power to the pressure switch and OFF to remove power at the end of each use.

**Air Intake Filter:** This filter is designed to clean air coming into the pump. This filter **must** always be clean and ventilation openings free from obstructions. See "Maintenance".

**Air Compressor Pump:** To compress air, the piston moves up and down in the cylinder. On the downstroke, air is drawn in through the air intake valves. The exhaust valve remains closed. On the upstroke of the piston, air is compressed. The intake valves close and compressed air is forced out through the exhaust valve, into the outlet tube, through the check valve and into the air tank. Working air is not available until the compressor has raised the air tank pressure above that required at the air outlet.

**Check Valve:** When the air compressor is operating, the check valve is "open", allowing compressed air to enter the air tank. When the air compressor reaches "cut-out" pressure, the check valve "closes", allowing air pressure to remain inside the air tank.

**Pressure Release Valve:** The pressure release valve located on the side of the pressure switch, is designed to automatically release compressed air from the compressor head and the outlet tube when the air compressor reaches "cut-out" pressure

or is shut off. If the air is not released, the motor will try to start, but will be unable to. The pressure release valve allows the motor to restart freely. When the motor stops running, air will be heard escaping from this valve for a few seconds. No air should be heard leaking when the motor is running, or continuous leaking after unit reaches cut-out pressure.

**Pressure Switch:** The pressure switch automatically starts the motor when the air tank pressure drops below the factory set "cut-in" pressure. It stops the motor when the air tank pressure reaches the factory set "cut-out" pressure.

**Safety Valve:** If the pressure switch does not shut off the air compressor at its cut-out pressure setting, the safety valve will protect against high pressure by "popping out" at its factory set pressure (slightly higher than the pressure switch cut-out setting).

**Outlet Pressure Gauge:** The outlet pressure gauge indicates the air pressure available at the outlet side of the regulator. This pressure is controlled by the regulator and is always less or equal to the tank pressure.

**Tank Pressure Gauge:** The tank pressure gauge indicates the reserve air pressure in the tank.

**Regulator:** The air pressure coming from the air tank is controlled by the regulator knob. Turn the knob clockwise to increase pressure and counterclockwise to decrease pressure. To avoid minor readjustment after making a change in pressure setting, always approach the desired pressure from a lower pressure. When reducing from a higher to a lower setting, first reduce to some pressure less than that desired, then bring up to the desired pressure. Depending on the air requirements of each particular accessory, the outlet regulated air pressure may have to be adjusted while you are operating the accessory.

---

## ASSEMBLY (Portable Only)

---

### Items Needed For Assembly

- a 9/16" socket or open end wrench for attaching the wheels.
- a 3/8" open end wrench to tighten handle screws.

### Installing Wheels, Handles, Rubber Foot Strip (not included on some models)

#### **⚠ WARNING**

**THE WHEELS AND HANDLE DO NOT PROVIDE ADEQUATE CLEARANCE, STABILITY OR SUPPORT FOR PULLING THE UNIT UP AND DOWN STAIRS OR STEPS. THE UNIT MUST BE LIFTED, OR PUSHED UP A RAMP.**

On some models, handles are assembled by the manufacturer. If not assembled, use one of the following methods:

#### **Method 1**

Attach the handle to the inside of the compressor saddle by pushing the handle in until the slot in the handle engages with the tabs in the saddle. Pull the handle back and install the two screws, one on each side of the saddle. Tighten securely.

#### **⚠ CAUTION**

**It may be necessary to brace or support one end of the outfit when attaching the wheels, and the rubber foot strip, because the air compressor will have a tendency to tip.**

#### **Method 2**

1. Remove handle from shipping carton. Squeeze cut ends of handle toward each other until ends can be inserted into slots created by machine tabs on top inside edge of baseplate. Lift both sides of handle to baseplate with locking tab inserting into handle hole on left side only. Insert 1/4x1-1/4 self-tapping screws through holes in side of baseplate and into clamping tab holes. Tighten securely. Check to make sure that handle is secure against baseplate.
2. Remove the protective paper strip from the adhesive backed rubber foot strip. Attach the rubber foot strip to the bottom of the air tank leg. Press firmly into place.
3. Install one shoulder bolt and one nut for each wheel using bolt holes provided. Tighten securely. The outfit will sit level if the wheels are properly installed.

# INSTALLATION AND BREAK-IN PROCEDURES

## Location of the Air Compressor

Locate the air compressor in a clean, dry and well ventilated area. The air filter must be kept clear of obstructions which could reduce air flow to the air compressor. The air compressor should be located at least 12" away from the wall or other obstructions that will interfere with the flow of air. The air compressor head and shroud are designed to allow for proper cooling. If humidity is high, an air filter can be installed on the air outlet adapter to remove excessive moisture. Follow the instructions packaged with the air filter for proper installation.

## Air Compressor Anchoring Methods (Stationary Units Only)

### ⚠ WARNING

**EXCESSIVE VIBRATION CAN WEAKEN THE AIR TANK AND CAUSE AN EXPLOSION. THE COMPRESSOR MUST BE PROPERLY MOUNTED AS ILLUSTRATED BELOW.**

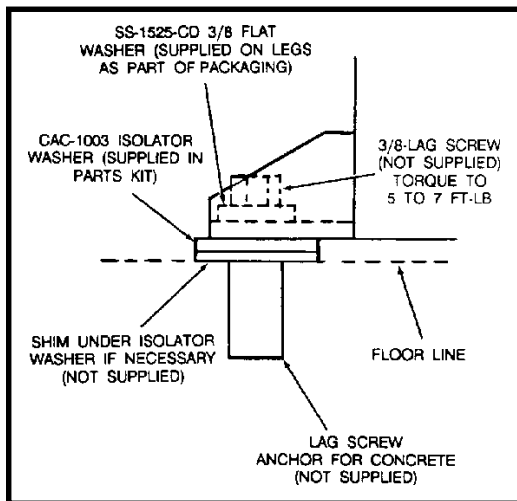

Stationary air compressors must be bolted to the floor. Bolting holes are provided in the base feet. Mount the air compressor on a solid, level foundation. Support compressor weight evenly on all four feet. Solid shims may be used if necessary.

## Lubrication and Oil

This unit needs no lubrication or oiling.

## Extension Cords

To avoid voltage drop, power loss, and overheating to the motor, use extra air hose instead of an extension cord. Low voltage can cause damage to the motor.

If an extension cord *must* be used:

- do not use with any permanently mounted air compressor.
- use only a 3-wire extension cord that has a 3-blade grounding plug and a 3-slot receptacle that will accept the plug on the extension cord.
- make sure the extension cord is in good condition.
- the extension cord should be no longer than 50 feet.
- the minimum wire size is 12 gauge (AWG). (Wire size increases as gauge number decreases. 10 AWG and 8 AWG may also be used. DO NOT USE 14 AWG or 16 AWG.)

### ⚠ CAUTION

**Certain air compressor models can be converted to 240 volts from 120 volt operation. When converting a specific model to 240 volt operation, the attached three-prong 120 volt plug must be replaced with the three-prong 240 volt plug (purchase locally) or order line cord Part No. K-0084.**

**Refer to Parts List of your compressor. Certain air compressor models can be operated on a 15 amp circuit if:**

1. Voltage supply to circuit is normal.
2. Circuit is not used to supply any other electrical needs (lights, appliances, etc.).
3. Extension cords comply with specifications in this manual.
4. Circuit is equipped with a 15 amp circuit breaker or 15 amp time delay fuse. Use a Fusetron Type "T" time delay fuse.

Some models have a dual voltage motor, 120 and 240 volt. They are wired for 120 volt but can be converted to 240 volt operation. Instructions for converting these motors for operation at 240 volt can be found printed on the label attached to the side of the motor.

If any of the above conditions cannot be met, or if operation of the compressor repeatedly causes interruption of the power, it may be necessary to operate it from a 20 amp circuit. It is not necessary to change the cord set.

## Voltage and Circuit Protection

Refer to the specification chart for voltage and circuit protection requirements of your compressor. Use only a fuse or circuit breaker that is the same rating as the branch circuit the air compressor is operated on. If the compressor is connected to a circuit protected by fuses, use only dual element time delay fuses.

## Piping

### ⚠ WARNING

**Plastic or PVC pipe is not designed for use with compressed air. Regardless of its indicated pressure rating, plastic pipe can burst from air pressure. Use only metal pipe for air distribution lines.**

If a pipe line is necessary, use pipe that is the same size as the air tank outlet. Piping that is too small will restrict the flow of air. If piping is over 100 feet long, use the next larger size. Bury underground lines below the frost line and avoid pockets where condensation can gather and freeze. Apply pressure before underground lines are covered to make sure all pipe joints are free of leaks.

It is recommended that a flexible coupling be installed between the air discharge valve outlet and main air distribution line to allow for vibration.

## INSTALLATION AND BREAK-IN PROCEDURES (cont'd)

### GROUNDING INSTRUCTIONS

#### **⚠ DANGER**

**RISK OF ELECTRICAL SHOCK!** In the event of a short circuit, grounding reduces the risk of shock by providing an escape wire for the electric current. This air compressor must be properly grounded.

The air compressor is equipped with a cord having a grounding wire with an appropriate grounding plug. The plug must be used with an outlet that has been installed and grounded in accordance with all local codes and ordinances. The outlet must have the same configuration as the plug. See illustration. **DO NOT USE AN ADAPTER.**

Inspect the plug and cord before each use. Do not use if there are signs of damage.

#### **⚠ DANGER**

**IMPROPER GROUNDING CAN RESULT IN ELECTRICAL SHOCK.**

Do not modify the plug that has been provided. If it does not fit the available outlet, the correct outlet should be installed by a qualified electrician.

If repairing or replacing cord or plug, the grounding wire must be kept separate from the current-carrying wires. Never connect the grounding wire to a flat blade plug terminal. The grounding wire has insulation with an outer surface that is green - with or without yellow stripes.

If these grounding instructions are not completely understood, or if in doubt as to whether the compressor is properly grounded, have the installation checked by a qualified electrician.

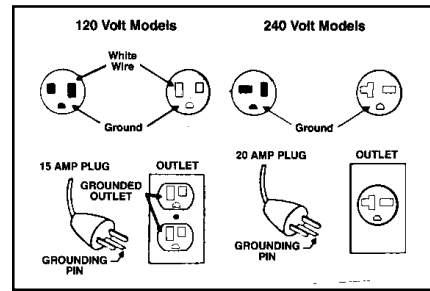

### Additional Regulators and Controls

Since the air tank pressure is usually greater than that which is needed, a separate regulator is usually employed to control the air pressure ahead of any individual air driven device.

### Break-in Procedures

#### **⚠ CAUTION**

**Serious damage may result if the following break-in instructions are not closely followed.**

This procedure is required:

1. Before the air compressor is put into service. (Before the hose is installed.)
2. When the check valve is replaced.
3. When a complete compressor pump is replaced.
  - a. Set the pressure switch lever to the "OFF" position.
  - b. Plug the power cord into the correct branch circuit receptacle.
  - c. Turn the regulator clockwise opening it fully, to prevent air pressure build-up in the tank.
  - d. Move the pressure switch lever to "ON/AUTO". The compressor will start.
  - e. Run the compressor for 15 minutes. Make sure the regulator is open and there is no tank pressure build-up.
  - f. After 15 minutes, close the regulator by turning it counterclockwise. The air receiver will fill to cut-out pressure and the motor will stop. The compressor is now ready for use.

## OPERATING PROCEDURES

### Daily Start-Up Checklist

1. Before attaching air hose or accessories, make sure the ON/AUTO lever is set to "OFF" and the air regulator is closed.
2. Attach hose and accessories.

#### **⚠ WARNING**

**TOO MUCH AIR PRESSURE CAUSES A HAZARDOUS RISK OF BURSTING. CHECK THE MANUFACTURER'S MAXIMUM PRESSURE RATING FOR AIR TOOLS AND ACCESSORIES. THE REGULATOR OUTLET PRESSURE MUST NEVER EXCEED THE MAXIMUM PRESSURE RATING.**

3. Turn the ON/AUTO lever to "AUTO" and allow tank pressure to build. Motor will stop when tank pressure reaches "cut-out" pressure.

4. Open the regulator by turning it clockwise. Adjust the regulator to the correct pressure setting. Your compressor is ready for use.
5. Always operate the air compressor in well-ventilated areas; free of gasoline or other solvent vapors. Do not operate the compressor near the spray area.

### When you are finished:

6. Set the "ON/AUTO" lever to "OFF".
7. Turn the regulator counterclockwise and set the outlet pressure to zero.
8. Remove the air tool or accessory.
9. Open the regulator and allow the air to slowly bleed from the tank. Close the regulator when tank pressure is approximately 20 psi.
10. Drain water from air tank by opening drain cock valve on bottom of tank.



## **⚠ WARNING**

**WATER WILL CONDENSE IN THE AIR TANK. IF NOT DRAINED, WATER WILL CORRODE AND WEAKEN THE AIR TANK CAUSING A RISK OF AIR TANK RUPTURE.**

11. After the water has been drained, close the drain cock or drain valve. The air compressor can now be stored.

### **NOTE**

**If drain cock valve is plugged, release all air pressure. The valve can then be removed, cleaned, then reinstalled.**

## **MAINTENANCE**

### **⚠ DANGER**

**UNIT CYCLES AUTOMATICALLY WHEN POWER IS ON. WHEN DOING MAINTENANCE, YOU MAY BE EXPOSED TO VOLTAGE SOURCES, COMPRESSED AIR OR MOVING PARTS. PERSONAL INJURIES CAN OCCUR. BEFORE PERFORMING ANY MAINTENANCE OR REPAIR, DISCONNECT POWER SOURCE FROM THE COMPRESSOR AND BLEED OFF ALL AIR PRESSURE.**

To ensure efficient operation and longer life of the air compressor outfit, a routine maintenance schedule should be prepared and followed. The following routine maintenance schedule is geared to an outfit in a normal working environment operating on a daily basis. If necessary, the schedule should be modified to suit the conditions under which your compressor is used. The modifications will depend upon the hours of operation and the working environment. Compressor outfits in an extremely dirty and/or hostile environment will require a greater frequency of all maintenance checks.

### **ROUTINE MAINTENANCE SCHEDULE**

#### **Daily:**

1. Drain water from the air tank, any moisture separators or transformers.
2. Check for any unusual noise and/or vibration.
3. Manually check safety valve to make sure of proper operation.
4. Inspect air filter, replace if necessary.

5. Inspect air lines and fittings for leaks; correct as necessary.

#### **Each Year of Operation or if a Problem is Suspected:**

Check condition of air compressor pump intake and exhaust valves. Replace if damaged or worn out.

## **SERVICE INSTRUCTIONS**

### **Air Filter - Inspection and Replacement**

Keep the air filter clean at all times. Do not operate the compressor with the air filter removed. A dirty air filter will not allow the compressor to operate at full capacity. Before you use the compressor, check the air filter to be sure it is clean. If it is dirty, simply pull it out. You may wash it with a mild detergent and warm water, or replace it.

### **Safety Valve - Inspection**

## **⚠ WARNING**

**IF THE SAFETY VALVE DOES NOT WORK PROPERLY, OVER-PRESSURIZATION MAY OCCUR, CAUSING AIR TANK RUPTURE OR AN EXPLOSION. DAILY PULL THE RING ON THE SAFETY VALVE TO MAKE SURE THAT THE SAFETY VALVE OPERATES FREELY. IF THE VALVE IS STUCK OR DOES NOT OPERATE SMOOTHLY, IT MUST BE REPLACED WITH THE SAME TYPE OF VALVE.**

### **Units With External Brass Check Valve Replacement**

1. Release all air pressure from air tank and unplug outfit.
2. Remove shroud (if necessary).
3. Loosen the top and bottom nuts and remove the outlet tube.

4. Remove the pressure release tube and fitting.
5. Unscrew the check valve (turn counterclockwise) using a socket wrench.
6. Check that the valve disc moves freely inside the check valve and that the spring holds the disc in the upper, closed position. The check valve may be cleaned with a strong solvent.
7. Apply sealant to the check valve threads. Reinstall the check valve (turn clockwise).
8. Replace the pressure release tube and fitting.
9. Replace the outlet tube and tighten top and bottom nuts.
10. Replace the shroud (if removed).

### **Motor**

The motor has an automatic reset thermal overload protector. If the motor overheats for any reason, the overload protector will shut off the motor. The motor must be allowed to cool down before restarting. The compressor will automatically restart after the motor cools.

If the overload protector shuts the motor off frequently, check for a possible voltage problem. Low voltage can also be suspected when:

1. The motor does not get up to full power or speed.
2. Fuses blow out when starting the motor; lights dim and remain dim when motor is started and/or is running.

### **Motor - Wiring Diagram**

The motor connection diagram is located on the side of motor.

# STORAGE

- Before you store the air compressor, make sure you do the following:
1. Review the "Maintenance" and "Operating Procedures" sections and perform maintenance as necessary. Be sure to drain water from the air tank.
  2. Protect the electrical cord and air hose from damage (such as being stepped on or run over). Wind them loosely around the compressor handle. (If so equipped)  
Store the air compressor in a clean and dry location.

## TROUBLESHOOTING GUIDE

### ⚠ WARNING

**PERFORMING REPAIRS MAY EXPOSE VOLTAGE SOURCES, MOVING PARTS OR COMPRESSED AIR SOURCES. PERSONAL INJURY MAY OCCUR. PRIOR TO ATTEMPTING ANY REPAIRS, UNPLUG THE COMPRESSOR AND BLEED OFF TANK AIR PRESSURE.**

PROBLEM	CAUSE	CORRECTION
Excessive tank pressure - safety valve pops off.	Pressure switch does not shut off motor when compressor reaches "cut-out" pressure.  Pressure switch "cut-out" too high.	Move the pressure switch lever to the "OFF" position. If the outfit doesn't shut off, unplug. If the electrical contacts are welded together, replace the pressure switch.  Contact an authorized service center to check and replace pressure switch.
Air leaks at fittings.	Tube fittings are not tight enough.	Tighten fittings where air can be heard escaping. Check fittings with soapy water solution. <b>DO NOT OVER-TIGHTEN.</b>
Air leaks at or inside check valve.	Defective or dirty check valve.	A defective check valve results in a constant air leak at the pressure release valve when there is pressure in the tank and the compressor is shut off. Drain tank then remove and clean or replace check valve. <b>DO NOT OVER-TIGHTEN.</b>
Air leaks at pressure switch release valve.	Defective pressure switch release valve.  Defective check valve.	Remove and replace the release valve.  A defective check valve results in a constant air leak at the pressure release valve when there is pressure in the tank and the compressor is shut off. Drain tank then remove and clean or replace check valve. <b>DO NOT OVER-TIGHTEN.</b>
Air leaks in air tank or at air tank welds.	Defective air tank.	<b>⚠ WARNING</b>  <b>DO NOT DRILL INTO, WELD OR OTHERWISE MODIFY AIR TANK OR IT WILL WEAKEN. THE TANK CAN RUPTURE OR EXPLODE. TANK MUST BE REPLACED.</b>
Air leaks between head and valve plate.	Leaking o-ring.	Torque head screws to 8 ft. lbs. If this does not stop leak, replace o-ring.
Pressure reading on the regulated pressure gauge drops when an accessory is used.	It is normal for "some" pressure drop to occur.	If there is an excessive amount of pressure drop when the accessory is used, adjust the regulator following the instructions on page 6.  <b>NOTE:</b> Adjust the regulated pressure under flow conditions (while accessory is being used).
Air leak from safety valve.	Possible defect in safety valve.	Operate safety valve manually by pulling on ring. If valve still leaks, it should be replaced.
Knocking Noise.	Defective check valve.	Remove and clean, or replace.

PROBLEM	CAUSE	CORRECTION
Compressor is not supplying enough air to operate accessories.	<p>Prolonged excessive use of air.</p> <p>Compressor is not large enough for air requirement.</p> <p>Restricted air intake filter.</p> <p>Hole in hose.</p> <p>Check valve restricted.</p> <p>Air leaks.</p>	<p>Decrease amount of air usage.</p> <p>Check the accessory air requirement. If it is higher than the SCFM or pressure supplied by your air compressor, you need a larger compressor.</p> <p>Clean or replace air intake filter. Do not operate the air compressor with the filter removed. See page 9.</p> <p>Check and replace if required.</p> <p>Remove and clean, or replace.</p> <p>Tighten fittings. (See Air Leaks Section of Troubleshooting Guide.)</p>
Motor will not run or restart.	<p>Motor overload protection switch has tripped.</p> <p>Tank pressure exceeds pressure switch “cut-in” pressure.</p> <p>Wrong gauge wire or length of extension cord.</p> <p>Check valve stuck open.</p> <p>Loose electrical connections.</p> <p>Possible defective motor or starting capacitor.</p> <p>Paint spray on internal motor parts.</p> <p>Fuse blown, circuit breaker tripped.</p> <p>Pressure release valve on pressure switch has not unloaded head pressure.</p>	<p>Let motor cool off and overload switch will automatically reset.</p> <p>Motor will start automatically when tank pressure drops below “cut-in” pressure of pressure switch.</p> <p>Check for proper gauge wire and cord length.</p> <p>Remove and clean, or replace.</p> <p>Check wiring connection inside pressure switch and terminal box area.</p> <p>Contact an Authorized Warranty Service Center for inspection or replacement, if necessary.</p> <p>Have checked by an Authorized Warranty Service Center. Do not operate the compressor in the paint spray area. See flammable vapor warning.</p> <ol style="list-style-type: none"> <li>1. Check fuse box for blown fuse and replace, if necessary. Reset circuit breaker. Do not use a fuse or circuit breaker with higher rating than that specified for your particular branch circuit.</li> <li>2. Check for proper fuse; only “Fusetron” type T fuses are acceptable.</li> <li>3. Check for low voltage conditions and/or proper extension cord.</li> <li>4. Disconnect the other electrical appliances from circuit or operate the compressor on its own branch circuit.</li> </ol> <p>Bleed the line by pushing the lever on the pressure switch to the “off” position; if the valve does not open, replace it.</p>
Regulator knob has continuous air leak. Regulator will not shut off air outlet.	Damaged regulator.	Replace regulator.

---

**GENERAL MANUAL FOR  
PERMANENTLY LUBRICATED  
PORTABLE/STATIONARY AIR COMPRESSOR**

---

***SERVICE NOTES***