

# General Manual

## Oil Lubricated Single Stage Stationary Air Compressors

### TABLE OF CONTENTS

<p><b>SAFETY GUIDELINES</b> ..... 1</p> <p><b>WARRANTY STATEMENT</b> ..... 2</p> <p><b>WARNING CHART</b> ..... 3-4</p> <p><b>SPECIFICATIONS</b> ..... 5</p> <p><b>GLOSSARY</b> ..... 5</p> <p><b>DUTY CYCLE</b> ..... 5</p> <p><b>GENERAL INFORMATION</b> ..... 5</p> <p><b>ON-RECEIPT INSPECTION</b> ..... 5</p> <p><b>DESCRIPTION OF OPERATION</b> ..... 6</p> <p><b>INSTALLATION AND BREAK-IN PROCEDURES</b> ..... 6-9</p> <p style="padding-left: 20px;">Location of Air Compressor ..... 6</p> <p style="padding-left: 20px;">Anchoring Methods ..... 6</p> <p style="padding-left: 20px;">Verticle Units ..... 6</p> <p style="padding-left: 20px;">Voltage and Circuit Protection ..... 7</p> <p style="padding-left: 20px;">Lubrication and Oil ..... 7</p> <p style="padding-left: 20px;">Additional Regulators and Controls ..... 7</p> <p style="padding-left: 20px;">Break-in Procedures ..... 7</p> <p style="padding-left: 20px;">Wiring Instruction ..... 7</p> <p style="padding-left: 20px;">Piping ..... 8</p> <p><b>OPERATING PROCEDURES</b> ..... 9-10</p>	<p style="padding-left: 40px;">Daily Start-Up Checklist ..... 9</p> <p style="padding-left: 40px;">Normal Operation ..... 9-10</p> <p><b>MAINTENANCE</b> ..... 10</p> <p style="padding-left: 20px;">Routine Maintenance Schedule ..... 10</p> <p><b>SERVICE INSTRUCTIONS</b> ..... 11-12</p> <p style="padding-left: 20px;">Air Filter - Inspection and Replacement ..... 11</p> <p style="padding-left: 20px;">Oil - Checking and Changing ..... 11</p> <p style="padding-left: 20px;">Check Valve - Inspection and Replacement ..... 11</p> <p style="padding-left: 20px;">Safety Valve - Inspection and Replacement ..... 11</p> <p style="padding-left: 20px;">Belt Replacement ..... 11</p> <p style="padding-left: 20px;">Belt Guard - Removal and Installation ..... 11</p> <p style="padding-left: 20px;">Adjusting Belt Tension ..... 12</p> <p style="padding-left: 20px;">Pressure Switch - Replacement ..... 12</p> <p style="padding-left: 20px;">Motor Overload Protector - Reset ..... 12</p> <p style="padding-left: 20px;">Pulley and Flywheel - Alignment ..... 12</p> <p style="padding-left: 20px;">Servicing Intake and Exhaust Valves ..... 12</p> <p><b>STORAGE</b> ..... 12</p> <p><b>TROUBLESHOOTING GUIDE</b> ..... 13-15</p>
--	--

### SAFETY GUIDELINES - DEFINITIONS

This manual contains information that is important for you to know and understand. This information relates to protecting **YOUR SAFETY** and **PREVENTING EQUIPMENT PROBLEMS**. To help you recognize this information, we use the symbols to the right. Please read the manual and pay attention to these sections.

#### ▲ DANGER

**URGENT SAFETY INFORMATION - A HAZARD THAT WILL CAUSE SERIOUS INJURY OR LOSS OF LIFE.**

#### ▲ CAUTION

Information for preventing damage to equipment.

#### ▲ WARNING

**IMPORTANT SAFETY INFORMATION - A HAZARD THAT MIGHT CAUSE SERIOUS INJURY OR LOSS OF LIFE.**

#### NOTE

Information that you should pay special attention to.

Call our **Toll Free Number 1-800-888-2468, Ext 2**, to obtain the location of the nearest Authorized Service Center for ordering repair parts and for warranty repairs.

When ordering repair parts from your local Authorized Service Center, always give the following information:

- Model number of your product
- Part number and description of the item you wish to purchase

**Retain Original Sales Receipt as Proof of Purchase for Warranty Repair Work.**

## **LIMITED WARRANTY ONE YEAR FROM DATE OF PURCHASE**

All merchandise manufactured by DeVilbiss Air Power Company/ExCell Manufacturing is warranted to be free of defects in workmanship and material which occur during the first year from the date of purchase by the original purchaser (initial user). Products covered under this warranty include: air compressors, \*air tools, accessories, service parts, pressure washers, and generators used in consumer applications (i.e., personal residential household usage only).

Air compressors, \*air tools, accessories, service parts, pressure washers, and generators used in commercial applications (income producing) are covered by a 90 day warranty.

DeVilbiss Air Power/ExCell Manufacturing will repair or replace, at DeVilbiss/ExCell's option, products or components which have failed within the warranty period. Repair or replacement, and service calls on 60 and 80 gallon air compressors, will be handled by Authorized Warranty Service Centers and will be scheduled and serviced according to the normal work flow and business hours at the service center location, and depending on the availability of replacement parts.

All decisions of DeVilbiss Air Power Company/ExCell Manufacturing with regard to this policy shall be final.

This warranty gives you specific legal rights, and you may also have other rights which vary from state to state.

### **RESPONSIBILITY OF ORIGINAL PURCHASER (Initial User):**

- Retain original cash register sales receipt as proof of purchase for warranty work.
- Use reasonable care in the operation and maintenance of the product as described in the Owners Manual(s).
- Deliver or ship the product to the nearest DeVilbiss Air Power/ExCell Manufacturing Authorized Warranty Service Center. Freight costs, if any, must be paid by the purchaser.
- Air compressors with 60 and 80 gallon tanks only will be inspected at the site of installation. Contact the nearest Authorized Warranty Service Center, that provides on-site service calls, for service call arrangement.
- If the purchaser does not receive satisfactory results from the Authorized Warranty Service Center, the purchaser should contact DeVilbiss Air Power Company/ExCell Manufacturing.

### **THIS WARRANTY DOES NOT COVER:**

- Merchandise sold as reconditioned, floor models and/or display models. Any damaged or incomplete equipment sold "as is".
- Merchandise used as "rental" equipment.
- Merchandise that has become inoperative because of ordinary wear, misuse, freeze damage, use of improper chemicals, negligence, accident, improper and/or unauthorized repair or alterations including failure to operate the product in accordance with the instructions provided in the Owners Manual (s) supplied with the product.  
\*Air Tools: O-Rings and driver blades are considered ordinary wear parts, therefore, they are warranted for a period of 45 days from the date of purchase.
- An air compressor that pumps air more than 50% during a one hour period is considered misuse because the air compressor is undersized for the required air demand. Maximum compressor pumping time per hour is 30 minutes.
- Merchandise sold by DeVilbiss Air Power/ExCell Manufacturing which has been manufactured by and identified as the product of another company. The product manufacturer's warranty will apply.
- Repair and transportation costs of merchandise determined not to be defective.
- Cost associated with assembly, required oil, adjustments or other installation and start-up cost.
- ANY INCIDENTAL, INDIRECT OR CONSEQUENTIAL LOSS, DAMAGE, OR EXPENSE THAT MAY RESULT FROM ANY DEFECT, FAILURE OR MALFUNCTION OF THE PRODUCT.** Some states do not allow the exclusion or limitation of incidental or consequential damages, so the above limitation or exclusion may not apply to you.
- IMPLIED WARRANTIES, INCLUDING THOSE OF MERCHANTABILITY AND FITNESS FOR A PARTICULAR PURPOSE, ARE LIMITED TO ONE YEAR FROM THE DATE OF ORIGINAL PURCHASE.** Some states do not allow limitations on how long an implied warranty lasts, so the above limitations may not apply to you.

**DeVILBISS AIR POWER COMPANY**  
213 Industrial Drive • Jackson, TN 38301-9615  
Telephone: 1-800-888-2468, Ext. 2  
FAX: 1-800-888-9036

# IMPORTANT SAFETY INSTRUCTIONS

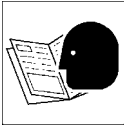

• SAVE THESE INSTRUCTIONS •





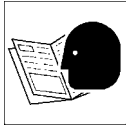

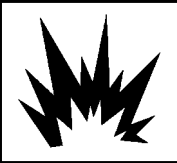
**IMPROPER OPERATION OR MAINTENANCE OF THIS PRODUCT COULD RESULT IN SERIOUS INJURY AND PROPERTY DAMAGE. READ AND UNDERSTAND ALL WARNINGS AND OPERATING INSTRUCTIONS BEFORE USING THIS EQUIPMENT.**

## ⚠ WARNING

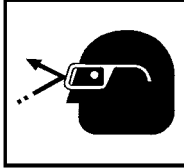

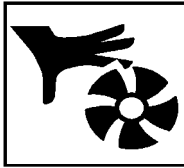
HAZARD	WHAT CAN HAPPEN	HOW TO PREVENT IT
<p><b>RISK OF BURSTING</b></p> 	<p><b>AIR TANK</b></p> <p><b><u>THE FOLLOWING CONDITIONS COULD LEAD TO A WEAKENING OF THE TANK, AND RESULT IN A VIOLENT TANK EXPLOSION:</u></b></p> <ol style="list-style-type: none"> <li><b><u>1. FAILURE TO PROPERLY DRAIN CONDENSED WATER FROM THE TANK, CAUSING RUST AND THINNING OF THE STEEL TANK.</u></b></li> <li><b><u>2. MODIFICATIONS OR ATTEMPTED REPAIRS TO THE TANK.</u></b></li> <li><b><u>3. UNAUTHORIZED MODIFICATIONS TO THE PRESSURE SWITCH, SAFETY VALVE, OR ANY OTHER COMPONENTS WHICH CONTROL TANK PRESSURE.</u></b></li> </ol> <p><b><u>ATTACHMENTS &amp; ACCESSORIES</u></b></p> <p><b><u>EXCEEDING THE PRESSURE RATING OF AIR TOOLS, SPRAY GUNS, AIR OPERATED ACCESSORIES, TIRES AND OTHER INFLATABLES CAN CAUSE THEM TO EXPLODE OR FLY APART, AND COULD RESULT IN SERIOUS INJURY.</u></b></p> <p><b><u>EXCESSIVE VIBRATION CAN WEAKEN THE AIR TANK OF A STATIONARY COMPRESSOR AND CAUSE AN EXPLOSION.</u></b></p>	<p><b><u>DRAIN TANK DAILY OR AFTER EACH USE.</u></b> IF TANK DEVELOPS A LEAK, REPLACE IT IMMEDIATELY WITH A NEW TANK OR NEW COMPRESSOR OUTFIT.</p> <p><b><u>NEVER DRILL INTO, WELD, OR MAKE ANY MODIFICATIONS TO THE TANK OR ITS ATTACHMENTS.</u></b></p> <p>THE TANK IS DESIGNED TO WITHSTAND SPECIFIC OPERATING PRESSURES. <b><u>NEVER MAKE ADJUSTMENTS OR PARTS SUBSTITUTIONS TO ALTER THE FACTORY SET OPERATING PRESSURES.</u></b></p> <p>FOR ESSENTIAL CONTROL OF AIR PRESSURE, YOU MUST <b><u>INSTALL A PRESSURE REGULATOR AND PRESSURE GAUGE TO THE AIR OUTLET</u></b> OF YOUR COMPRESSOR. FOLLOW THE EQUIPMENT MANUFACTURERS RECOMMENDATION AND NEVER EXCEED THE MAXIMUM ALLOWABLE PRESSURE RATING OF ATTACHMENTS. <b><u>NEVER USE COMPRESSOR TO INFLATE SMALL LOW-PRESSURE OBJECTS SUCH AS CHILDREN'S TOYS, FOOTBALLS, BASKETBALLS. ETC.</u></b></p> <p>THE <b><u>COMPRESSOR MUST BE PROPERLY MOUNTED.</u></b> SEE INSTALLATION PROCEDURES.</p>
<p><b>RISK OF EXPLOSION OR FIRE</b></p>  	<p><b><u>IT IS NORMAL FOR ELECTRICAL CONTACTS WITHIN THE MOTOR AND PRESSURE SWITCH TO SPARK.</u></b></p> <p><b><u>IF ELECTRICAL SPARKS FROM COMPRESSOR COME INTO CONTACT WITH FLAMMABLE VAPORS, THEY MAY IGNITE, CAUSING FIRE OR EXPLOSION.</u></b></p> <p><b><u>RESTRICTING ANY OF THE COMPRESSOR VENTILATION OPENINGS WILL CAUSE SERIOUS OVERHEATING AND COULD CAUSE FIRE.</u></b></p>	<p>ALWAYS <b><u>OPERATE THE COMPRESSOR IN A WELL VENTILATED AREA FREE OF COMBUSTIBLE MATERIALS, GASOLINE OR SOLVENT VAPORS.</u></b></p> <p>IF SPRAYING FLAMMABLE MATERIALS, <b><u>LOCATE COMPRESSOR AT LEAST 20 FEET AWAY FROM SPRAY AREA.</u></b> AN ADDITIONAL LENGTH OF HOSE MAY BE REQUIRED.</p> <p><b><u>STORE FLAMMABLE MATERIALS IN A SECURE LOCATION AWAY FROM COMPRESSOR.</u></b></p> <p><b><u>NEVER PLACE OBJECTS AGAINST OR ON TOP OF COMPRESSOR. OPERATE COMPRESSOR IN AN OPEN AREA AT LEAST 12 INCHES AWAY FROM ANY WALL OR OBSTRUCTION THAT WOULD RESTRICT THE FLOW OF FRESH AIR TO THE VENTILATION OPENINGS.</u></b></p>

HAZARD	WHAT CAN HAPPEN	HOW TO PREVENT IT
<p><b>RISK OF ELECTRICAL SHOCK</b></p> 	<p><u>YOUR AIR COMPRESSOR IS POWERED BY ELECTRICITY.</u> LIKE ANY OTHER ELECTRICALLY POWERED DEVICE, <u>IF IT IS NOT USED PROPERLY IT MAY CAUSE ELECTRIC SHOCK.</u></p> <p><u>REPAIRS ATTEMPTED BY UNQUALIFIED PERSONNEL CAN RESULT IN SERIOUS INJURY OR DEATH BY ELECTROCUTION.</u></p> <p>ELECTRICAL GROUNDING: <u>FAILURE TO PROVIDE ADEQUATE GROUNDING TO THIS PRODUCT COULD RESULT IN SERIOUS INJURY OR DEATH FROM ELECTROCUTION.</u> SEE GROUNDING INSTRUCTIONS.</p>	<p>NEVER OPERATE THE COMPRESSOR OUTDOORS WHEN IT IS RAINING OR IN WET CONDITIONS.</p> <p><u>NEVER OPERATE COMPRESSOR WITH COVER COMPONENTS REMOVED OR DAMAGE.</u></p> <p>ANY <u>ELECTRICAL WIRING OR REPAIRS</u> REQUIRED ON THIS PRODUCT <u>SHOULD BE PERFORMED BY AUTHORIZED SERVICE CENTER PERSONNEL</u> IN ACCORDANCE WITH NATIONAL AND LOCAL ELECTRICAL CODES.</p> <p><u>MAKE CERTAIN THAT THE ELECTRICAL CIRCUIT TO WHICH THE COMPRESSOR IS CONNECTED PROVIDES PROPER ELECTRICAL GROUNDING, CORRECT VOLTAGE AND ADEQUATE FUSE PROTECTION.</u></p>
<p><b>RISK FROM FLYING OBJECTS</b></p> 	<p>THE <u>COMPRESSED AIR</u> STREAM CAN CAUSE <u>SOFT TISSUE DAMAGE</u> TO EXPOSED SKIN AND <u>CAN PROPEL</u> DIRT, CHIPS, <u>LOOSE PARTICLES</u> AND SMALL OBJECTS AT <u>HIGH SPEED</u>, RESULTING IN PROPERTY DAMAGE OR PERSONAL INJURY.</p>	<p><u>ALWAYS WEAR ANSI Z87.1 APPROVED SAFETY GLASSES WITH SIDE SHIELDS</u> WHEN USING THE COMPRESSOR.</p> <p><u>NEVER POINT ANY NOZZLE OR SPRAYER TOWARD ANY PART OF THE BODY OR AT OTHER PEOPLE OR ANIMALS.</u></p> <p>ALWAYS <u>TURN OFF THE COMPRESSOR, BLEED PRESSURE FROM THE AIR HOSE AND TANK, AND DISCONNECT FROM POWER SOURCE BEFORE PERFORMING MAINTENANCE OR ATTACHING TOOLS AND ACCESSORIES.</u></p>
<p><b>RISK TO BREATHING</b></p> 	<p>THE <u>COMPRESSED AIR</u> FROM YOUR COMPRESSOR <u>IS NOT SAFE FOR BREATHING!</u> THE AIR STREAM MAY CONTAIN CARBON MONOXIDE, TOXIC VAPORS OR SOLID PARTICLES.</p> <p><u>SPRAYED MATERIALS</u> SUCH AS PAINT, PAINT SOLVENTS, PAINT REMOVER, INSECTICIDES, WEED KILLERS, ETC.. <u>CONTAIN HARMFUL VAPORS</u> AND POISONS.</p>	<p><u>NEVER INHALE AIR FROM THE COMPRESSOR</u> EITHER DIRECTLY OR FROM A BREATHING DEVICE CONNECTED TO THE COMPRESSOR.</p> <p><u>WORK IN AN AREA WITH GOOD CROSS-VENTILATION.</u> READ AND <u>FOLLOW THE SAFETY INSTRUCTIONS</u> PROVIDED ON THE LABEL OR SAFETY DATA SHEETS <u>FOR THE MATERIAL YOU ARE SPRAYING.</u> <u>USE A NIOSH/MSHA APPROVED RESPIRATOR</u> DESIGNED FOR USE WITH YOUR SPECIFIC APPLICATION.</p>
<p><b>RISK FROM MOVING PARTS</b></p> 	<p>THE <u>COMPRESSOR CYCLES AUTOMATICALLY</u> WHEN THE <u>PRESSURE SWITCH IS IN THE ON/AUTO POSITION.</u></p> <p><u>MOVING PARTS CAN CAUSE SERIOUS INJURY</u> OR DAMAGE IF THEY COME INTO CONTACT WITH YOU OR YOUR CLOTHING.</p> <p><u>ATTEMPTING TO OPERATE OR REPAIR COMPRESSOR WITH PROTECTIVE SHROUDS REMOVED CAN EXPOSE YOU TO MOVING PARTS AND ELECTRICAL SHOCK.</u></p>	<p>ALWAYS <u>TURN OFF THE COMPRESSOR, BLEED PRESSURE FROM THE AIR HOSE AND TANK, AND DISCONNECT FROM POWER SOURCE BEFORE PERFORMING MAINTENANCE OR ATTACHING TOOLS AND ACCESSORIES.</u></p> <p><u>DO NOT REMOVE THE PROTECTIVE COVERS</u> FROM THIS PRODUCT. <u>NEVER OPERATE THE COMPRESSOR WITH GUARDS OR COVERS WHICH ARE DAMAGED OR REMOVED.</u></p> <p>ANY <u>REPAIRS</u> REQUIRED ON THIS <u>PRODUCT SHOULD BE PERFORMED BY AUTHORIZED SERVICE CENTER PERSONNEL.</u></p>
<p><b>RISK OF BURNS</b></p> 	<p><u>TOUCHING EXPOSED METAL</u> SUCH AS THE COMPRESSOR HEAD OR OUTLET TUBE <u>CAN RESULT IN SERIOUS BURNS.</u></p>	<p><u>NEVER TOUCH ANY EXPOSED METAL PARTS ON COMPRESSOR</u> DURING OR IMMEDIATELY AFTER OPERATION. <u>COMPRESSOR WILL REMAIN HOT</u> FOR SEVERAL MINUTES AFTER OPERATION.</p> <p>DO NOT REACH AROUND PROTECTIVE SHROUDS OR ATTEMPT MAINTENANCE UNTIL UNIT HAS BEEN ALLOWED TO COOL.</p>

# SPECIFICATIONS

Refer to Outfit Part Listing for the specifications of your compressor. Use only a fuse or circuit breaker that is the same rating as the branch circuit the air compressor is operated on. If the compressor is connected to a circuit protected by fuses, use dual element time delay fuses, as noted in the Outfit Parts Listing.

## ⚠ CAUTION

**Improper electrical installation of this product may void its warranty and your fire insurance. Have circuit wiring performed by qualified personnel such as a licensed electrician who is familiar with the current national electric code and any prevailing local electrical codes.**

# GLOSSARY

**CFM:** Cubic feet per minute.

**SCFM:** Standard cubic feet per minute; a unit of measure of air delivery.

**PSIG:** Pounds per square inch gauge; a unit of measure of pressure.

**ASME:** American Society of Mechanical Engineers; made, tested, inspected and registered to meet the standards of ASME.

California Code: Unit may comply with California Code 462 (L) (2) / (M) (2). Specification/Model label is on the side of the tank on units that comply with California Code.

**To Lock Out Power:** Place a lock on the line power switch so no one else can turn on the power.

**Cut-In Pressure:** While the motor is off, air tank pressure drops as you continue to use your accessory or air tool. When the tank pressure drops to a certain low level the motor will restart automatically. The low pressure at which the motor automatically restarts is called "cut-in pressure."

**Cut-Out Pressure:** When you turn on your air compressor and it begins to run, air pressure in the air tank begins to build. It builds to a certain high pressure before the motor automatically shuts off - protecting your air tank from pressure higher than its capacity. The high pressure at which the motor shuts off is called "cut-out pressure."

# DUTY CYCLE

All DeVilbiss Air Power manufactured air compressors should be operated on not more than a 50% duty cycle. This means an air compressor that pumps air more than 50% of one hour, is

considered misuse, because the air compressor is undersized for the required air demand. Maximum compressor pumping time per hour is 30 minutes.

# GENERAL INFORMATION

You have purchased an air compressor unit consisting of an aluminum 2 cylinder, single-stage air compressor pump (with cast iron sleeves), an air tank, and associated controls and instruments. You will also find a Parts Manual.

Your air compressor can be used for operating paint spray guns, air tools, caulking guns, grease guns, air brushes, sandblasters, inflating tires and plastic toys, or spraying weed killers, insecticides, etc. An air pressure regulator is required for most of these applications.

An air line filter is usually required for removal of moisture and oil vapor in compressed air when a paint spray gun is used.

An in-line lubricator is usually required for air tools to prolong tool life.

Separate air transformers which combine the functions of air regulation and/or moisture and dirt removal should be used where applicable.

A regularly scheduled program of preventive maintenance will help provide the long life that has been designed into your compressor outfit. Before operating or performing any maintenance on your compressor, refer to this manual and your Outfit Parts Manual. To keep your compressor in good working order, refer to these publications often and perform preventive maintenance steps as recommended.

# ON-RECEIPT INSPECTION

Each air compressor outfit is carefully tested and checked before shipment. With improper handling, damage may result in transit and cause problems in compressor operation.

Immediately upon arrival, check equipment for both concealed and visible damages to avoid expenses being incurred to correct such problems. This should be done regardless of any visible signs of

damage to the shipping container. If this product was shipped directly to you, report any damages to carrier and arrange for inspection of goods immediately.

For the location or a listing of the nearest DeVilbiss Air Power Authorized Warranty Service Center, call our toll free number at **1-800-888-2468, Ext. 2.**

# DESCRIPTION OF OPERATION

**Drain Valve:** The drain valve is located at the base of the air tank and is used to drain condensation at the end of each use.

**Motor Thermal Overload Protector:** The electric motor has an automatic thermal overload protector. If the motor overheats for any reason, the thermal overload protector will shut off the motor. The motor must be allowed to cool before restarting.

**ON/AUTO - OFF Switch:** Turn this switch ON to provide automatic power to the pressure switch and OFF to remove power at the end of each use.

**Air Intake Filter:** This filter is designed to clean air coming into the pump. This filter must always be clean and ventilation openings free from obstructions. See "Maintenance".

**Air Compressor Pump:** To compress air, the pistons moves up and down in the cylinder. On the downstroke, air is drawn in through the air intake valves. The exhaust valve remains closed. On the upstroke of the piston, air is compressed. The intake valves close and compressed air is forced out through the exhaust valve, through the outlet tube, through the check valve and into the air tank. Working air is not available until the compressor has raised the air tank pressure above that required at the air outlet.

**Check Valve:** When the air compressor is operating, the check valve is "open", allowing compressed air to enter the air tank. When the air compressor reaches "cut-out" pressure, the check valve "closes", allowing air pressure to remain inside the air tank.

**Pressure Release Valve:** The pressure release valve located on the side of the pressure switch, is designed to automatically release compressed air from the compressor head and the outlet tube when the air compressor reaches "cut-out" pressure or is shut off. If the air is not released, the motor will try to start, but will be unable to. The pressure release valve allows the motor to restart freely. When the motor stops running, air will be heard escaping from the valve for a few seconds. No air should be heard leaking when the motor is running, or continuous leaking after unit reaches cut-out pressure.

**Pressure Switch:** The pressure switch automatically starts the motor when the air tank pressure drops below the factory set "cut-in" pressure. It stops the motor when the air tank pressure reaches the factory set "cut-out" pressure.

**Shut-off Valve:** Turn the knob counterclockwise to open the valve and clockwise to close.

**Safety Valve:** If the pressure switch does not shut off the air compressor at its cut-out pressure setting, the safety valve will protect against high pressure by "popping out" at its factory set pressure (slightly higher than the pressure switch cut-out setting).

**Tank Pressure Gauge:** The tank pressure gauge indicates the reserve air pressure in the tank. On outfits with no pressure regulator, this is also the pressure available at the air outlet.

# INSTALLATION AND BREAK-IN PROCEDURES

## Location of the Air Compressor

### ⚠ WARNING

**THE MANIFOLD ASSEMBLY DOES NOT PROVIDE ADEQUATE STABILITY OR SUPPORT FOR LIFTING THE UNIT. IF THE OUTFIT MUST BE MOVED, USE THE TANK FOR LIFTING.**

Operate the air compressor in a clean, dry and well ventilated area. The air intake filter must be kept clear of obstructions which could reduce air delivery of the air compressor. The air compressor should be located at least 12" away from walls or other obstructions that could interfere with the flow of air through the fan bladed flywheel. The air compressor crankcase and head are designed with fins to provide proper cooling.

The flywheel side of the outfit should be placed toward the wall and protected with a totally enclosed belt guard. In no case should the flywheel be closer than 12 to 18 inches from the wall or other obstruction that will interfere with the flow of air through the fan bladed flywheel. The area should allow space on all sides for air circulation and for ease of normal maintenance. Keep the outfit away from areas which have dirt, vapor, and volatile fumes in the atmosphere which may clog and gum the intake filter and valves, causing inefficient operation.

If humidity is high, an air filter can be installed in line to remove excessive moisture. Closely follow instructions packaged with the filter for proper installation. It must be installed as close as possible to the accessory.

The air compressor should be as near to air outlets as possible in order to avoid long pipe lines. Do not place the air compressor where heat is excessive.

Do not use an extension cord. To avoid voltage drop and power loss to the motor, use extra air hose instead of an extension cord.

## Air Compressor Anchoring Methods

### ⚠ WARNING

**VIBRATION CAN WEAKEN THE AIR TANK AND CAUSE AN EXPLOSION. THE COMPRESSOR MUST BE PROPERLY MOUNTED AS ILLUSTRATED BELOW.**

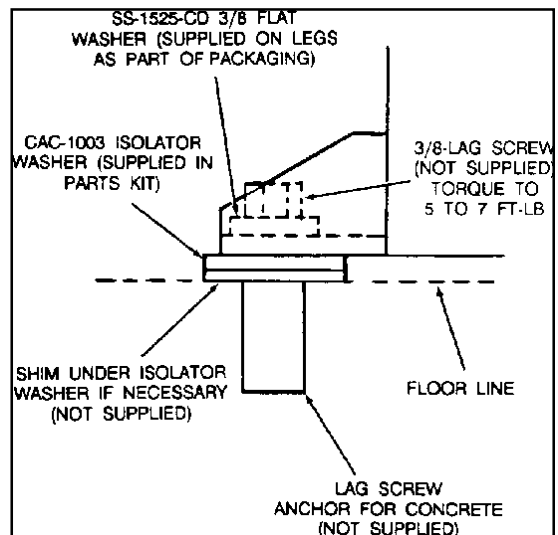

**Anchoring of Vertical Unit**

## Vertical Units

This compressor should be permanently mounted in place on a level floor. Vertical air compressors must be bolted to the floor. Bolting holes are provided in the base feet. Mount the air compressor on a solid, level foundation. Support compressor weight evenly on all four feet. Solid shims may be used if necessary.

## Voltage and Circuit Protection

Refer to your Outfit Parts Manual for the voltage and circuit protection requirements of your compressor. Use only a fuse or circuit breaker that is the same rating as the branch circuit the air compressor is operated on. If the compressor is connected to a circuit protected by fuses, use only dual element time delay fuses, as noted in that Outfit Parts Manual.

## Lubrication and Oil

### ⚠ CAUTION

**Multi-Viscosity motor oils, like 10W 30, should not be used in an air compressor. They leave carbon deposits on critical components, thus reducing performance and compressor life. Use air compressor oil only.**

# INSTALLATION AND BREAK-IN PROCEDURES (cont'd)

### ⚠ CAUTION

**Compressors are shipped without oil. A small amount of oil may be present in the pump upon receipt of the air compressor. This is due to plant testing and does not mean that the pump contains the correct amount of oil. Do not attempt to operate this air compressor without first adding oil to the crankcase. Serious damage can result from even limited operation unless filled with oil and broken in correctly. Make sure to closely follow initial start-up procedures.**

Place unit on a level surface. Remove oil fill plug and slowly add a compressor oil such as Castrol Heavy Duty 30 weight until it is even with the top of the oil fill hole. (It must not be allowed to be lower than 3/8" -- 6 threads down -- from the top at any time.) When filling the crankcase, the oil flows very slowly into the pump. If the oil is added too quickly, it will overflow and appear to be full. **Crankcase oil capacity is 16 fluid ounces.** Replace oil fill plug and tighten.

### NOTE

**Drain and refill the compressor pump crankcase after the first 100 hours of operation.**

## Additional Regulators and Controls

Since the air tank pressure is usually greater than that which is needed, a separate regulator is usually employed to control the air pressure ahead of any individual air driven device.

Separate air transformers which combine the function of air regulation, moisture and dirt removal should be used where applicable.

## Break-in Procedures

### ⚠ CAUTION

**Serious damage may result if the following break-in instructions are not closely followed.**

***This procedure is required:***

1. Before the air compressor is put into service.
2. When the check valve is replaced.
3. When a complete compressor pump is replaced.
  - a. Set the pressure switch lever to the "OFF" position.
  - b. Connect compressor to power source. (See Wiring Instructions).
  - c. Turn the regulator clockwise (or open the shut-off valve), opening it fully, to prevent air pressure build-up in the tank.
  - d. Move the pressure switch lever to "ON/AUTO". The compressor will start.

- e. Run the compressor for 30 minutes. Make sure the regulator, or shut-off valve, is open and there is no tank pressure build-up during this time.
- f. After 30 minutes, close the regulator by turning it counterclockwise or close the shut-off valve by turning the knob clockwise. The air receiver will fill to cut-out pressure and the motor will stop. The compressor is now ready for use.

## Wiring Instructions

Perform electrical wiring according to the following instructions:

### ⚠ WARNING

**IMPROPER ELECTRICAL GROUNDING CAN RESULT IN A RISK OF ELECTRICAL SHOCK. WIRING FOR THE PRESSURE SWITCH AND ELECTRICAL MOTOR SHOULD BE DONE BY A LICENSED ELECTRICIAN IN ACCORDANCE WITH NATIONAL AND LOCAL CODES AND ORDINANCES.**

Install the compressor outfit as close to the main power supply as possible. This practice will avoid using long lengths of electrical wiring for the power supply which can cause power loss and damage to the motor. When connecting wires make sure that:

1. The amperage rating of the electrical box is adequate. Refer to the Specification Chart in the Outfit Parts Manual for your air compressor outfit.
2. The supply line has the same electrical characteristics (voltage, cycle, and phase) as motor.

Wiring must be such that full motor nameplate voltage plus or minus 10%, is available at the motor terminals during starting. Refer to local codes for recommended wire sizes and maximum wire run; under-sized wire causes high amp draw and overheating to the motor.

### ⚠ CAUTION

**Electrical wiring must be located away from hot surfaces such as the compressor head, compressor cylinder, or compressor outlet tube.**

### ⚠ CAUTION

**Improper electrical installation of this product may void its warranty and your fire insurance. Have circuit wiring performed by qualified personnel such as a licensed electrician who is familiar with the current national electric code and any prevailing local electrical codes.**

# INSTALLATION AND BREAK-IN PROCEDURES (cont'd)

Typical schematic subject to all changes as dictated by local electrical codes and authorities.

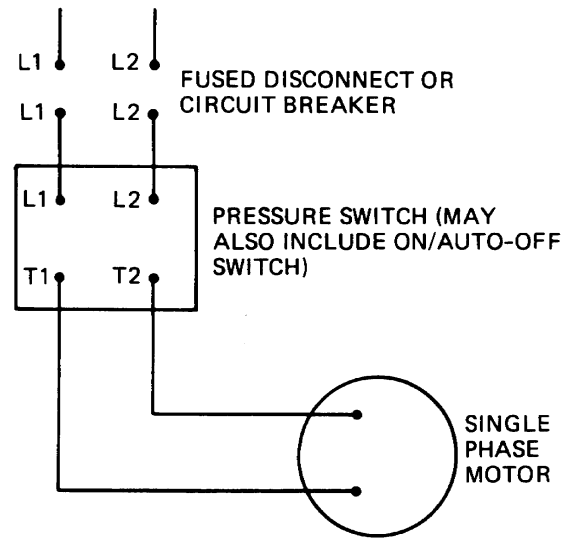
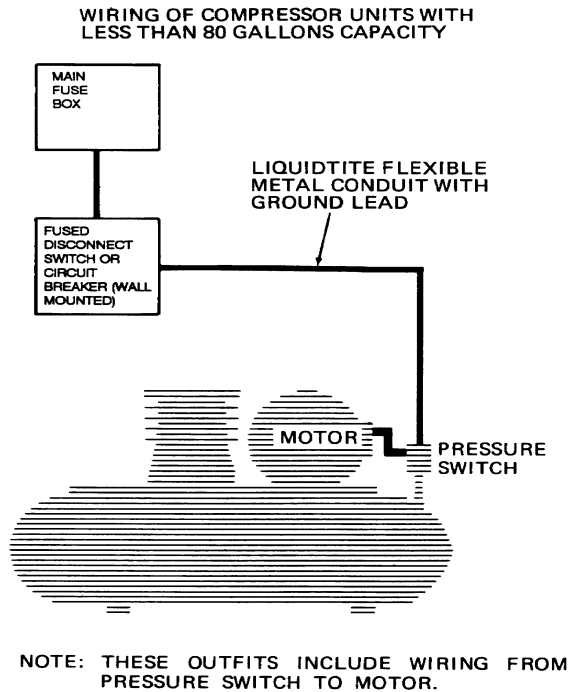

## Wiring of Compressor Units

### Piping

#### CAUTION

Plastic or PVC pipe is not designed for use with compressed air. Regardless of its indicated pressure rating, plastic pipe can burst from air pressure. Use only metal pipe for air distribution lines.

#### Note

Where a remote air intake is used, enlarge the size of the air intake piping by one pipe size for each 10 feet of length.

A typical compressed air distribution system below should be of sufficient pipe size to keep the pressure drop between the supply and point of use to a minimum. All pipes and fittings used must be certified safe for the pressures involved. Pipe thread lubricant must be used on all threads, and all joints are to be made up tight, since small leaks in the piping system are the largest single cause of high operating costs.

All piping should be sloped to an accessible drain point and all outlets should be taken from the top of the main distribution air line so that moisture cannot enter the outlet.

The main distribution air line should not be smaller than the compressor air discharge valve outlet. A smaller line will restrict the flow of air. If piping is over 100 feet long, or if required air flow will exceed 15 SCFM, use 3/4" piping.

It is recommended that a flexible coupling be installed between the air discharge valve outlet and main air distribution line to allow for vibration.

To remove dirt, oil and water, install a separator in the main distribution line. Install separator 5 to 6 feet from compressor to allow the air to cool to room temperature before passing through the separator. Additional separators or filters may be used depending on the application.

#### Note

For underground installation, bury air lines below the frost line and avoid pockets where condensation can gather and freeze. Apply pressure before underground lines are covered to make sure all pipe joints are free from leaks.



# INSTALLATION AND BREAK-IN PROCEDURES (cont'd)

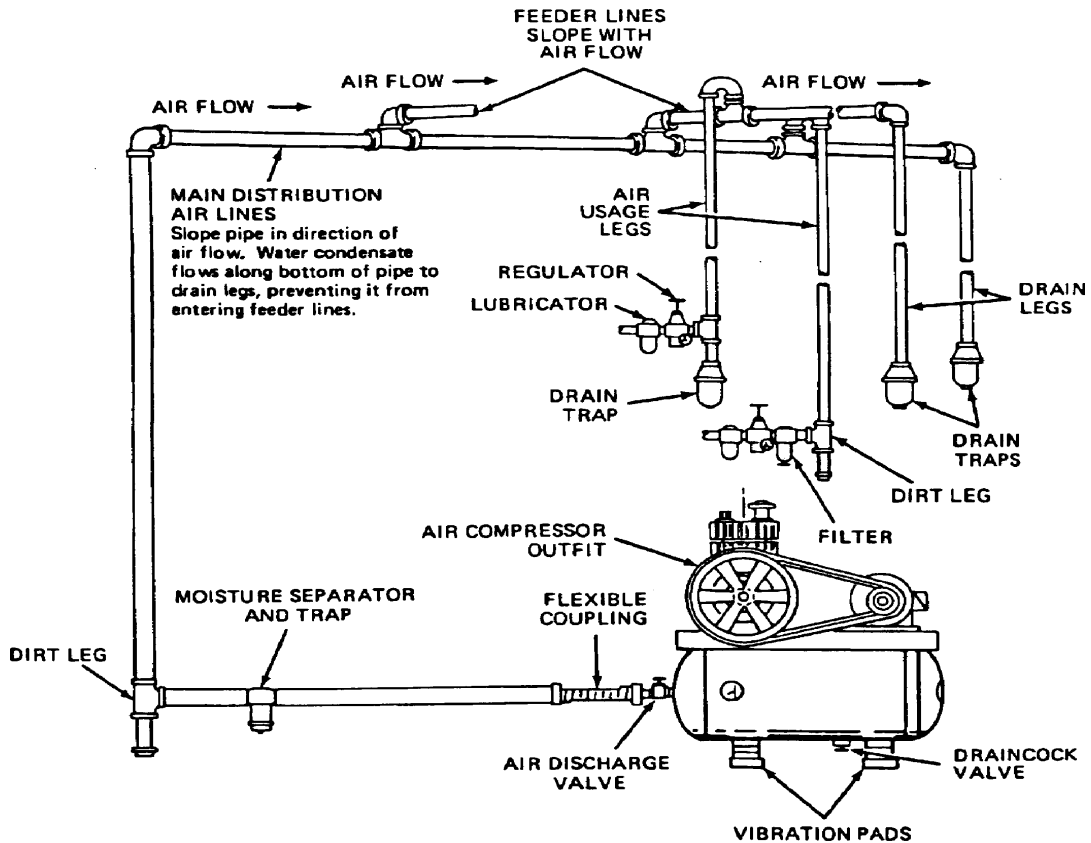

Typical Compressed Air Distribution System

## OPERATING PROCEDURES

### Daily Start-Up Checklist

Perform the following checks before starting the compressor outfit.

1. Make sure that nothing is blocking the belt guard air openings or air filter opening.
2. Pull the ring on all safety valves to make sure the valves move freely and smoothly.
3. Check the oil level; add oil if necessary.
4. Clean or blow off fins or any part of compressor that collects dust and dirt. Compressor will run cooler and provide longer service.

Start the compressor outfit and check the following:

1. With the outlet valve closed, start the compressor outfit. Allow the outfit to pump up to cut-off pressure.
2. Make sure that all controls are operating correctly. Refer to "Description of Operation" section of this manual.
3. Check all line fittings and piping for air leaks. Even minor leaks can cause the compressor to over work, resulting in premature breakdown or unsatisfactory performance.
4. Check for any unusual vibration and noise.
5. Check for oil leaks. Correct any leaks found.

### CAUTION

Compressed air from the outfit may contain water condensation and oil mist. Do not spray unfiltered air at an item that could be damaged by moisture or oil mist. Some air operated tools or devices may require filtered air. Read instructions for the air tool or device.

6. Open shut-off valve. Your outfit is ready for use.

When You Are Finished:

7. Set the pressure switch lever to "OFF".
8. Close the shut-off valve.
9. Remove the air tool or accessory.
10. Open the shut-off valve and allow the air to slowly bleed from the tank. Close shut-off valve when tank pressure is approximately 20 PSI.

### Normal Operation

1. Before attaching an air hose or accessory, make sure the pressure switch lever is in the "OFF" position. Close the shut-off valve by turning the knob clockwise, or close air regulator outlet by turning it counterclockwise.
2. Attach hose and accessory.

# OPERATING PROCEDURES (cont'd)

## Normal Operation (cont'd)

### **⚠ WARNING**

TOO MUCH AIR PRESSURE CAUSES A HAZARDOUS RISK OF BURSTING. CHECK THE MANUFACTURER'S MAXIMUM PRESSURE RATING FOR AIR TOOLS AND ACCESSORIES. THE REGULATOR OUTLET PRESSURE MUST NEVER EXCEED THE MAXIMUM PRESSURE RATING. ON MODELS HAVING ONLY A SHUT-OFF VALVE, YOU MUST INSTALL A REGULATOR BEFORE USING ACCESSORIES RATED AT LESS THAN 125 PSIG.

3. Turn the pressure switch lever to the "ON-AUTO" position and allow tank pressure to build. The motor will stop when tank pressure reaches cut-out pressure. Slowly release air pressure from globe valve.
4. The compressor is now ready for use.

5. **When You Are Finished:** drain tank pressure at approximately 20 PSI, open the drain valve and allow moisture to drain.

### **⚠ WARNING**

DRAIN TANK DAILY. WATER WILL CONDENSE IN THE AIR TANK. IF NOT DRAINED, WATER WILL CORRODE AND WEAKEN AIR TANK, CAUSING A RISK OF AIR TANK RUPTURE.

### **NOTE**

If the drain cock valve is plugged, release all air pressure. The valve can then be removed, cleaned and reinstalled.

6. After the water has been drained, close the drain cock. The air compressor can now be stored.

## MAINTENANCE

### **⚠ DANGER**

UNIT CYCLES AUTOMATICALLY WHEN POWER IS ON. DURING MAINTENANCE, YOU COULD BE EXPOSED TO VOLTAGE SOURCES, COMPRESSED AIR OR MOVING PARTS. PERSONAL INJURIES CAN OCCUR. UNPLUG THE UNIT AND BLEED OFF ALL AIR TANK PRESSURE BEFORE DOING ANY MAINTENANCE OR REPAIR. NEVER OPERATE THE UNIT WITH THE BELT GUARD REMOVED.

To ensure efficient operation and longer life of the air compressor outfit, a routine maintenance schedule should be prepared and followed. The following routine maintenance schedule is geared to an outfit in a normal working environment operating on a daily basis. If necessary, the schedule should be modified to suit the conditions under which your compressor is used. The modifications will depend upon the hours of operation and the working environment. Compressor outfits in an extremely dirty and/or hostile environment will require a greater frequency of all maintenance checks.

## Routine Maintenance Schedule

### **Daily:**

1. Check oil level. Add if necessary.
2. Drain water from the air tank, any moisture separators or transformers.
3. Check for any unusual noise and/or vibration.
4. Manually check all safety valves to make sure they are operating properly.
5. Inspect for oil leaks and repair any leaks found.
6. Inspect air filter, replace if necessary.

### **Every 40 Hours of Operation:**

1. Inspect condition of drive belt; replace if necessary

### **Every 100 Hours of Operation:**

1. Drain and refill compressor crankcase with 16 fluid ounces (473.2 ml) of clean compressor oil such as Castrol Heavy Duty 30 weight.

2. Increase frequency of oil changes if humidity or operating conditions are extreme.

### **Every 160 Hours of Operation:**

1. Check drive belt tension; adjust if necessary. (Refer to SERVICE INSTRUCTIONS in this manual.)
2. Inspect air lines and fittings for leaks; correct as necessary.
3. Check the alignment of the motor pulley to the flywheel. If necessary, align to within 1/32 inch on center line.

### **Each Year of Operation or if a Problem is Suspected:**

Check condition of air compressor pump intake and exhaust valves. Replace if damaged or worn out.

# SERVICE INSTRUCTIONS

## Air Filter - Inspection and Replacement

### ⚠ CAUTION

Keep the air filter clean at all times. Do not operate the compressor with the air filter removed.

A dirty air filter will not allow the compressor to operate at full capacity. Before you use the compressor, check the air filter to be sure it is clean and in place.

If it is dirty, replace it with a new filter. On some models, the filter may be removed by using a pair of needle nosed pliers or a screwdriver. Pull or pry out the old filter. Push in the new air filter. Other models require removal of the filter retainer.

## Oil - Checking and Changing

### ⚠ CAUTION

Overfilling with oil will cause premature compressor failure. Do not overfill.

**Check oil level in the crankcase daily.** Remove the oil fill plug. The oil level should be even with the top of the fill hole and must not be allowed to be lower than 3/8" from the top (6 threads) at any time. It is recommended that the oil be changed after every 100 hours of operation. To drain the oil, remove the oil drain plug and collect the oil in a suitable container. Be sure to replace the plug securely before adding new oil. Use a compressor oil such as Castrol Heavy Duty 30 weight. Crankcase oil capacity is 16 fluid ounces (473.2 ml).

## Check Valve - Inspection and Replacement

Remove and inspect the check valve at least once a year or more often if the compressor is heavily used. Moisture and other contaminants in the hot compressed air will cause an accumulation of a carbon-like residue on the working parts. If the valve has heavy carbon build-up, it should be replaced. Use the following procedure to inspect, clean or replace the check valve.

1. Remove and lock out power from the compressor. Release any air pressure from the air tank.
2. Loosen the top and bottom outlet tube nuts and remove the outlet tube. (Refer to your Parts Manual for parts identification)
3. Unscrew the check valve (turn counterclockwise) using socket wrench (7/8").
4. Check that the valve disc moves freely and that the spring holds the disc in the upper, closed position. The check valve may be cleaned with a solvent.
5. Apply sealant to the check valve threads. Reinstall the check valve (turn clockwise). **DO NOT OVERTIGHTEN.**
6. Replace the outlet tube and tighten top and bottom tube nuts. **DO NOT OVERTIGHTEN.**

## Safety Valve - Inspection and Replacement

### ⚠ WARNING

IF THE SAFETY VALVE DOES NOT WORK PROPERLY, OVER-PRESSURIZATION MAY OCCUR CAUSING AIR TANK RUPTURE OR EXPLOSION. DAILY PULL THE RING ON THE SAFETY VALVE TO MAKE SURE THAT THE SAFETY VALVE OPERATES FREELY. IF THE VALVE IS STUCK OR DOES NOT OPERATE SMOOTHLY, IT MUST BE REPLACED WITH A VALVE HAVING THE SAME PRESSURE RATING.

1. Remove and lock out power from the compressor. Release any air pressure from the air tank.
2. Remove safety valve and replace with valve of the same pressure rating.
3. Apply thread sealant to new safety valve and tighten. **DO NOT OVERTIGHTEN.**

## Belt - Replacement

### ⚠ WARNING

SERIOUS INJURY OR DAMAGE MAY OCCUR IF PARTS OF THE BODY OR LOOSE ITEMS GET CAUGHT IN MOVING PARTS. NEVER OPERATE THE OUTFIT WITH THE BELT GUARD REMOVED. THE BELT GUARD SHOULD BE REMOVED ONLY WHEN THE COMPRESSOR IS UNPLUGGED.

1. Remove and lock out power from the compressor.
2. Remove beltguard screws and beltguard.
3. Remove belt and replace.

### NOTE

The belt must be centered over the grooves on the flywheel and motor pulley.

4. To reinstall beltguard, align the bottom tabs of the beltguard into the slots of the base. These are located behind the ON/OFF switch. Replace beltguard screws and tighten securely.

## Belt Guard - Removal and Installation

Remove and lock out power from the compressor. Release any air pressure from the air tank. Remove and lock out power from the compressor. Release any air pressure from the air tank.

1. Move the "ON/AUTO-OFF" lever to the "OFF" position. Remove and lock out power from the compressor. Release all air tank pressure.
2. Remove the beltguard screws and remove beltguard.
3. To reinstall beltguard, align the bottom tabs of the beltguard into the slots of the base. These are located behind the ON/OFF switch. Replace beltguard screws and tighten securely.

# SERVICE INSTRUCTIONS (cont'd)

## Adjusting Belt Tension

1. Remove and lock out power from the compressor. Release any air pressure from the air tank.
2. Loosen the four screws from the beltguard. Remove beltguard.
3. Remove belt.
4. Loosen motor mounting bolts and slide motor to achieve correct belt tension.
5. Tighten motor mount bolts to 10-20 ft./lbs. and replace belt.
6. Check for proper tension by applying three pounds of pressure midway between the motor pulley and the beltwheel. The belt is properly tensioned when it deflects approximately 1/4" at this point.
7. Ensure beltwheel and motor pulley are aligned.
8. Replace beltguard.

## Pressure Switch - Replacement

### **⚠ WARNING**

**PRESSURE LOADS BEYOND DESIGN LIMITS MAY CAUSE TANK RUPTURE OR EXPLOSION. PRESSURE SWITCH OPERATION IS RELATED TO MOTOR HP, TANK RATING AND SAFETY VALVE SETTING. DO NOT ATTEMPT TO ADJUST, REMOVE OR DEFEAT THE PRESSURE SWITCH, OR CHANGE AND MODIFY ANY PRESSURE CONTROL RELATED DEVICE. IF REPLACEMENT IS NECESSARY, THE SAME RATED SWITCH MUST BE USED. CONTACT A DEVILBISS AIR POWER AUTHORIZED SERVICE CENTER FOR REPLACEMENT.**

## Motor Overload Protector - Reset

The motor has a manual thermal overload protector. If the motor overheats for any reason, the overload protector will shut off the motor. The motor must be allowed to cool down before restarting. Turn the unit off. To restart, depress the red reset button located on the end of the motor and turn ON/AUTO-OFF switch to the ON position.

### **NOTE**

**If the overload protector shuts the motor off frequently, check for a possible voltage problem. Low voltage can also be suspected when:**

1. **The motor does not get up to full power or speed.**
2. **Fuses blow out when the motor is started.**
3. **Lights dim when motor is started, and remain dim while it is running.**

## Pulley and Flywheel - Alignment

The compressor flywheel and motor pulley grooves must be aligned

within 1/32". To check alignment, remove and lock out power from the compressor. Remove beltguard. Place a straight edge (such as a ruler) against the outside of the flywheel and measure the distance from it to the nearest groove. Alignment is achieved when the other end of the straight edge is within 1/32" of the measured dimension at the pulley grooves. If the pulleys are not aligned, loosen the motor pulley set screw. Slide pulley until alignment is achieved. Tighten pulley set screw to 70-80 inch pounds. Replace beltguard and tighten beltguard screws securely.

## Servicing Intake and Exhaust Valves

1. Remove and lock out power from compressor and relieve all air pressure from the air tank.
2. Remove belt guard as noted in "Belt Guard - Removal and Installation" in this manual.
3. Remove the air filter assembly.
4. Disconnect the pressure release and outlet tubes from the air compressor.
5. Remove the hardware securing the cylinder head and remove the cylinder head and valve plate.

### **⚠ WARNING**

**MANY SOLVENTS ARE HIGHLY FLAMMABLE AND A HEALTH HAZARD IF INHALED. ALWAYS OBSERVE THE SOLVENT MANUFACTURER'S SAFETY INSTRUCTIONS AND WARNINGS.**

6. Clean carbon deposits in head cavities and valve plates with lacquer thinner or other suitable solvent.
7. Clean the intake and exhaust valves with lacquer thinner or other suitable solvent. Inspect valves; replace if necessary.

### **NOTE**

**Do not use gasket cement on any gasket surface as this may clog compressor valve cavities and air flow areas.**

8. Reinstall valve plate and gaskets.
9. Install the cylinder head. Snug mounting screws and studs tight, then torque to 25 to 30 foot pounds starting at the center and working toward the outside.
10. Reconnect the pressure release and outlet tubes to the compressor pump.
11. Replace air filter assembly.

# STORAGE OF COMPRESSOR OUTFIT

1. Review the "Maintenance" section on the preceding pages and perform scheduled maintenance as necessary. Drain the water from the air tank.
2. Set the ON/AUTO-OFF switch to the "OFF" position, and remove and lockout power from the unit.
3. Remove any air tool or accessory.
4. Protect the electrical cord and air hose from damage (such as being stepped on or run over).
5. Store the compressor in a clean and dry location.

# TROUBLESHOOTING GUIDE

## ⚠ WARNING

**PERFORMING REPAIRS MAY EXPOSE VOLTAGE SOURCES, MOVING PARTS OR COMPRESSED AIR SOURCES. PERSONAL INJURY MAY OCCUR. PRIOR TO ATTEMPTING ANY REPAIRS, UNPLUG THE COMPRESSOR AND BLEED OFF ALL TANK AIR PRESSURE.**

PROBLEM	CAUSE	CORRECTION
Excessive tank pressure - safety valve pops off.	Pressure switch does not shut off motor when compressor reaches "cut-out" pressure.  Pressure switch "cut-out" too high.	Move the pressure switch lever to the "OFF" position. If the outfit doesn't shut off, and the electrical contacts are welded together, replace the pressure switch.  Return the outfit to an Authorized Warranty Service Center to check, remove or replace switch.
Air leaks at fittings.	Tube fittings are not tight enough.	Tighten fittings where air can be heard escaping. Check fittings with soapy water solution. <b>DO NOT OVER-TIGHTEN.</b>
Defective or dirty check valve.	Air leaks at or inside check valve.	A defective check valve results in a constant air leak at the pressure release valve when there is pressure in the tank and the compressor is shut off. Remove and clean or replace check valve. <b>DO NOT OVER-TIGHTEN. (See page 11)</b>
Air leaks continuously at pressure switch release valve.	Defective pressure switch release valve. Defective check valve.	Remove and replace the release valve.  A defective check valve results in a constant air leak at the pressure release valve when there is pressure in the tank and the compressor is shut off. Remove and clean or replace check valve. <b>DO NOT OVER-TIGHTEN. (See page 11)</b>
Air leaks in air tank or at air tank welds.	Defective air tank.	Air tank must be replaced. Do not repair the leak.  <b>⚠ WARNING</b> <b>DO NOT DRILL INTO, WELD OR OTHERWISE MODIFY AIR TANK OR IT WILL WEAKEN. THE TANK CAN RUPTURE OR EXPLODE.</b>
Air leak from safety valve.  Knocking noise.	Possible defect in safety valve.  Restricted or defective check valve. Loose pulley. Low oil level. Loose flywheel. Loose compressor mounting screws.  Loose belt. Carbon build-up.  Belt too tight.	Operate safety valve manually by pulling on ring. If valve still leaks, it must be replaced with a valve of the same rating.  Remove and clean or replace. Tighten pulley set screw, 70-80 in.-lbs. Maintain prescribed oil level. Add oil. Tighten screw 15-20 ft. lbs. Check screws. Tighten as required. (15-20 ft.-lbs.)  See "Adjusting Belt Tension" on page 12.  Remove the head and valve plate. Clean the valve plate and top of the piston. (Be sure carbon does not fall into the cylinder.) Reassemble to 25-30 ft. lbs. using new gasket and torque screws.  Adjust belt tension (See page 12).

PROBLEM	CAUSE	CORRECTION
Motor will not run.	<p>Motor overload protection switch has tripped.</p> <p>Possible defective starting capacitor.</p> <p>Possible defective motor.</p> <p>Tank pressure exceeds pressure switch "cut-in" pressure.</p> <p>Check valve stuck open - fails to relieve head pressure; motor cannot start.</p> <p>Loose electrical connections.</p> <p>Fuse blown, circuit breaker tripped.</p> <p>Pressure release valve on pressure switch has not unloaded head pressure.</p> <p>Paint spray on internal motor parts.</p>	<p>Let the motor cool off and reset switch by pressing the red button located on the end of the motor. If the overload still trips, check for defective capacitor.</p> <p>Contact Authorized Warranty Service Center for inspection or replacement if necessary.</p> <p>Have checked by a local Authorized Warranty Service Center.</p> <p>Motor will start automatically when tank pressure drops below "cut-in" pressure of pressure switch.</p> <p>Remove and clean, or replace. <b>DO NOT OVER-TIGHTEN.</b> (See page 11)</p> <p>Check wiring connection inside pressure switch and motor terminal box area.</p> <ol style="list-style-type: none"> <li>1. Check fuse box for blown fuse and replace if necessary. Reset circuit breaker. Do not use a fuse or circuit breaker with higher rating than that specified for your particular branch circuit.</li> <li>2. Check for proper fuse; only Buss "Fusetron" Type T fuses are acceptable.</li> <li>3. Check for low voltage conditions.</li> <li>4. Remove check valve and clean or replace if it is stuck open or closed. (See page 11)</li> <li>5. Disconnect any other electrical appliances from circuit. The compressor must operate on its own branch circuit.</li> <li>6. Do not use an extension cord.</li> </ol> <p>Bleed the line by pushing the lever on the pressure switch to the OFF position, opening the pressure release valve. If the valve still doesn't open, it must be replaced.</p> <p>Have checked by an Authorized Warranty Service Center. Do not operate the compressor in the spray area. See Flammable Vapor Warning.</p>
Restricted air intake.	Dirty air filter.	Replace filter.
Compressor is not supplying enough air to operate accessories.	<p>Prolonged excessive use of air.</p> <p>Compressor is not large enough for air requirement.</p> <p>Restricted air intake filter.</p> <p>Loose belt.</p> <p>Hole in hose.</p> <p>Check valve restricted.</p> <p>Air leaks.</p>	<p>Decrease amount of air usage.</p> <p>Check the accessory air requirement. If it is higher than the CFM, SCFM or pressure supplied by your air compressor, you need a larger compressor.</p> <p>Clean or replace air intake filter. Do not operate the compressor in the paint spray area.</p> <p>Adjust belt tension. (See page 12)</p> <p>Check and replace if required.</p> <p>Remove and clean or replace. (See page 11)</p> <p>Tighten fittings. (See "Air Leaks" section of "Troubleshooting Guide".)</p>

<b>PROBLEM</b>	<b>CAUSE</b>	<b>CORRECTION</b>
Excessive belt wear.	Loose belt.  Tight belt.  Loose pulley.  Pulley misalignment.	Adjust tension per instructions. (See "Belt Adjustment or Replacement" page 12) Adjust tension. (See "Belt Adjustment" section on page 12.) Check for worn keyway or pulley bore. Also check for bent motor shaft. Replace parts if necessary. Motor pulley and flywheel must be in line within 1/32". (See "Pulley and Flywheel - Alignment" section on page 12.)
Squealing sound.	Loose belt.  There is no oil in the compressor.	Adjust belt tension. (See "Belt Replacement" section on page 12.) Add oil to top of fill hole in base.
Pressure reading on the regulated pressure gauge drops when an accessory is used.	It is normal for "some" pressure drop to occur.	If there is an excessive amount of pressure drop when the accessory is used, adjust the regulator.  <b>NOTE</b> <b>Adjust the regulated pressure under flow conditions (while the accessory is being used).</b>
Motor overheating	Incorrect oil, low oil.  Low voltage  Pressure switch set beyond factory setting.  Belt too tight.  Compressor valves have excessive carbon deposits build-up; restricted check valve.	See oil recommendation on page 11.  Proper correct voltage. Consult local power company or electrician. Do not set switch beyond maximum for which outfit was designed as noted on nameplate. Adjust for proper tension. (See page 12) Clean or replace compressor valves or check valves.

**General Manual**  
**Oil Lubricated Single Stage Stationary**  
**Air Compressors**

**SERVICE RECORD**