

ESPAÑOL: PÁGINA 17
FRANÇAISE : PAGE 35

Instruction manual

Double Insulated Circular Saw

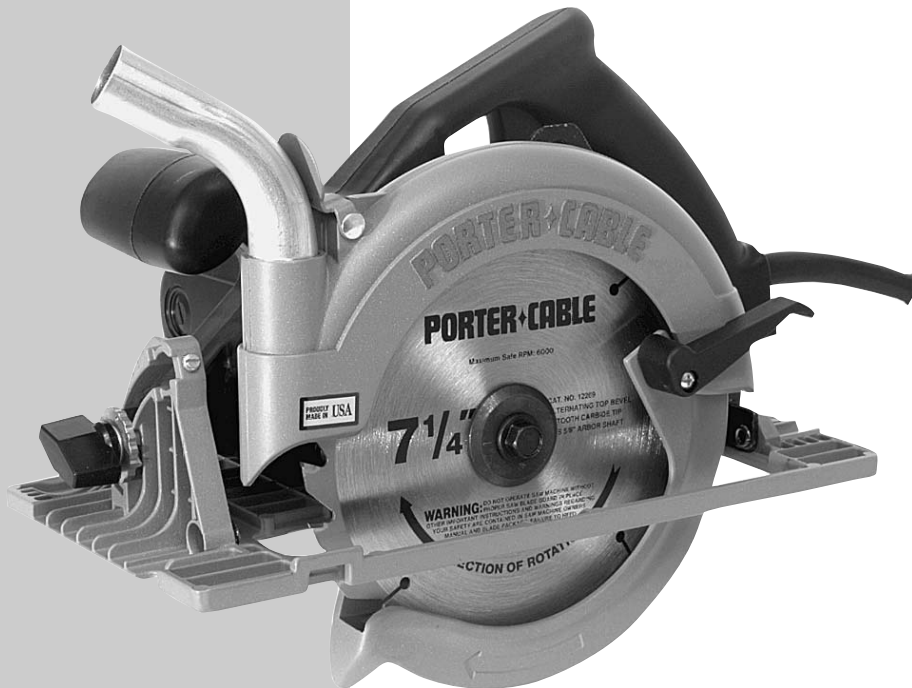

MODEL 743

IMPORTANT

Please make certain that the person who is to use this equipment carefully reads and understands these instructions before starting operations.

The Model and Serial No. plate is located on the main housing of the tool. Record these numbers in the spaces below and retain for future reference.

Model No. _____

Type _____

Serial No. _____

To learn more about Porter-Cable visit our website at:

<http://www.porter-cable.com>

PORTER-CABLE
PROFESSIONAL POWER TOOLS

Copyright © 2002 Porter-Cable Corporation

Part No. 900004 - 06-07-02

⚠ WARNING: SOME DUST CREATED BY POWER SANDING, SAWING, GRINDING, DRILLING, AND OTHER CONSTRUCTION ACTIVITIES

contains chemicals known to cause cancer, birth defects or other reproductive harm. Some examples of these chemicals are:

- lead from lead-based paints,
- crystalline silica from bricks and cement and other masonry products, and
- arsenic and chromium from chemically-treated lumber.

Your risk from these exposures varies, depending on how often you do this type of work. To reduce your exposure to these chemicals: work in a well ventilated area, and work with approved safety equipment, such as those dust masks that are specially designed to filter out microscopic particles.

GENERAL SAFETY RULES

⚠ WARNING: READ AND UNDERSTAND ALL INSTRUCTIONS.

Failure to follow all instructions listed below, may result in electric shock, fire and/or serious personal injury.

SAVE THESE INSTRUCTIONS.

WORK AREA

1. **Keep your work area clean and well lit.** Cluttered benches and dark areas invite accidents.
2. **Do not operate power tools in explosive atmospheres, such as in the presence of flammable liquids, gases, or dust.** Power tools create sparks which may ignite the dust or fumes.
3. **Keep bystanders, children, and visitors away while operating a power tool.** Distractions can cause you to lose control.

ELECTRICAL SAFETY

1. **Double insulated tools are equipped with a polarized plug (one blade is wider than the other). This plug will fit in a polarized outlet only one way. If the plug does not fit fully in the outlet, reverse the plug. If it still does not fit, contact a qualified electrician to install a polarized outlet. Do not change the plug in any way.** Double Insulation eliminates the need for the three wire grounded power cord and grounded power supply system.
2. **Avoid body contact with grounded surfaces such as pipes, radiators, ranges and refrigerators.** There is an increased risk of electric shock if your body is grounded.
3. **Don't expose power tools to rain or wet conditions.** Water entering a power tool will increase the risk of electric shock.
4. **Do not abuse the cord. Never use the cord to carry the tools or pull the plug from an outlet. Keep cord away from heat, oil, sharp edges or moving parts. Replace damaged cords immediately.** Damaged cords increase the risk of electric shock.
5. **When operating a power tool outside, use an outdoor extension cord marked "W-A" or "W".** These cords are rated for outdoor use and reduce the risk of electric shock.

PERSONAL SAFETY

1. **Stay alert, watch what you are doing, and use common sense when operating a power tool. Do not use tool while tired or under the influence**

of drugs, alcohol, or medication. A moment of inattention while operating power tools may result in serious personal injury.

2. Dress properly. Do not wear loose clothing or jewelry. Contain long hair. Keep your hair, clothing, and gloves away from moving parts. Loose clothes, jewelry, or long hair can be caught in moving parts.

3. Avoid accidental starting. Be sure switch is OFF before plugging in. Carrying tools with your finger on the switch or plugging in tools that have the switch ON invites accidents.

4. Remove adjusting keys or wrenches before turning the tool ON. A wrench or a key that is left attached to a rotating part of the tool may result in personal injury.

5. Do not overreach. Keep proper footing and balance at all times. Proper footing and balance enables better control of the tool in unexpected situations.

6. Use safety equipment. Always wear eye protection. Dust mask, non-skid safety shoes, hard hat, or hearing protection must be used for appropriate conditions.

TOOLS USE AND CARE

1. Use clamps or other practical way to secure and support the workpiece to a stable platform. Holding the work by hand or against your body is unstable and may lead to loss of control.

2. Do not force tool. Use the correct tool for your application. The correct tool will do the job better and safer at the rate for which it is designed.

3. Do not use tool if switch does not turn it ON or OFF. Any tool that cannot be controlled with the switch is dangerous and must be repaired.

4. Disconnect the plug from the power source before making any adjustments, changing accessories, or storing the tool. Such preventive safety measures reduce the risk of starting the tool accidentally.

5. Store idle tools out of reach of children and other untrained persons. Tools are dangerous in the hands of untrained users.

6. Maintain tools with care. Keep cutting tools sharp and clean. Properly maintained tools, with sharp cutting edges are less likely to bind and are easier to control.

7. Check for misalignment or binding of moving parts, breakage of parts, and any other condition that may affect the tool's operation. If damaged, have the tool serviced before using. Many accidents are caused by poorly maintained tools.

8. Use only accessories that are recommended by the manufacturer for your model. Accessories that may be suitable for one tool may become hazardous when used on another tool.

SERVICE

1. Tool service must be performed only by qualified repair personnel. Service or maintenance performed by unqualified personnel could result in a risk of injury.

2. When servicing a tool, use only identical replacement parts. Follow instructions in the Maintenance Section of this manual. Use of unauthorized parts or failure to follow Maintenance Instructions may create a risk of electric shock or injury.

SPECIFIC SAFETY RULES AND SYMBOLS FOR CIRCULAR SAWS

- 1. DANGER! Keep hands away from cutting area and blade. Keep your second hand on auxiliary handle or motor housing.** If both hands are holding the saw, they cannot be cut by the blade.
- 2. Keep your body positioned to either side of the saw blade, but not in line with the saw blade.** KICKBACK could cause the saw to jump backwards. (See "Causes and Operator Prevention of KICKBACK").
- 3. Do not reach underneath the work.** The guard cannot protect you from the blade below the work.
- 4. Check lower guard for proper closing before each use. Do not operate saw if lower guard does not move freely and close instantly. Never clamp or tie the lower guard into the open position.** If saw is accidentally dropped, lower guard may be bent. Raise the lower guard with the Retracting Handle and make sure it moves freely and does not touch the blade or any other part, in all angles and depths of cut.
- 5. Check the operation and condition of the lower guard spring. If the guard and the spring are not operating properly, they must be serviced before use.** Lower guard may operate sluggishly due to damaged parts, gummy deposits, or a buildup of debris.
- 6. Lower guard should be retracted manually only for special cuts such as "Pocket Cuts" and "Compound Cuts." Raise lower guard by retracting handle. As soon as blade enters the material, lower guard must be released.** For all other sawing, the lower guard should operate automatically.
- 7. Always observe that the lower guard is covering the blade before placing saw down on bench or floor.** An unprotected, coasting blade will cause the saw to walk backwards, cutting whatever is in its path. Be aware of the time it takes for the blade to stop after switch is released.
- 8. NEVER hold piece being cut in your hands or across your leg.** It is important to support the work properly to minimize body exposure, blade binding, or loss of control.
- 9. Hold tool by insulated gripping surfaces when performing an operation where the cutting tools may contact hidden wiring or its own cord.** Contact with a "live" wire will make exposed metal parts of the tool "live" and shock the operator.
- 10. When ripping always use a rip fence or straight edge guide.** This improves the accuracy of cut and reduces the chance for blade binding.
- 11. Always use blades with correct size and shape (diamond vs. round) arbor holes.** Blades that do not match the mounting hardware of the saw will run eccentrically, causing loss of control.
- 12. Never use damaged or incorrect blade washers or bolts.** The blade washers and bolt were specially designed for your saw, for optimum performance and safety of operation.
- 13. Causes and Operator Prevention of Kickback:**

Kickback is a sudden reaction to a pinched, bound, or misaligned saw blade, causing an uncontrolled saw to lift up and out of the workpiece toward the operator.

When the blade is pinched or bound tightly by the kerf closing down, the blade stalls and the motor reaction drives the unit rapidly back toward the operator.

If the blade becomes twisted or misaligned in the cut, the teeth at the back edge of the blade can dig into the top surface of the wood causing the blade to climb out of the kerf and jump back toward the operator.

Kickback is the result of tool misuse and/or incorrect operating procedures or conditions and can be avoided by taking proper precautions as given below:
- 14. Maintain a firm grip on the saw and position your body and arm in a way that allows you to resist KICKBACK forces.** KICKBACK forces can be controlled by the operator, if proper precautions are taken.

15. When blade is binding, or when interrupting a cut for any reason, release the trigger and hold the saw motionless in the material until the blade comes to a complete stop. Never attempt to remove the saw from the work or pull the saw backward while the blade is in motion or KICKBACK may occur. Investigate and take corrective actions to eliminate the cause of blade binding.

16. When restarting a saw in the workpiece, center the saw blade in the kerf and check that teeth are not engaged into the material. If saw blade is binding, it may walk up or KICKBACK from the workpiece as the saw is restarted.

17. Support large panels to minimize the risk of blade pinching and KICKBACK. Large panels tend to sag under their own weight. Supports must be placed under the panel on both sides, near the line of cut and near the edge of the panel.

18. Do not use dull or damaged blade. Unsharpened or improperly set blades produce narrow kerf causing excessive friction, blade binding, and KICKBACK.

19. Blade depth and bevel adjusting locking levers must be tight and secure before making cut. If blade adjustment shifts while cutting, it will cause binding and KICKBACK.





20. Use extra caution when making a "Pocket Cut" into existing walls or other blind areas. The protruding blade may cut objects that can cause KICKBACK.





21. Some wood contains preservatives which can be toxic. Take extra care to prevent inhalation and skin contact when working with these materials. Request, and follow, all safety information available from your material supplier.

22. ⚠ WARNING: There are certain applications for which this tool was designed. Porter-Cable strongly recommends that this tool NOT be modified and/or used for any application other than for which it was designed. If you have any questions relative to its application DO NOT use the tool until you have written Porter-Cable and we have advised you.

Technical Service Manager
 Porter-Cable Corporation
 4825 Highway 45 North
 Jackson, TN 38305

SAVE THESE INSTRUCTIONS.

SYMBOL	DEFINITION
V volts
A amperes
Hz hertz
W watts
kW kilowatts
μF microfarads
l liters
kg kilograms
N/cm ² newtons per square centimeter
Pa pascals
h hours
min minutes
s seconds
 alternating current
3  three-phase alternating current
3N  three-phase alternating current with neutral
 direct current
n ₀ no load

-  alternating or direct current
-  Class II Construction
-  splash-proof construction
-  watertight construction
- .../min revolutions or reciprocation per minute

REPLACEMENT PARTS

When servicing use only identical replacement parts.

MOTOR

Many Porter-Cable tools will operate on either D.C., or single phase 25 to 60 cycle A.C. current and voltage within plus or minus 5 percent of that shown on the specification plate on the tool. Several models, however, are designed for A.C. current only. Refer to the specification plate on your tool for proper voltage and current rating.

CAUTION: Do not operate your tool on a current on which the voltage is not within correct limits. Do not operate tools rated A.C. only on D.C. current. To do so may seriously damage the tool.

EXTENSION CORD SELECTION

If an extension cord is used, make sure the conductor size is large enough to prevent excessive voltage drop which will cause loss of power and possible motor damage. A table of recommended extension cord sizes will be found below. This table is based on limiting line voltage drop to 5 volts (10 volts for 230 volts) at 150% of rated amperes.

If an extension cord is to be used outdoors it must be marked with the suffix W-A or W following the cord type designation. For example – SJTW-A to indicate it is acceptable for outdoor use.

RECOMMENDED EXTENSION CORD SIZES FOR USE WITH PORTABLE ELECTRIC TOOLS

		Length of Cord in Feet									
		115V	25 Ft.	50 Ft.	100 Ft.	150 Ft.	200 Ft.	250 Ft.	300 Ft.	400 Ft.	500 Ft.
		230V	50 Ft.	100 Ft.	200 Ft.	300 Ft.	400 Ft.	500 Ft.	600 Ft.	800 Ft.	1000 Ft.
Nameplate Ampere Rating	0-2		18	18	18	16	16	14	14	12	12
	2-3		18	18	16	14	14	12	12	10	10
	3-4		18	18	16	14	12	12	10	10	8
	4-5		18	18	14	12	12	10	10	8	8
	5-6		18	16	14	12	10	10	8	8	6
	6-8		18	16	12	10	10	8	6	6	6
	8-10		18	14	12	10	8	8	6	6	4
	10-12		16	14	10	8	8	6	6	4	4
	12-14		16	12	10	8	6	6	6	4	2
	14-16		16	12	10	8	6	6	4	4	2
	16-18		14	12	8	8	6	4	4	2	2
	18-20		14	12	8	6	6	4	4	2	2

FUNCTIONAL DESCRIPTION

FOREWORD

Your Porter-Cable circular saw is designed for use with 7¹/₄" diameter blades that have a 5/8" diameter bore. Blades must be rated for 6000 RPM operation (or higher).

A mounting flange kit for diamond-hole blades is available. This kit adapts the saw for use with 7¹/₄" diameter blades that have a diamond-shaped mounting hole.

SELECTING A BLADE

A combination blade is furnished with your saw and is an excellent blade for all general ripping and crosscutting operations. A fine tooth blade is recommended for cutting plywood. A diamond blade is available for dry cutting concrete, brick, stone, etc.

REMOVING THE BLADE

1. **CAUTION:** DISCONNECT TOOL FROM POWER SOURCE.
2. Push in blade lock (A) Fig. 1, and rotate blade by hand until lock engages blade arbor.

CAUTION: AVOID CONTACT WITH BLADE TEETH TO PREVENT PERSONAL INJURY.

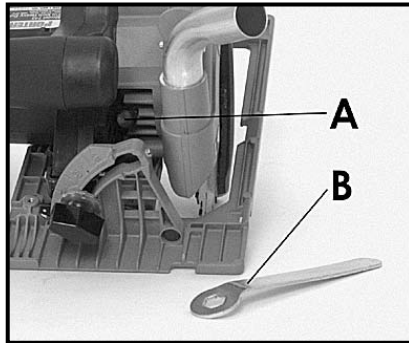

Fig. 1

3. While holding blade lock engaged, use wrench provided (B) Fig. 1, and loosen blade retaining bolt by rotating clockwise (left-hand thread).
4. Remove blade retaining bolt, release blade lock and remove outer blade flange.
5. Retract telescoping guard and remove blade.

INSTALLING THE BLADE

1. **CAUTION:** DISCONNECT TOOL FROM POWER SOURCE.
2. Remove any sawdust that may have accumulated within guards and around arbor. Check the telescoping guard to insure it is in working order.
3. Clean inner blade flange, retract telescoping guard, and place sharp blade on arbor making sure teeth point up at front of saw as shown in Fig. 2.

CAUTION: AVOID CONTACT WITH BLADE TEETH TO PREVENT PERSONAL INJURY.

4. Place outer blade flange on arbor with flange towards blade and flats mating with those on arbor.
5. Replace blade retaining bolt and finger tighten by turning counterclockwise.
6. Push in blade lock and rotate blade arbor by hand until lock engages arbor. Tighten blade retaining bolt securely with wrench provided and release blade lock.

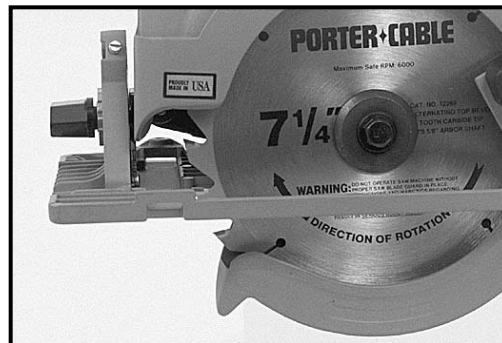

Fig. 2

TELESCOPING GUARD

⚠ WARNING: The telescoping guard (A) Fig. 3, is a safety device important to your protection. Every time you use the saw, see that the telescoping guard rotates freely and returns quickly and completely to its closed position. At least once a month, remove any accumulated sawdust, pitch, etc., from the area around the hub (B), of the telescoping guard. **DO NOT LUBRICATE THIS AREA.** The hub has a dry film lubricated surface that does not need oiling. **NEVER** block or wedge the telescoping guard in the open position.

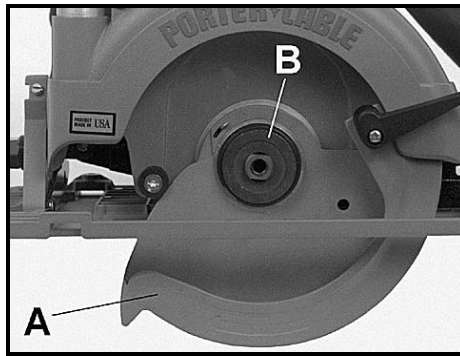

Fig. 3

CAUTION: NEVER use your saw if the telescoping guard is not in working order. If telescoping guard movement is sluggish or binding exists, return the saw to your nearest **AUTHORIZED PORTER-CABLE SERVICE STATION** or **PORTER-CABLE SERVICE CENTER** for repair.

TO ADJUST DEPTH OF CUT FOR NORMAL CUTTING

It is recommended that the depth of cut be adjusted so that the saw blade just protrudes through the thickness of material being cut. Adjust depth of cut as follows:

1. **CAUTION:** DISCONNECT TOOL FROM POWER SOURCE.
2. Lift up depth adjustment locking lever (A) Fig. 4, at rear of saw.
3. Raise or lower saw housing until the blade extends the desired distance below base.

NOTE: The upper guard (B) Fig. 4, is marked in $\frac{1}{4}$ " increments for convenience in setting depth of cut. Align the depth segment mark (C) Fig. 4, with the desired depth marking on the guard.

4. Press depth adjusting locking lever down firmly locking saw in selected position.

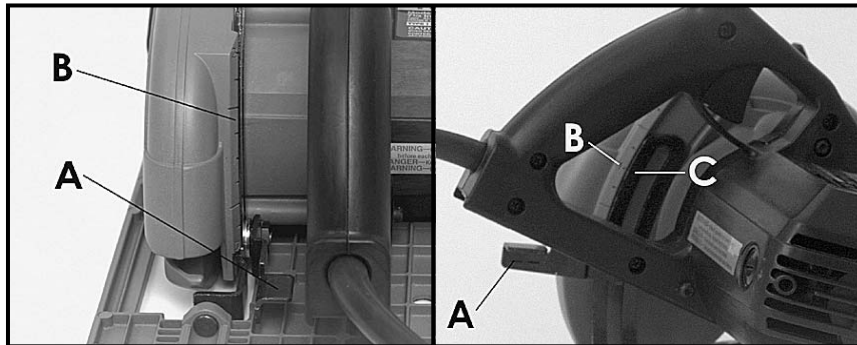

Fig. 4

TO ADJUST FOR BEVEL CUTS

1. **CAUTION:** DISCONNECT TOOL FROM POWER SOURCE.
2. Loosen the bevel adjusting knob (A) Fig. 5.
3. Tilt saw base until desired graduation line on the bevel segment (B) Fig. 5, lines up with indicating mark (C) Fig. 5, on bracket.

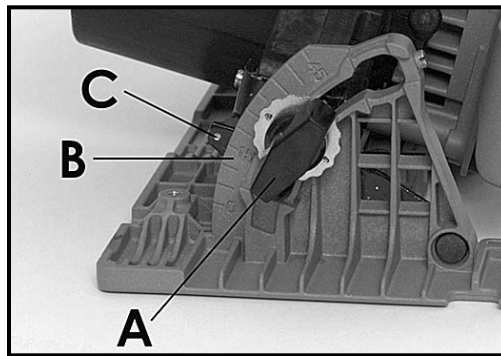

Fig. 5

4. Tighten bevel adjustment knob firmly.

90° AND 45° BEVEL POSITIVE STOPS

The saw is equipped with adjustable positive stops at both 90° (A) Fig. 6, and 45° (B) Fig. 6. It is recommended that the accuracy of these stops be checked periodically and adjustments be made as necessary. These procedures are explained fully in the following sections of this manual.

BACK CUTS

This saw can be adjusted for bevel cuts of up to 3° beyond the positive stop at either the 45° or the 90° position. In normal operation the bevel stop sleeve (C) Fig. 6, is aligned as shown in Fig. 6. To adjust the saw for a bevel cut beyond the normal 45° to 90° range:

1. **CAUTION:** DISCONNECT TOOL FROM POWER SOURCE.
2. Set saw for either a 45° or a 90° bevel cut.
3. Loosen bevel adjustment knob approximately two turns.
4. Pull out on the bevel stop sleeve (C) Fig. 6. Rotate sleeve to the position shown in Fig. 6A and push sleeve back in.

The saw can now be adjusted for a bevel cut 3° beyond the normal stop.

5. Position saw to desired angle and firmly tighten bevel adjustment knob.

NOTE: The bevel stop sleeve must be returned to the normal position (see Fig. 6), before the saw can be adjusted for a bevel cut of between 45° and 90°.

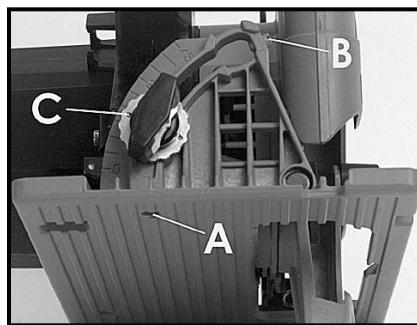

Fig. 6

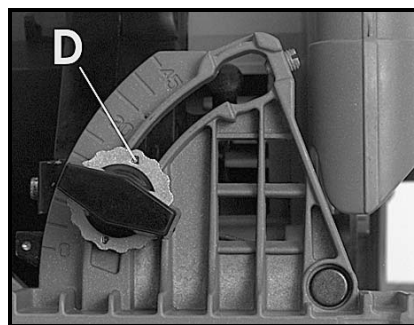

Fig. 6A

TO ADJUST 90° POSITIVE STOP

1. **CAUTION:** DISCONNECT TOOL FROM POWER SOURCE.
2. Set bevel stop sleeve to normal position (see Fig. 6).
3. Loosen bevel adjustment knob (A) Fig. 5, and position base for 90° cut being sure that the bevel stop sleeve is against the 90° stop screw.
4. Turn saw upside down, retract telescoping guard and check squareness of blade as shown in Fig. 7.
5. If adjustment is necessary, loosen bevel adjustment knob, keeping bevel stop sleeve in contact with stop screw, turn stop screw (see Fig. 6) until squareness is obtained.

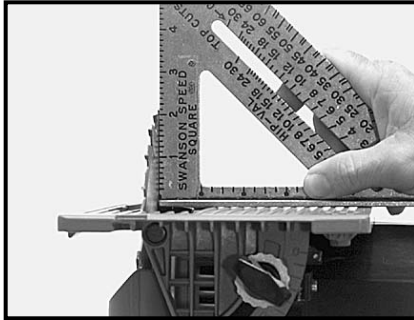

Fig. 7

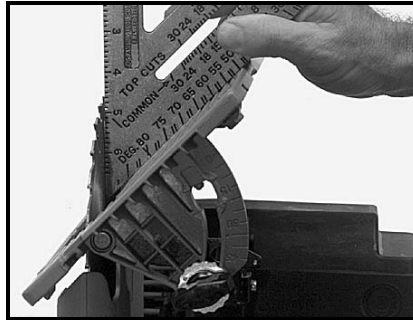

Fig. 8

TO ADJUST 45° BEVEL POSITIVE STOP

1. **CAUTION:** DISCONNECT TOOL FROM POWER SOURCE.
2. Set bevel stop sleeve to normal position (see Fig. 6).
3. Loosen bevel adjustment knob (A) Fig. 5, and position base for 45° cut being sure that the bevel stop sleeve is against the 45° stop screw.
4. Turn saw upside down, retract telescoping guard and check 45° angle as shown in Fig. 8.
5. If adjustment is necessary, loosen bevel adjustment knob and turn stop screw (see Fig. 6) until angle is correct.

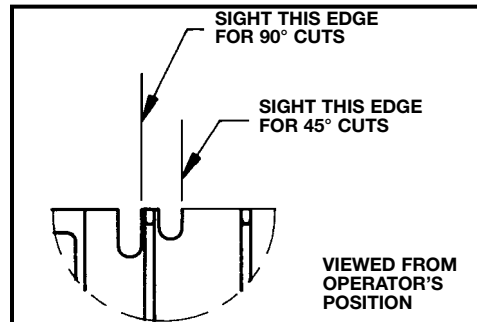

Fig. 9

LINE-OF-CUT INDICATOR

Line-of-cut indicator slots (see Fig. 9), are provided at the front of the saw base. The left slot is used to follow a line when making a 90° cut. The right slot is used to follow a line when making a 45° cut.

BLADE WRENCH STORAGE

Blade wrench storage is provided in the bottom of the saw handle (see Fig. 10). Position the handle end of the blade wrench into the storage slot and push forward until seated.



Fig. 10

INSTALLING SAWDUST EXHAUST NOZZLE

An exhaust nozzle is provided to direct sawdust away from operator and the line of cut. This nozzle can be installed as follows:

1. **CAUTION: DISCONNECT TOOL FROM POWER SOURCE.**
2. Swing open exhaust cover (A) Fig. 11, and clean out any sawdust that may have accumulated.
3. Insert nozzle in exhaust opening and push in until seated.
4. To remove, grasp nozzle where it enters exhaust opening and pull out.

CAUTION: Never direct sawdust toward the operator. To avoid personal injury from flying sawdust, the exhaust cover should be kept closed at all times the nozzle is not assembled. NEVER insert foreign objects into exhaust opening.



Fig. 11

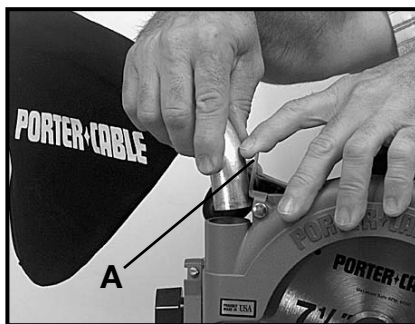

Fig. 12

INSTALLING AND CARE OF DUST BAG

A dust bag is available as an accessory. Install dust bag as follows:

1. **CAUTION: DISCONNECT TOOL FROM POWER SOURCE.**
2. Swing open exhaust cover (A) Fig. 12, and clean out any sawdust that may have accumulated.
3. Insert dust bag tube in exhaust opening and push in until seated.
4. To remove, grasp dust bag tube where it enters exhaust opening and pull out.
5. Unzip bag and shake out sawdust. Occasionally turn bag inside out and brush out thoroughly.

CAUTION: To avoid personal injury from flying sawdust, the exhaust cover should be kept closed at all times the dust bag is not assembled. NEVER insert foreign objects into exhaust opening.

VACUUM CLEANER ADAPTER

An accessory vacuum hose assembly is available for connecting the exhaust nozzle directly to a shop-type vacuum cleaner.

RIP GUIDE

A rip guide (A), Fig. 13, is available as an accessory. Install rip guide as follows:

1. **CAUTION:** DISCONNECT TOOL FROM POWER SOURCE.
2. Insert rip guide through slot in left side of saw base. Slide the guide in until it extends through the slot in right side of base.
3. Position the compression spring to the thumb screw (supplied with the rip guide), and thread into the hole in the saw base. **DO NOT TIGHTEN.**
4. Adjust the rip guide for the desired width of cut and tighten the thumb screw.

CAUTION: To avoid personal injury and damage to workpiece, the rip guide must always extend through both slots in base.

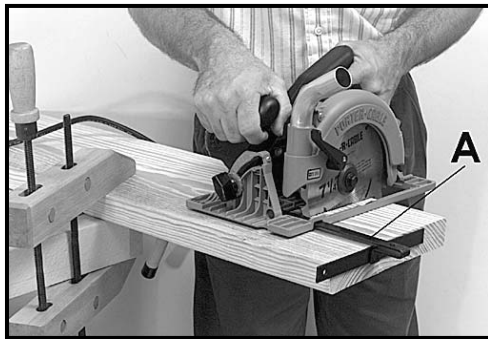

Fig. 13

HOW TO USE THE SAW

For maximum protection of the operator, effective control of this powerful saw requires two-handed operation.

⚠ WARNING: It is important to support the work properly and to hold the saw firmly to prevent loss of control which could cause personal injury. Fig. 14 illustrates proper hand support of the saw.

Clamp work on a rigid support such as a bench or saw horses. See Fig. 14. Mark the line of cut on the work. Be sure cut-off line is beyond end of support to the left only enough to allow proper operation of the telescoping guard. Place front edge of saw squarely on work before starting motor. Sight the cutting line with the line-of-cut indicator Fig. 9. Back saw up slightly and start motor. Move saw forward keeping the edge of line indicator parallel to line of cut.

CAUTION: Keep the cord away from cutting area, so it does not get hung up in the work being cut. See Fig. 14.

Do not force the cut. Let the saw do the cutting at the rate of speed permitted by the type of cut and the material being cut. When the cut is completed, release the switch and allow the blade to stop before lifting the saw from the work. On through-cuts, be sure the lower blade guard is closed, before setting the saw down.



Fig. 14

CROSSCUTTING

Cutting directly across the grain of a piece of lumber is called crosscutting. Fig. 14 illustrates a crosscut operation. Position the work so that the cut will be on the left, as shown.

RIPPING

Cutting wood lengthwise is referred to as ripping. This operation is performed in the same manner as crosscutting with the exception of supporting the material to be cut. If material is supported on a large table, bench or floor, several pieces of scrap stock approximately one inch thick should be placed beneath the material to allow clearance for the portion of the saw blade that extends through the material. Large sheets of paneling or thin plywood supported on saw horses should have 2 x 4's placed lengthwise between the horses and the material, to prevent it from sagging in the center.

For narrow rip cuts, the rip guide, available as an accessory can be used. The saw is guided by keeping the inner face of the rip guide, Fig. 13, tight against the edge of the board.

For making wider cuts, such as might be made in plywood and wide sheets, a wooden guide strip or a commercial cutting guide can be tacked or clamped to the work. The left edge of the saw base can then be guided, as shown in Fig. 15. NOTE: The line of the cut must be adjusted to allow for the width of the guide.

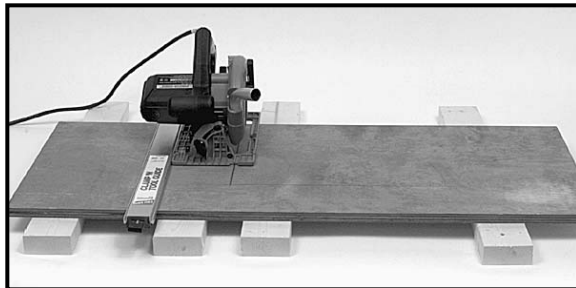

Fig. 15

BEVEL CUTTING

Bevel cuts are made in the same manner as crosscuts and rip cuts. The only difference is that the blade is set at an angle between 0° and 45° , as shown in Fig. 16.

The bevel cut made at an angle to the edge of a board is called a compound cut. There are certain compound cuts, on which it may be necessary to manually retract the telescoping guard, to allow the blade to enter into and/or through the cut.

CAUTION: Use the lever (A) Fig. 14, provided on the telescoping guard when you have to retract the telescoping guard manually.

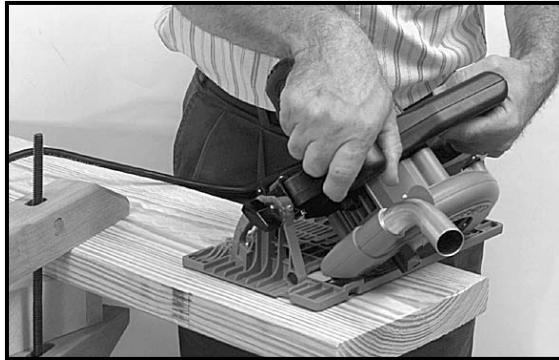

Fig. 16

POCKET CUTS (PLUNGE CUTTING)

A pocket cut is one which must be made inside the area of the material and not starting from the edge. Mark the area clearly with lines on all sides. Start near the corner of one side and place front edge of saw base firmly on the work. Hold saw up so blade clears the material. Be sure you have adjusted the blade properly for depth of cut. Push the telescoping guard lever all the way back so the blade is exposed as shown in Fig. 17. Start the motor and lower the blade into the work. After the blade has cut through, and the base rests flat on the work, follow the line right up to the corner. Use a keyhole or bayonet saw to cut the corners out clean.



Fig. 17

MAINTENANCE

KEEP TOOL CLEAN

Periodically blow out all air passages with dry compressed air. All plastic parts should be cleaned with a soft damp cloth. NEVER use solvents to clean plastic parts. They could possibly dissolve or otherwise damage the material.

CAUTION: Wear safety glasses while using compressed air.

FAILURE TO START

Should your tool fail to start, check to make sure the prongs on the cord plug are making good contact in the outlet. Also, check for blown fuses or open circuit breakers in the line.

LUBRICATION

Your machine is lubricated at the factory with sufficient lubricant to last for approximately 100 hours of operation. To add lubricant, it is necessary to dismantle the tool. This operation should always be handled by the nearest PORTER-CABLE AUTHORIZED SERVICE CENTER. All repairs and servicing made by these centers are fully guaranteed against defective materials and workmanship.

BRUSH INSPECTION AND LUBRICATION

For your continued safety and electrical protection, brush inspection and replacement on this tool should ONLY be performed by an AUTHORIZED PORTER-CABLE SERVICE STATION or a PORTER-CABLE•DELTA FACTORY SERVICE CENTER.

At approximately 100 hours of use, take or send your tool to your nearest authorized Porter-Cable Service Station to be thoroughly cleaned and inspected. Have worn parts replaced and lubricate with fresh lubricant. Have new brushes installed, and test the tool for performance.

Any loss of power before the above maintenance check may indicate the need for immediate servicing of your tool. DO NOT CONTINUE TO OPERATE TOOL UNDER THIS CONDITION. If proper operating voltage is present, return your tool to the service station for immediate service.

SERVICE AND REPAIRS

All quality tools will eventually require servicing or replacement of parts due to wear from normal use. These operations, including brush inspection and replacement, should ONLY be performed by either an AUTHORIZED PORTER-CABLE SERVICE STATION or a PORTER-CABLE•DELTA FACTORY SERVICE CENTER. All repairs made by these agencies are fully guaranteed against defective material and workmanship. We cannot guarantee repairs made or attempted by anyone other than these agencies.

Should you have any questions about your tool, feel free to write us at any time. In any communications, please give all information shown on the nameplate of your tool (model number, type, serial number, etc.).

ACCESSORIES

A complete line of accessories is available from your Porter-Cable • Delta Supplier, Porter-Cable • Delta Factory Service Centers, and Porter-Cable Authorized Service Stations. Please visit our Web Site www.porter-cable.com for a catalog or for the name of your nearest supplier.

⚠ WARNING: Since accessories other than those offered by Porter-Cable • Delta have not been tested with this product, use of such accessories could be hazardous. For safest operation, only Porter-Cable •Delta recommended accessories should be used with this product.

PORTER-CABLE LIMITED ONE YEAR WARRANTY

Porter-Cable warrants its Professional Power Tools for a period of one year from the date of original purchase. We will repair or replace at our option, any part or parts of the product and accessories covered under this warranty which, after examination, proves to be defective in workmanship or material during the warranty period. For repair or replacement return the complete tool or accessory, transportation prepaid, to your nearest Porter-Cable Service Center or Authorized Service Station. Proof of purchase may be required. This warranty does not apply to repair or replacement required due to misuse, abuse, normal wear and tear or repairs attempted or made by other than our Service Centers or Authorized Service Stations.

ANY IMPLIED WARRANTY, INCLUDING THE IMPLIED WARRANTIES OF MERCHANTABILITY AND FITNESS FOR A PARTICULAR PURPOSE, WILL LAST ONLY FOR ONE (1) YEAR FROM THE DATE OF PURCHASE.

To obtain information on warranty performance please write to: PORTER-CABLE CORPORATION, 4825 Highway 45 North, Jackson, Tennessee 38305; Attention: Product Service. THE FOREGOING OBLIGATION IS PORTER-CABLE'S SOLE LIABILITY UNDER THIS OR ANY IMPLIED WARRANTY AND UNDER NO CIRCUMSTANCES SHALL PORTER-CABLE BE LIABLE FOR ANY INCIDENTAL OR CONSEQUENTIAL DAMAGES. Some states do not allow limitations on how long an implied warranty lasts or the exclusion or limitation of incidental or consequential damages, so the above limitation or exclusion may not apply to you.

This warranty gives you specific legal rights and you may also have other legal rights which vary from state to state.

**PORTER-CABLE • DELTA SERVICE CENTERS
(CENTROS DE SERVICIO DE PORTER-CABLE • DELTA)
(CENTRE DE SERVICE PORTER-CABLE • DELTA)**

**Parts and Repair Service for Porter-Cable • Delta Power Tools are Available at These Locations
(Obtenga Refaccion de Partes o Servicio para su Herramienta en los Siguietes Centros de Porter-Cable • Delta)
(Locations où vous trouverez les pièces de rechange nécessaires ainsi qu'un service d'entretien)**

ARIZONA

Tempe 85282 (Phoenix)
2400 West Southern Avenue
Suite 105
Phone: (602) 437-1200
Fax: (602) 437-2200

CALIFORNIA

Ontario 91761 (Los Angeles)
3949A East Guasti Road
Phone: (909) 390-5555
Fax: (909) 390-5554
San Leandro 94577 (Oakland)
3039 Teagarden Street
Phone: (510) 357-9762
Fax: (510) 357-7939

COLORADO

Arvada 80003 (Denver)
8175 Sheridan Blvd., Unit S
Phone: (303) 487-1809
Fax: (303) 487-1868

FLORIDA

Davie 33314 (Miami)
4343 South State Rd. 7 (441)
Unit #107
Phone: (954) 321-6635
Fax: (954) 321-6638
Tampa 33609
4538 W. Kennedy Boulevard
Phone: (813) 877-9585
Fax: (813) 269-7948

GEORGIA

Forest Park 30297 (Atlanta)
5442 Frontage Road,
Suite 112
Phone: (404) 608-0006
Fax: (404) 608-1123

ILLINOIS

Addison 60101 (Chicago)
400 South Rohlwing Rd.
Phone: (630) 424-8805
Fax: (630) 424-8895

Woodridge 60517 (Chicago)
2033 West 75th Street
Phone: (630) 910-9200
Fax: (630) 910-0360

MARYLAND

Elkridge 21075 (Baltimore)
7397-102 Washington Blvd.
Phone: (410) 799-9394
Fax: (410) 799-9398

MASSACHUSETTS

Braintree 02185 (Boston)
719 Granite Street
Phone: (781) 848-9810
Fax: (781) 848-6759

Franklin 02038 (Boston)
Franklin Industrial Park
101E Constitution Blvd.
Phone: (508) 520-8802
Fax: (508) 528-8089

MICHIGAN

Madison Heights 48071 (Detroit)
30475 Stephenson Highway
Phone: (248) 597-5000
Fax: (248) 597-5004

MINNESOTA

Minneapolis 55429
5622 Lakeland Avenue North
Phone: (763) 561-9080
Fax: (763) 561-0653

MISSOURI

North Kansas City 64116
1141 Swift Avenue
P.O. Box 12393
Phone: (816) 221-2070
Fax: (816) 221-2897

St. Louis 63119
7574 Watson Road
Phone: (314) 968-8950
Fax: (314) 968-2790

NEW YORK

Flushing 11365-1595 (N.Y.C.)
175-25 Horace Harding Expwy.
Phone: (718) 225-2040
Fax: (718) 423-9619

NORTH CAROLINA

Charlotte 28270
9129 Monroe Road, Suite 115
Phone: (704) 841-1176
Fax: (704) 708-4625

OHIO

Columbus 43214
4560 Indianola Avenue
Phone: (614) 263-0929
Fax: (614) 263-1238

Cleveland 44125
8001 Sweet Valley Drive
Unit #19
Phone: (216) 447-9030
Fax: (216) 447-3097

OREGON

Portland 97230
4916 NE 122 nd Ave.
Phone: (503) 252-0107
Fax: (503) 252-2123

PENNSYLVANIA

Willow Grove 19090
520 North York Road
Phone: (215) 658-1430
Fax: (215) 658-1433

TEXAS

Carrollton 75006 (Dallas)
1300 Interstate 35 N, Suite 112
Phone: (972) 446-2996
Fax: (972) 446-8157

Houston 77055
West 10 Business Center
1008 Wirt Road, Suite 120
Phone: (713) 682-0334
Fax: (713) 682-4867

WASHINGTON

Auburn 98001 (Seattle)
3320 West Valley HWY, North
Building D, Suite 111
Phone: (253) 333-8353
Fax: (253) 333-9613

Authorized Service Stations are located in many large cities. Telephone **800-487-8665** or **731-541-6042** for assistance locating one. Parts and accessories for Porter-Cable • Delta products should be obtained by contacting any Porter-Cable • Delta Distributor, Authorized Service Center, or Porter-Cable • Delta Factory Service Center. If you do not have access to any of these, call **888-848-5175** and you will be directed to the nearest Porter-Cable • Delta Factory Service Center. Las Estaciones de Servicio Autorizadas están ubicadas en muchas grandes ciudades. Llame al **800-487-8665** ó al **731-541-6042** para obtener asistencia a fin de localizar una. Las piezas y los accesorios para los productos Porter-Cable • Delta deben obtenerse poniéndose en contacto con cualquier distribuidor Porter-Cable • Delta, Centro de Servicio Autorizado o Centro de Servicio de Fábrica Porter-Cable • Delta. Si no tiene acceso a ninguna de estas opciones, llame al **888-848-5175** y le dirigirán al Centro de Servicio de Fábrica Porter-Cable • Delta más cercano. Des centres de service agréés sont situés dans beaucoup de grandes villes. Appelez au **800-487-8665** ou au **731-541-6042** pour obtenir de l'aide pour en repérer un. Pour obtenir des pièces et accessoires pour les produits Porter-Cable • Delta, s'adresser à tout distributeur Porter-Cable • Delta, centre de service agréé ou centre de service d'usine Porter-Cable • Delta. Si vous n'avez accès à aucun de ces centres, appeler le **888-848-5175** et on vous dirigera vers le centre de service d'usine Porter-Cable • Delta le plus proche.

CANADIAN PORTER-CABLE • DELTA SERVICE CENTERS

ALBERTA

Bay 6, 2520-23rd St. N.E.
Calgary, Alberta
T2E 8L2
Phone: (403) 735-6166
Fax: (403) 735-6144

BRITISH COLUMBIA

8520 Baxter Place
Burnaby, B.C.
V5A 4T8
Phone: (604) 420-0102
Fax: (604) 420-3522

MANITOBA

1699 Dublin Avenue
Winnipeg, Manitoba
R3H 0H2
Phone: (204) 633-9259
Fax: (204) 632-1976

ONTARIO

505 Southgate Drive
Guelph, Ontario
N1H 6M7
Phone: (519) 836-2840
Fax: (519) 767-4131

QUÉBEC

1515 Ave.
St-Jean Baptiste,
Québec, Québec
G2E 5E2
Phone: (418) 877-7112
Fax: (418) 877-7123
1447, Begin
St-Laurent, (Montréal), Québec
H4R 1V8
Phone: (514) 336-8772
Fax: (514) 336-3505

The following are trademarks of PORTER-CABLE • DELTA (Las siguientes son marcas registradas de PORTER-CABLE • DELTA S.A.) (Les marques suivantes sont des marques de fabricant de la PORTER-CABLE • DELTA): Auto-Set®, BAMMER®, B.O.S.S.®, Builder's Saw®, Contractor's Saw®, Contractor's Saw II™, Delta™, DELTACRAFT™, DELTAGRAM™, Delta Series 2000™, DURATRONIC™, Emc2™, FLEX®, Flying Chips™, FRAME SAW®, Homecraft®, INNOVATION THAT WORKS®, Jet-Lock®, JETSTREAM®, kickstand®, LASERLOC®, MICRO-SET®, Micro-Set™, Midi Lathe™, MORTEN™, NETWORK™, OMNIJIG®, POCKET CUTTER®, PORTA-BAND®, PORTA-PLANE®, PORTER-CABLE®&(design), PORTER-CABLE®PROFESSIONAL POWER TOOLS, Posi-Matic®, Q-3®&(design), QUICKSAND®&(design), QUICKSET™, QUICKSET II®, QUICKSET PLUS™, RIPTIDE™&(design), SAFE GUARD II®, SAFE-LOC®, Sanding Center®, SANDTRAP®&(design), SAW BOSS®, Sawbuck™, Sidekick®, SPEED-BLOC®, SPEEDMATIC®, SPEEDTRONIC®, STAIR EASE®, The American Woodshop®&(design), The Lumber Company®&(design), THE PROFESSIONAL EDGE®, THE PROFESSIONAL SELECT®, THIN-LINE™, TIGER®, TIGER CUB®, TIGER SAW®, TORQBUSTER®, TORQ-BUSTER®, TRU-MATCH™, TWIN-LITE®, UNIGUARD®, Unifence®, UNIFEEDER™, Unihead®, Uniplane™, Unirip®, Unisaw®, Univise®, Versa-Feeder®, VERSA-PLANE®, WHISPER SERIES®, WOODWORKER'S CHOICE™.

Trademarks noted with ™ and ® are registered in the United States Patent and Trademark Office and may also be registered in other countries. Las Marcas Registradas con el signo de ™ y ® son registradas por la Oficina de Registros y Patentes de los Estados Unidos y también pueden estar registradas en otros países. Marques déposées, indiquées par la lettre ™ et ®, sont déposées au Bureau des brevets d'invention et marques déposées aux Etats-Unis et pourraient être déposées aux autres pays.

Printed in U.S.A.