

**Instruction  
manual**

**PORTA-PLANE®  
PLANER**

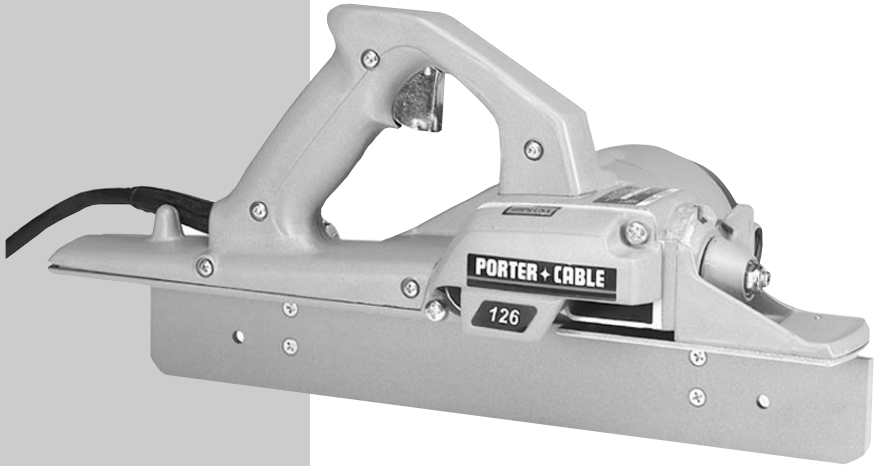

**MODEL 126**

**IMPORTANT**

Please make certain that the person who is to use this equipment carefully reads and understands these instructions before starting operations.

The Model and Serial No. plate is located on the main housing of the tool. Record these numbers in the spaces below and retain for future reference.

Model No. \_\_\_\_\_

Type \_\_\_\_\_

Serial No. \_\_\_\_\_

To learn more about Porter-Cable  
visit our website at:

<http://www.porter-cable.com>

**PORTER+CABLE**  
PROFESSIONAL POWER TOOLS

## TABLE OF CONTENTS

<b>IMPORTANT SAFETY INSTRUCTIONS</b> .....	2
<b>SAFETY GUIDELINES</b> .....	3
<b>GENERAL SAFETY RULES</b> .....	4
<b>ADDITIONAL SPECIFIC SAFETY RULES</b> .....	6
<b>CARTON CONTENTS</b> .....	9
<b>FUNCTIONAL DESCRIPTION</b> .....	9
<b>ASSEMBLY</b> .....	9
<b>OPERATION</b> .....	9
<b>TROUBLESHOOTING</b> .....	13
<b>MAINTENANCE</b> .....	14
<b>SERVICE</b> .....	15
<b>ACCESSORIES</b> .....	15
<b>WARRANTY</b> .....	16
<b>ESPAÑOL</b> .....	17

## IMPORTANT SAFETY INSTRUCTIONS

**▲ WARNING** Read and understand all warnings and operating instructions before using any tool or equipment. When using tools or equipment, basic safety precautions should always be followed to reduce the risk of personal injury. Improper operation, maintenance or modification of tools or equipment could result in serious injury and property damage. There are certain applications for which tools and equipment are designed. Porter-Cable strongly recommends that this product NOT be modified and/or used for any application other than for which it was designed.

If you have any questions relative to its application DO NOT use the product until you have written Porter-Cable and we have advised you.

Online contact form at [www.porter-cable.com](http://www.porter-cable.com)

Postal Mail: Technical Service Manager

Porter-Cable  
4825 Highway 45 North  
Jackson, TN 38305

Information regarding the safe and proper operation of this tool is available from the following sources:

Power Tool Institute

1300 Sumner Avenue, Cleveland, OH 44115-2851

[www.powertoolinstitute.org](http://www.powertoolinstitute.org)

National Safety Council

1121 Spring Lake Drive, Itasca, IL 60143-3201

American National Standards Institute, 25 West 43rd Street, 4 floor, New York, NY 10036 [www.ansi.org](http://www.ansi.org) ANSI O1.1 Safety Requirements for Woodworking Machines, and the U.S. Department of Labor regulations [www.osha.gov](http://www.osha.gov)

**SAVE THESE INSTRUCTIONS!**

## SAFETY GUIDELINES - DEFINITIONS

It is important for you to read and understand this manual. The information it contains relates to protecting YOUR SAFETY and PREVENTING PROBLEMS. The symbols below are used to help you recognize this information.



### **▲ DANGER**

indicates an imminently hazardous situation which, if not avoided, will result in death or serious injury.

### **▲ WARNING**

indicates a potentially hazardous situation which, if not avoided, could result in death or serious injury.

### **▲ CAUTION**

indicates a potentially hazardous situation which, if not avoided, may result in minor or moderate injury.

### **CAUTION**

used without the safety alert symbol indicates a potentially hazardous situation which, if not avoided, may result in property damage.

## CALIFORNIA PROPOSITION 65

### **▲ WARNING**

Some dust created by power sanding, sawing, grinding, drilling, and other construction activities contains chemicals known (to the State of California) to cause cancer, birth defects or other reproductive harm. Some examples of these chemicals are:

- lead from lead-based paints
- crystalline silica from bricks and cement and other masonry products
- arsenic and chromium from chemically-treated lumber

Your risk from these exposures varies, depending on how often you do this type of work. To reduce your exposure to these chemicals: work in a well ventilated area, and work with approved safety equipment, always wear NIOSH/OSHA approved, properly fitting face mask or respirator when using such tools.

# GENERAL SAFETY RULES

**▲ WARNING** Read all instructions. Failure to follow all instructions listed below may result in electric shock, fire and/or serious injury. The term "power tool" in all of the warnings listed below refers to your mains-operated (corded) power tool or battery-operated (cordless) power tool.



SAVE THESE INSTRUCTIONS

## 1) Work area safety

- a) **Keep work area clean and well lit.** Cluttered or dark areas invite accidents.
- b) **Do not operate power tools in explosive atmospheres, such as in the presence of flammable liquids, gases or dust.** Power tools create sparks which may ignite the dust or fumes.
- c) **Keep children and bystanders away while operating a power tool.** Distractions can cause you to lose control.

## 2) Electrical safety

- a) **Power tool plugs must match the outlet. Never modify the plug in any way. Do not use any adapter plugs with earthed (grounded) power tools.** Unmodified plugs and matching outlets will reduce risk of electric shock.
- b) **Avoid body contact with earthed or grounded surfaces such as pipes, radiators, ranges and refrigerators.** There is an increased risk of electric shock if your body is earthed or grounded.
- c) **Do not expose power tools to rain or wet conditions.** Water entering a power tool will increase the risk of electric shock.
- d) **Do not abuse the cord. Never use the cord for carrying, pulling or unplugging the power tool. Keep cord away from heat, oil, sharp edges or moving parts.** Damaged or entangled cords increase the risk of electric shock.
- e) **When operating a power tool outdoors, use an extension cord suitable for outdoor use.** Use of a cord suitable for outdoor use reduces the risk of electric shock.

## 3) Personal safety

- a) **Stay alert, watch what you are doing and use common sense when operating a power tool. Do not use a power tool while you are tired or under the influence of drugs, alcohol or medication.** A moment of inattention while operating power tools may result in serious personal injury.
- b) **Use safety equipment. Always wear eye protection.** Safety equipment such as dust mask, non-skid safety shoes, hard hat, or hearing protection used for appropriate conditions will reduce personal injuries.
- c) **Avoid accidental starting. Ensure the switch is in the off-position before plugging in.** Carrying power tools with your finger on the switch or plugging in power tools that have the switch on invites accidents.

## GENERAL SAFETY RULES continued

- d) **Remove any adjusting key or wrench before turning the power tool on.** A wrench or a key left attached to a rotating part of the power tool may result in personal injury.
- e) **Do not overreach. Keep proper footing and balance at all times.** This enables better control of the power tool in unexpected situations.
- f) **Dress properly. Do not wear loose clothing or jewelry. Keep your hair, clothing and gloves away from moving parts.** Loose clothes, jewelry or long hair can be caught in moving parts.
- g) **If devices are provided for the connection of dust extraction and collection facilities, ensure these are connected and properly used.** Use of these devices can reduce dust-related hazards.

### 4) Power tool use and care











- a) **Do not force the power tool. Use the correct power tool for your application.** The correct power tool will do the job better and safer at the rate for which it was designed.
- b) **Do not use the power tool if the switch does not turn it on and off.** Any power tool that cannot be controlled with the switch is dangerous and must be repaired.
- c) **Disconnect the plug from the power source before making any adjustments, changing accessories, or storing power tools.** Such preventive safety measures reduce the risk of starting the power tool accidentally.
- d) **Store idle power tools out of the reach of children and do not allow persons unfamiliar with the power tool or these instructions to operate the power tool.** Power tools are dangerous in the hands of untrained users.
- e) **Maintain power tools. Check for misalignment or binding of moving parts, breakage of parts and any other condition that may affect the power tools operation. If damaged, have the power tool repaired before use.** Many accidents are caused by poorly maintained power tools.
- f) **Keep cutting tools sharp and clean.** Properly maintained cutting tools with sharp cutting edges are less likely to bind and are easier to control.
- g) **Use the power tool, accessories and tool bits etc., in accordance with these instructions and in the manner intended for the particular type of power tool, taking into account the working conditions and the work to be performed.** Use of the power tool for operations different from those intended could result in a hazardous situation.

### 5) Service

- a) **Have your power tool serviced by a qualified repair person using only identical replacement parts.** This will ensure that the safety of the power tool is maintained.

## ADDITIONAL SPECIFIC SAFETY RULES

1. **Wait for the cutter to stop before setting the tool down.** An exposed cutter may engage the surface leading to possible loss of control and serious injury.
2. **Use clamps or other practical way to secure and support the workpiece to a stable platform.** Holding the work by hand or against your body is unstable and may lead to loss of control.
3. **Keep blades sharp.** Sharp blades will do the job better and safer.
4. **Keep hands away from cutting area.** When sawing never reach underneath or behind the material being cut for any reason.
5. **When you have finished a cut** be careful not to come into contact with the blade. Turn off the motor immediately.
6. **⚠ WARNING EXERCISE EXTREME CAUTION WHEN BLIND CUTTING TO BE CERTAIN THAT THERE ARE NO FOREIGN OBJECTS SUCH AS ELECTRICAL WIRE, CONDUIT, PLUMBING PIPES, ETC., THAT MAY COME IN CONTACT WITH THE BLADE.**
7. **Never hold work** in your hand, lap, or against other parts of your body when sawing.
8. **Wear eye and hearing protection. Always use safety glasses.** Everyday eyeglasses are NOT safety glasses. USE CERTIFIED SAFETY EQUIPMENT. Eye protection equipment should comply with ANSI Z87.1 standards. Hearing equipment should comply with ANSI S3.19 standards.
9. **⚠ WARNING Use of this tool can generate and disburse dust or other airborne particles, including wood dust, crystalline silica dust and asbestos dust.** Direct particles away from face and body. Always operate tool in well ventilated area and provide for proper dust removal. Use dust collection system wherever possible. Exposure to the dust may cause serious and permanent respiratory or other injury, including silicosis (a serious lung disease), cancer, and death. Avoid breathing the dust, and avoid prolonged contact with dust. Allowing dust to get into your mouth or eyes, or lay on your skin may promote absorption of harmful material. Always use properly fitting NIOSH/OSHA approved respiratory protection appropriate for the dust exposure, and wash exposed areas with soap and water.

<b>SYMBOL</b>	<b>DEFINITION</b>
V	volts
A	amperes
Hz	hertz
W	watts
kW	kilowatts
F	farads
$\mu$ F	microfarads
l	litres
g	grams
kg	kilograms
bar	bars
Pa	pascals
h	hours
min	minutes
s	seconds
$n_0$	no-load speed
.../min or ...min <sup>-1</sup>	Revolutions or reciprocations per minute
 or d.c.	direct current
 or a.c.	alternating current
2 	two-phase alternating current
2N 	two-phase alternating current with neutral
3 	three-phase alternating current
3N 	three-phase alternating current with neutral
 A	rated current of the appropriate fuse-link in amperes
	time-lag miniature fuse-link where X is the symbol for the time/current characteristic, as given in IEC 60127
	protective earth
	class II tool
IPXX	IP symbol

## MOTOR

Many Porter-Cable tools will operate on either D.C., or single phase 25 to 60 cycle A.C. current and voltage within plus or minus 5 percent of that shown on the specification plate on the tool. Several models, however, are designed for A.C. current only. Refer to the specification plate on your tool for proper voltage and current rating.

### CAUTION

Do not operate your tool on a current on which the voltage is not within correct limits. Do not operate tools rated A.C. only on D.C. current. To do so may seriously damage the tool.

## EXTENSION CORD SELECTION

If an extension cord is used, make sure the conductor size is large enough to prevent excessive voltage drop which will cause loss of power and possible motor damage. A table of recommended extension cord sizes will be found in this section. This table is based on limiting line voltage drop to 5 volts (10 volts for 230 volts) at 150% of rated amperes.

If an extension cord is to be used outdoors, it must be marked with the suffix W-A or W following the cord type designation. For example – SJTW-A to indicate it is acceptable for outdoor use.

RECOMMENDED EXTENSION CORD SIZES FOR USE WITH PORTABLE ELECTRIC TOOLS

		Length of Cord in Feet									
		115V	25 Ft.	50 Ft.	100 Ft.	150 Ft.	200 Ft.	250 Ft.	300 Ft.	400 Ft.	500 Ft.
		230V	50 Ft.	100 Ft.	200 Ft.	300 Ft.	400 Ft.	500 Ft.	600 Ft.	800 Ft.	1000 Ft.
Nameplate Ampere Rating	0-2	18	18	18	16	16	14	14	12	12	
	2-3	18	18	16	14	14	12	12	10	10	
	3-4	18	18	16	14	12	12	10	10	8	
	4-5	18	18	14	12	12	10	10	8	8	
	5-6	18	16	14	12	10	10	8	8	6	
	6-8	18	16	12	10	10	8	6	6	6	
	8-10	18	14	12	10	8	8	6	6	4	
	10-12	16	14	10	8	8	6	6	4	4	
	12-14	16	12	10	8	6	6	6	4	2	
	14-16	16	12	10	8	6	6	4	4	2	
	16-18	14	12	8	8	6	4	4	2	2	
18-20	14	12	8	6	6	4	4	2	2		

**SAVE THESE INSTRUCTIONS!**



## CARTON CONTENTS

- 1) Planer
- 2) Instruction Manual
- 3) Replacement Parts List
- 4) Combination Package

## FUNCTIONAL DESCRIPTION

### FOREWORD

Model 126 is a 7.0 amp, 22,000 RPM portable planer that can plane wood up to 2-13/32" wide and 3/32" deep.

## ASSEMBLY

**NOTE:** This tool is shipped completely assembled. No assembly time or tools are required.

## OPERATION

### TO INSTALL THE CUTTER

**▲WARNING** DISCONNECT THE TOOL FROM THE POWER SOURCE!

1. Turn the plane upside down on the bench so that it rests on the handle and motor housing.
2. Remove the rear cover retaining screw (A) Fig. 1 on the cutter housing and loosen the front screw (B), allowing the cover (C) to swing open.
3. When the cutter shaft (D) Fig. 1 is exposed, install the cutter (placing the slotted end first) and then the spacer. Place the nut on the end of the shaft. Insert a hex wrench in the end of the cutter shaft and hold it steady while tightening the nut with the blade wrench (Fig. 2). Tighten the nut securely.
4. Put the cover back into place and tighten the cover retaining screws.

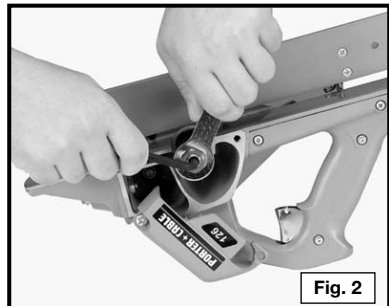
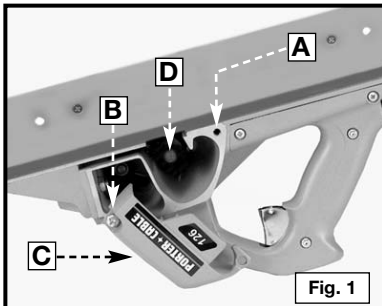

## ADJUSTING THE CUTTER

**⚠ WARNING** DISCONNECT THE TOOL FROM THE POWER SOURCE!

1. Set the cutter lever (B) Fig. 3 to the “zero” position to allow it to accurately gauge the depth of cut. Turn the plane over.

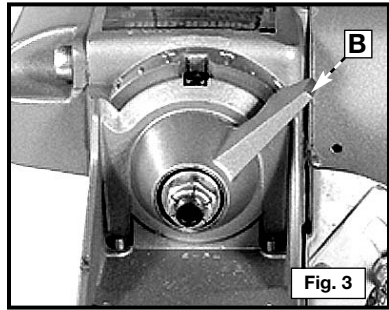

2. The cutter adjusting lever (C) Fig. 4 is located to the left of the handle directly behind the motor housing. Turn this lever to the position shown in Fig. 4.
3. Place a straight edge across the cutter opening (Fig. 5), so that it rests on both the front and rear shoe. Turn the cutter by hand until it lifts the straight edge to its maximum height. Adjust the lever (C) Fig. 4 until the top of the cutting edge just touches the straight edge while it rests evenly on both shoes. The cutter is set for “zero” cut.
4. Make this adjustment each time a new or re-sharpened cutter is installed in the plane.

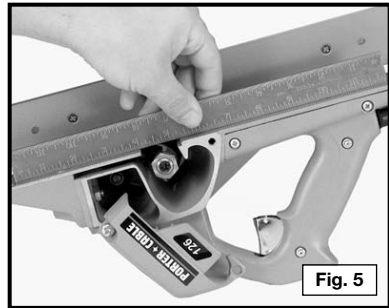
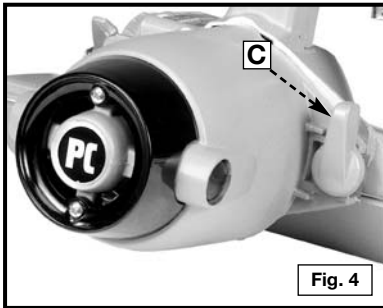

## ADJUSTING FOR DEPTH OF CUT

Adjust your depth of cut by moving the depth adjustment lever (D) Fig. 6. Each mark on the gauge represents 1/64". To plane 1/32" from a board or door, move the lever to the number “1” position. Make a 1/64" cut by setting the lever halfway between “0” and “1”. Make a 3/64" cut by setting the lever halfway between “1” and “2”. The plane has one other operating adjustment - the angle of the apron to the plane shoe. This adjustment consists of two graduated hinges held by wing nuts (E) Fig. 6. Both hinges should be on the same angle markings before the nuts are tightened.

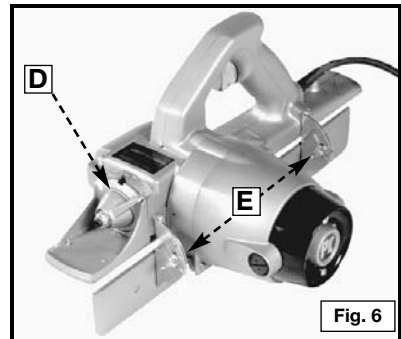

# HOW TO USE THE PORTA-PLANE®

## MAKING THE CUT

To provide maximum control of the tool, hold the planer with the right hand on the handle and the left hand on the front of the motor housing (Fig. 7). Rest the thumb on the depth adjusting lever and wrap the fingers around the motor housing.

The position of the plane on the work is important in obtaining optimum results. Hold the plane shoe and the apron firmly against the work. At the start of the cut, place the pressure on the front shoe.

After the plane has entered the work, put pressure on the rear shoe. Follow through with the plane to the end of the cut and continue the rear pressure until the cut is complete.

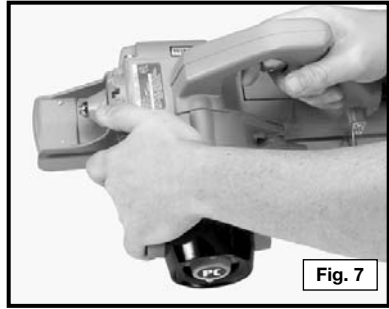

## BEVEL CUTTING

The plane may be quickly set for outside bevel cuts from 0 degrees to 15 degrees or inside bevel cuts from 0 degrees to 45 degrees. Make the bevel adjustment by loosening the two wing nuts (A) Fig. 8 on the apron hinges and tilting the apron (B) until the pointers on the hinges line up with the desired angle graduations. Tighten the wing nuts (A) securely. The beveled cuts are made the same as regular right-angle cuts. More than one pass may be necessary, depending on the width of the bevel. Keep the plane shoe and the apron pressed firmly against the work during the entire cut. Make each cut for the full length of the board.

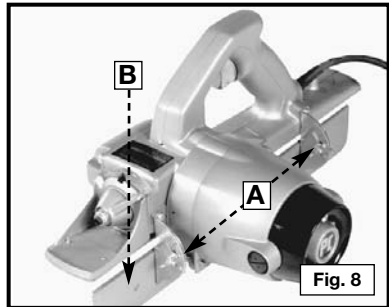

## APRON STOP STUD

The apron stop stud is located directly behind the front hinge of the apron (A) Fig. 9 and on the underside of the motor housing (B) Fig. 9, and is held in place by a screw. This stud is used to produce exact settings of the apron quickly for repeated cuts of the same angle.

Select the required setting of the apron and lock it in place with the thumb screws (A) Fig. 8. With a screwdriver, turn the screw and release the stud. Move the stud until the head rests against the side of the apron (Fig. 9). Tighten the screw. After this procedure, the apron can be adjusted to smaller angles and quickly re-set to the original angle by simply moving it back against the apron stop stud.

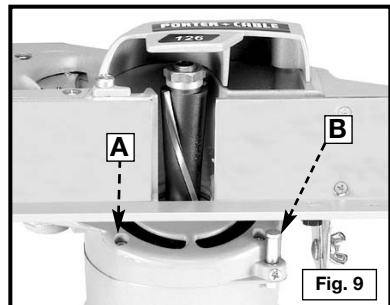

## FITTING A DOOR

Carefully fit doors to the jambs with ample clearance to ensure free movement. The 126 Plane is ideally suited for this job. New doors delivered from the supplier have squared edges along two sides (stiles), and lugs extending at the top and bottom beyond the rails. Plane the hinged side with a slight angle to the inside edge. Measure the width of the opening at top and bottom and transfer the dimensions to the door, marking from the hinge stile. Plane the lock stile 1/8" narrower than the door opening and with a bevel of about 10 degrees to the inside. Cut and plane the top and bottom rails 90 degrees. Remove all sharp edges on the door with a 1/64" cut and smooth with sandpaper.

## PLYWOOD EDGES

One major difficulty in finishing plywood is planing a smooth edge without breaking out the cross-grain ply at the corners. A piece of scrap can be tacked or clamped to the end so that the plane can run out its complete cut. The plane will give the best finish cut on all sizes and types of plywood, provided small amounts of material are removed with each pass. Set the depth graduation for only a slight advance each time a pass is made. When approaching the end of the pass, move the plane very slowly and put all the pressure on the rear shoe.

## PLANING AN UNEVEN BOARD

The fitting edge is not straight on many doors, screens, storm windows, baseboards, or other long edges. Mark the line carefully with a pencil and notice where the greatest amount of material must be removed. Start the plane with the depth adjusting lever set at "0" well behind the high spot. As the plane advances, advance the lever to cut deeper. When the high spot is passed, turn the lever back. Work down the length of the board or door edge working carefully to the pencil line. A true fit can be accomplished by this method provided the bow or bend is not too great. Uneven boards can have straight edges by working down high spots first and by cutting only 1/64" of material with each pass.

## ADJUSTMENTS

### ADJUSTING THE DEPTH-ADJUSTING LEVER TENSION

You should be able to move the tension lever easily with your thumb, but it should also be tight enough that it would be difficult to move it unintentionally.

**⚠ WARNING** DISCONNECT THE TOOL FROM THE POWER SOURCE!

Tighten or loosen the nut (A) Fig. 10 at the front of the depth adjusting lever until the right tension is found. Be sure that the lever is not too loose and can hold its setting for the full length of cut.

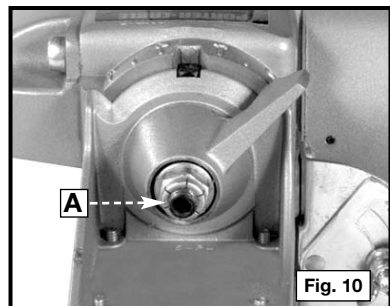

## ADJUSTING THE CUTTER-ADJUSTING LEVER TENSION

Each time the blade is sharpened, the plane must be reset to “0” so that the depth adjusting lever can accurately measure the depth of cut. If the cutter adjusting lever is too tight or too loose, adjust it immediately to the proper tension.

**⚠ WARNING**    **DISCONNECT THE TOOL FROM THE POWER SOURCE!**

Remove the five handle-cover retaining screws on the right side of the handle. Lift the handle cover to reach the cutter adjusting lever nut (A) Fig. 11. Tighten or loosen this nut until the lever's tension is sufficient to hold it securely in place. Attach the handle cover.

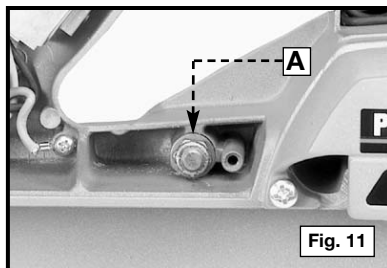

**⚠ WARNING**    **Do not pinch the wires!**

## TROUBLESHOOTING

For assistance with your tool, visit our website at [www.porter-cable.com](http://www.porter-cable.com) for a list of service centers or call the Porter-Cable help line at 1-800-487-8665.

# MAINTENANCE

## KEEP TOOL CLEAN

Periodically blow out all air passages with dry compressed air. All plastic parts should be cleaned with a soft damp cloth. NEVER use solvents to clean plastic parts. They could possibly dissolve or otherwise damage the material.

**▲WARNING** Wear ANSI Z87.1 safety glasses while using compressed air.

## FAILURE TO START

Should your tool fail to start, check to make sure the prongs on the cord plug are making good contact in the outlet. Also, check for blown fuses or open circuit breakers in the line.

## LUBRICATION

This tool has been lubricated with a sufficient amount of high grade lubricant for the life of the unit under normal operating conditions. No further lubrication is necessary.

## BRUSH INSPECTION (If applicable)

For your continued safety and electrical protection, brush inspection and replacement on this tool should ONLY be performed by an AUTHORIZED PORTER-CABLE SERVICE STATION or a PORTER-CABLE•DELTA FACTORY SERVICE CENTER.

At approximately 100 hours of use, take or send your tool to your nearest authorized Porter-Cable Service Station to be thoroughly cleaned and inspected. Have worn parts replaced and lubricated with fresh lubricant. Have new brushes installed, and test the tool for performance.

Any loss of power before the above maintenance check may indicate the need for immediate servicing of your tool. DO NOT CONTINUE TO OPERATE TOOL UNDER THIS CONDITION. If proper operating voltage is present, return your tool to the service station for immediate service.

## SERVICE

### REPLACEMENT PARTS

When servicing use only identical replacement parts. For a service parts list or to learn more about Porter-Cable visit our website at [www.porter-cable.com](http://www.porter-cable.com).

### SERVICE AND REPAIRS

All quality tools will eventually require servicing, or replacement of parts due to wear from normal use. For assistance with your tool, visit our website at [www.porter-cable.com](http://www.porter-cable.com) for a list of service centers or call the Customer Care Department at 1-800-487-8665. All repairs made by our service centers are fully guaranteed against defective material and workmanship. We cannot guarantee repairs made or attempted by others.

Should you have any questions about your tool, feel free to write us at any time. In any communications, please give all information shown on the nameplate of your tool (model number, type, serial number, etc.).

## ACCESSORIES

A complete line of accessories is available from your Porter-Cable® Delta Supplier, Porter-Cable® Delta Factory Service Centers, and Porter-Cable Authorized Service Stations. Please visit our Web Site [www.porter-cable.com](http://www.porter-cable.com) for a catalog or for the name of your nearest supplier.

**⚠ WARNING** Since accessories other than those offered by Porter-Cable•Delta have not been tested with this product, use of such accessories could be hazardous. For safest operation, only Porter-Cable•Delta recommended accessories should be used with this product.

## **WARRANTY**

To register your tool for warranty service visit our website at **[www.porter-cable.com](http://www.porter-cable.com)**.

### **PORTER-CABLE LIMITED ONE YEAR WARRANTY**

Porter-Cable warrants its Professional Power Tools for a period of one year from the date of original purchase. We will repair or replace at our option, any part or parts of the product and accessories covered under this warranty which, after examination, proves to be defective in workmanship or material during the warranty period. For repair or replacement return the complete tool or accessory, transportation prepaid, to your nearest Porter-Cable Service Center or Authorized Service Station. Proof of purchase may be required. This warranty does not apply to repair or replacement required due to misuse, abuse, normal wear and tear or repairs attempted or made by other than our Service Centers or Authorized Service Stations.

ANY IMPLIED WARRANTY, INCLUDING THE IMPLIED WARRANTIES OF MERCHANTABILITY AND FITNESS FOR A PARTICULAR PURPOSE, WILL LAST ONLY FOR ONE (1) YEAR FROM THE DATE OF PURCHASE.

To obtain information on warranty performance please write to: PORTER-CABLE, 4825 Highway 45 North, Jackson, Tennessee 38305; Attention: Product Service. THE FOREGOING OBLIGATION IS PORTER-CABLE'S SOLE LIABILITY UNDER THIS OR ANY IMPLIED WARRANTY AND UNDER NO CIRCUMSTANCES SHALL PORTER-CABLE BE LIABLE FOR ANY INCIDENTAL OR CONSEQUENTIAL DAMAGES. Some states do not allow limitations on how long an implied warranty lasts or the exclusion or limitation of incidental or consequential damages, so the above limitation or exclusion may not apply to you.

This warranty gives you specific legal rights and you may also have other legal rights which vary from state to state.