

ESPAÑOL: PÁGINA 17
FRANÇAISE : PAGE 35

Instruction manual

Routers



MODEL 690

MODEL 6931

IMPORTANT

Please make certain that the person who is to use this equipment carefully reads and understands these instructions before starting operations.

The Model and Serial No. plate is located on the main housing of the tool. Record these numbers in the spaces below and retain for future reference.

Model No. _____

Type _____

Serial No. _____

To learn more about Porter-Cable visit our website at:

<http://www.porter-cable.com>

PORTER-CABLE
PROFESSIONAL POWER TOOLS

Copyright © 2001 Porter-Cable Corporation

Part No. 899749 - 11-30-01

⚠ WARNING: SOME DUST CREATED BY POWER SANDING, SAWING, GRINDING, DRILLING, AND OTHER CONSTRUCTION ACTIVITIES

contains chemicals known to cause cancer, birth defects or other reproductive harm. Some examples of these chemicals are:

- lead from lead-based paints,
- crystalline silica from bricks and cement and other masonry products, and
- arsenic and chromium from chemically-treated lumber.

Your risk from these exposures varies, depending on how often you do this type of work. To reduce your exposure to these chemicals: work in a well ventilated area, and work with approved safety equipment, such as those dust masks that are specially designed to filter out microscopic particles.

GENERAL SAFETY RULES

⚠ WARNING: READ AND UNDERSTAND ALL INSTRUCTIONS. Failure to follow all instructions listed below, may result in electric shock, fire and/or serious personal injury.

SAVE THESE INSTRUCTIONS.

WORK AREA

1. **Keep your work area clean and well lit.** Cluttered benches and dark areas invite accidents.
2. **Do not operate power tools in explosive atmospheres, such as in the presence of flammable liquids, gases, or dust.** Power tools create sparks which may ignite the dust or fumes.
3. **Keep bystanders, children, and visitors away while operating a power tool.** Distractions can cause you to lose control.

ELECTRICAL SAFETY

1. **Grounded tools must be plugged into an outlet properly installed and grounded in accordance with all codes and ordinances. Never remove the grounding prong or modify the plug in any way. Do not use any adapter plugs. Check with a qualified electrician if you are in doubt as to whether the outlet is properly grounded.** If the tools should electrically malfunction or break down, grounding provides a low resistance path to carry electricity away from the user.
2. **Avoid body contact with grounded surfaces such as pipes, radiators, ranges and refrigerators.** There is an increased risk of electric shock if your body is grounded.
3. **Don't expose power tools to rain or wet conditions.** Water entering a power tool will increase the risk of electric shock.
4. **Do not abuse the cord. Never use the cord to carry the tools or pull the plug from an outlet. Keep cord away from heat, oil, sharp edges or moving parts. Replace damaged cords immediately.** Damaged cords increase the risk of electric shock.
5. **When operating a power tool outside, use an outdoor extension cord marked "W-A" or "W".** These cords are rated for outdoor use and reduce the risk of electric shock.

PERSONAL SAFETY

1. **Stay alert, watch what you are doing, and use common sense when operating a power tool. Do not use tool while tired or under the influence of drugs, alcohol, or medication.** A moment of inattention while operating power tools may result in serious personal injury.
2. **Dress properly. Do not wear loose clothing or jewelry. Contain long**

hair. Keep your hair, clothing, and gloves away from moving parts. Loose clothes, jewelry, or long hair can be caught in moving parts.

3. Avoid accidental starting. Be sure switch is OFF before plugging in. Carrying tools with your finger on the switch or plugging in tools that have the switch ON invites accidents.

4. Remove adjusting keys or wrenches before turning the tool ON. A wrench or a key that is left attached to a rotating part of the tool may result in personal injury.

5. Do not overreach. Keep proper footing and balance at all times. Proper footing and balance enable better control of the tool in unexpected situations.

6. Use safety equipment. Always wear eye protection. Dust mask, non-skid safety shoes, hard hat, or hearing protection must be used for appropriate conditions.

TOOLS USE AND CARE

1. Use clamps or other practical way to secure and support the workpiece to a stable platform. Holding the work by hand or against your body is unstable and may lead to loss of control.

2. Do not force tool. Use the correct tool for your application. The correct tool will do the job better and safer at the rate for which it is designed.

3. Do not use tool if switch does not turn it ON or OFF. A tool that cannot be controlled with the switch is dangerous and must be repaired.

4. Disconnect the plug from the power source before making any adjustments, changing accessories, or storing the tool. Such preventive safety measures reduce the risk of starting the tool accidentally.

5. Store idle tools out of reach of children and other untrained persons. Tools are dangerous in the hands of untrained users.

6. Maintain tools with care. Keep cutting tools sharp and clean. Properly maintained tools, with sharp cutting edges are less likely to bind and are easier to control.

7. Check for misalignment or binding of moving parts, breakage of parts, and any other condition that may affect the tool's operation. If damaged, have the tool serviced before using. Many accidents are caused by poorly maintained tools.

8. Use only accessories that are recommended by the manufacturer for your model. Accessories that may be suitable for one tool may become hazardous when used on another tool.

SERVICE

1. Tool service must be performed only by qualified repair personnel. Service or maintenance performed by unqualified personnel may result in a risk of injury.

2. When servicing a tool, use only identical replacement parts. Follow instructions in the Maintenance Section of this manual. Use of unauthorized parts or failure to follow Maintenance Instructions may create a risk of electric shock or injury.









SPECIFIC SAFETY RULES AND SYMBOLS FOR ROUTERS

1. HOLD TOOL BY INSULATED GRIPPING SURFACES WHEN PERFORMING AN OPERATION WHERE THE CUTTING TOOL MAY CONTACT HIDDEN WIRING OR ITS OWN CORD. Contact with a "live" wire will also make exposed metal parts of the tool "live" and shock the operator.

2. **NEVER ADJUST** depth of cut while motor is running. A slip at this time may cause personal injury, or damage to cutter or workpiece.
3. **BE SURE** cord is free and will not "hang up" during routing operations.
4. **KEEP HANDS CLEAR** of cutter when motor is running to prevent personal injury.
5. **MAINTAIN FIRM GRIP** on router when starting motor to resist starting torque.
6. **STAY ALERT** and keep cutter clear of all foreign objects while motor is running.
7. **BE SURE** motor has completely stopped before setting machine down between operations.
8. **DO NOT** use router bits with a diameter in excess of 2¹/₈" in this machine.
9. **DO NOT** use router hand-held in an upside-down or a horizontal position. Motor can fall from base if not properly attached according to instructions.
10. **AVOID "CLIMB-CUTTING"**. "Climb-cutting" increases the chance for loss of control resulting in possible personal injury.
11. **NEVER TOUCH** router bits after use, as they may be extremely hot.
12. **BE SURE** bit is centered in templet guide prior to templet guide applications to avoid personal injury or damage to finished work.
13. **DO NOT USE ROUTER MOTOR** without the router base installed, loss of control could result, causing personal injury or damage to work.
14. **SOME WOOD CONTAINS PRESERVATIVES WHICH CAN BE TOXIC.** Take extra care to prevent inhalation and skin contact when working with these materials. Request, and follow, any safety information available from your material supplier.
15. **⚠ WARNING:** There are certain applications for which this tool was designed. Porter-Cable strongly recommends that this tool NOT be modified and/or used for any application other than for which it was designed. If you have any questions relative to its application DO NOT use the tool until you have written Porter-Cable and we have advised you.

Technical Service Manager
Porter-Cable Corporation
4825 Highway 45 North
Jackson, TN 38305

SYMBOL	DEFINITION
V	volts
A	amperes
Hz	hertz
W	watts
kW	kilowatts
μF	microfarads
l	liters
kg	kilograms
N/cm ²	newtons per square centimeter
Pa	pascals
h	hours
min	minutes
s	seconds

-  alternating current
- 3  three-phase alternating current
- 3N  three-phase alternating current with neutral
-  direct current
- n_0  no load
-  alternating or direct current
-  Class II Construction
-  splash-proof construction
-  watertight construction
- .../min revolutions or reciprocation per minute

REPLACEMENT PARTS

When servicing use only identical replacement parts.

MOTOR

Many Porter-Cable tools will operate on either D.C., or single phase 25 to 60 cycle A.C. current and voltage within plus or minus 5 percent of that shown on the specification plate on the tool. Several models, however, are designed for A.C. current only. Refer to the specification plate on your tool for proper voltage and current rating.

CAUTION: Do not operate your tool on a current on which the voltage is not within correct limits. Do not operate tools rated A.C. only on D.C. current. To do so may seriously damage the tool.

EXTENSION CORD SELECTION

If an extension cord is used, make sure the conductor size is large enough to prevent excessive voltage drop which will cause loss of power and possible motor damage. A table of recommended extension cord sizes will be found in this section. This table is based on limiting line voltage drop to 5 volts (10 volts for 230 volts) at 150% of rated amperes.

If an extension cord is to be used outdoors it must be marked with the suffix W-A or W following the cord type designation. For example – SJTW-A to indicate it is acceptable for outdoor use.

RECOMMENDED EXTENSION CORD SIZES FOR USE WITH PORTABLE ELECTRIC TOOLS

		Length of Cord in Feet									
		115V	25 Ft.	50 Ft.	100 Ft.	150 Ft.	200 Ft.	250 Ft.	300 Ft.	400 Ft.	500 Ft.
Nameplate Ampere Rating	230V	50 Ft.	100 Ft.	200 Ft.	300 Ft.	400 Ft.	500 Ft.	600 Ft.	800 Ft.	1000 Ft.	
	0-2	18	18	18	16	16	14	14	12	12	
	2-3	18	18	16	14	14	12	12	10	10	
	3-4	18	18	16	14	12	12	10	10	8	
	4-5	18	18	14	12	12	10	10	8	8	
	5-6	18	16	14	12	10	10	8	8	6	
	6-8	18	16	12	10	10	8	6	6	6	
	8-10	18	14	12	10	8	8	6	6	4	
	10-12	16	14	10	8	8	6	6	4	4	
	12-14	16	12	10	8	6	6	6	4	2	
	14-16	16	12	10	8	6	6	4	4	2	
	16-18	14	12	8	8	6	4	4	2	2	
18-20	14	12	8	6	6	4	4	2	2		

FUNCTIONAL DESCRIPTION

FOREWORD

Porter-Cable routers are designed for continuous, rugged operation to handle the most demanding production applications.

SELECTING THE BIT

Model 693 is furnished with $1/4$ " and $1/2$ " diameter collets that will accommodate bits with $1/4$ " or $1/2$ " diameter shanks that are installed directly into the power unit collet. An accessory collet is available that will allow the use of bits having $3/8$ " diameter shanks.

CAUTION: Do not use router bits with a diameter in excess of $2 1/8$ " in this machine.

CAUTION: While preparing the router for use, while making adjustments and when router is not in use, ALWAYS disconnect it from the power source.

ASSEMBLY

1001 BASE

INSTALLING AND REMOVING THE BIT

1. **CAUTION:** DISCONNECT TOOL FROM POWER SOURCE.
2. Remove motor unit from base unit as follows:
 - (a) Loosen clamp screw (A) Fig. 1.
 - (b) While holding base, turn motor unit COUNTERCLOCKWISE until lower pin (B) in motor housing is disengaged from groove in base.
 - (c) Lift motor unit free from base unit.

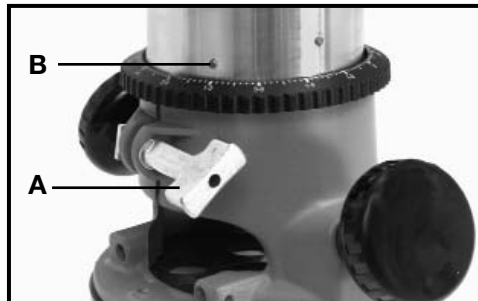

Fig. 1

3. Clean and insert shank of bit into collet until shank bottoms. Then back it out approximately $1/16$ ".
4. Lay motor unit on its side on bench with the collet pointing AWAY from you.
5. Place one wrench on flats on chuck with the opposite end of the wrench resting on the bench to your left, Fig. 2.
6. Place other wrench on collet and tighten COUNTERCLOCKWISE as shown in Fig. 2. TIGHTEN FIRMLY.
7. To remove the bit, reverse the foregoing procedure.

AVOID POSSIBLE DAMAGE TO COLLET. NEVER TIGHTEN COLLET WITHOUT BIT.

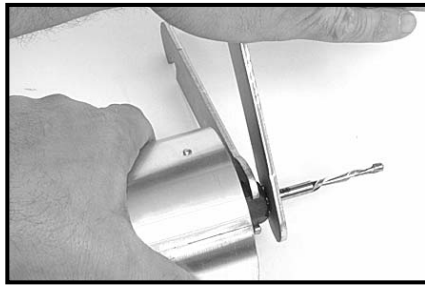

Fig. 2

ASSEMBLING THE MOTOR IN THE ROUTER BASE

1. **CAUTION:** DISCONNECT TOOL FROM POWER SOURCE.
2. Loosen the clamp screw (A) Fig. 1 to allow the power unit to be set in the base unit.
3. Insert motor unit into base aligning lower pin (B) with groove in base.
4. Rotate motor unit **CLOCKWISE** into base until upper guide pins are rigidly set in the groove of the base.
5. Tighten clamp screw firmly.

ADJUSTING DEPTH OF CUT

1. **CAUTION:** DISCONNECT TOOL FROM POWER SOURCE.
2. Loosen clamp screw (A), Fig. 3.
3. While holding base (E), turn motor unit (F), Fig. 3, **COUNTERCLOCKWISE** until the tip of the bit is above bottom surface of base.
4. Set router on flat wood surface.
5. Turn motor unit (F), Fig. 3, **CLOCKWISE** until bit touches the wood surface.
6. Tighten clamp screw (A), Fig. 3.
7. Rotate depth adjusting ring (B), Fig. 3, until the zero-line (C) is opposite the index line (D) on the housing.
8. Loosen clamp screw (A), Fig. 3.

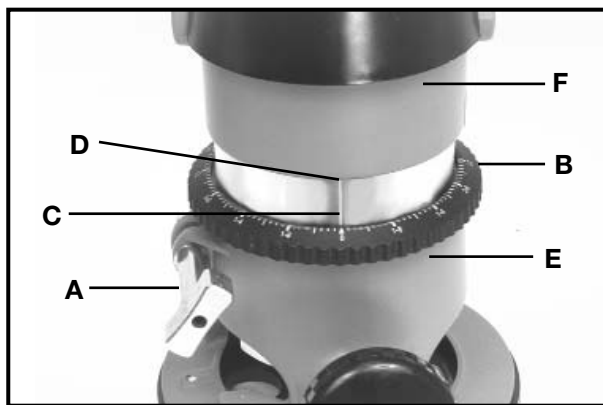

Fig. 3

9. Tip the router so bit is clear of the wood surface. Turn motor unit (F), Fig. 3 CLOCKWISE until the index line (D) on the motor housing reaches the desired depth indicated on the ring.
10. Tighten clamp screw (A), Fig. 3 firmly.

NOTE: Setting the index line to $\frac{1}{4}$ " on the ring means the cutting edge of the bit is exposed $\frac{1}{4}$ " below the base.

ADJUSTING SUBBASE ALIGNMENT

Applications using a templet guide require the bit to be centered within the guide. This, in turn, requires the center hole in the subbase to be in line with the collet of the motor unit. Your model has an adjustable subbase which has been aligned at the factory. If the subbase has been removed and/or readjustment is required, proceed as follows:

CAUTION: Be sure power switch is in "OFF" position and tool is disconnected from power source to avoid accidental starting of motor which could result in personal injury.

1. Loosen subbase mounting screws just enough to allow subbase to move on base.
2. Loosen clamp screw (see Fig. 4), and adjust motor so that the collet nut engages the center hole in the subbase. Allow the subbase to center itself on the collet nut. Tighten clamp screw.
3. Tighten subbase mounting screws securely.

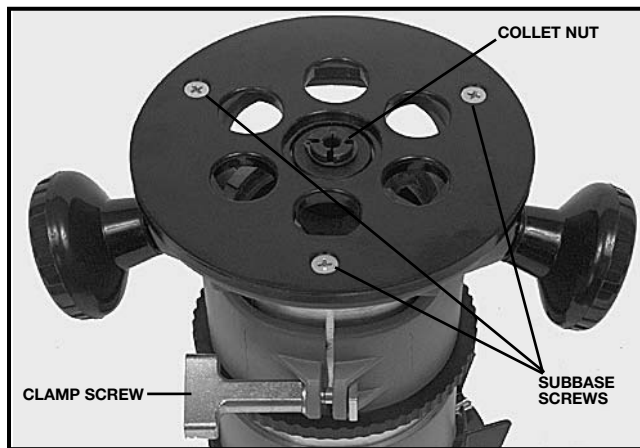

Fig. 4

6931 BASE

INSTALLING MOTOR IN PLUNGE BASE

1. **CAUTION:** DISCONNECT TOOL FROM POWER SOURCE.
2. Support clamp (see Fig. 5) and loosen motor clamp screw approximately $\frac{1}{2}$ ", with allen wrench (furnished).
3. Insert motor unit into base with switch positioned at front of left handle (see rear view in Fig. 6), and align the four pins (A) Fig. 6, in the motor case with the slots (B) Fig. 6, in the base.
4. Seat motor in base and tighten clamp screw to secure.

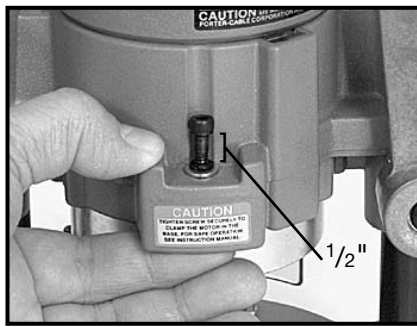

Fig. 5

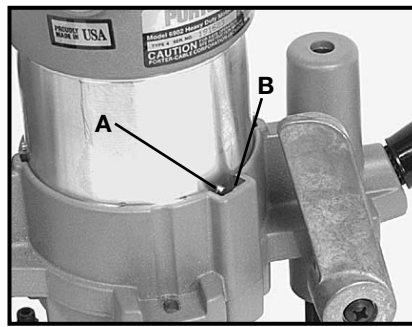

Fig. 6

REMOVING MOTOR FROM PLUNGE BASE

1. **CAUTION:** DISCONNECT TOOL FROM POWER SOURCE.
2. Remove clamp screw, flat washer, lock washer, and clamp locking nut.
3. Insert allen wrench (A) Fig. 7, as shown, to contact locking plate. Tap lightly to release and remove locking plate.
4. Slide motor out of base.
5. Reassemble clamp screw, lock washer, flat washer, locking plate and clamp locking nut to base and tighten lightly to prevent loss.

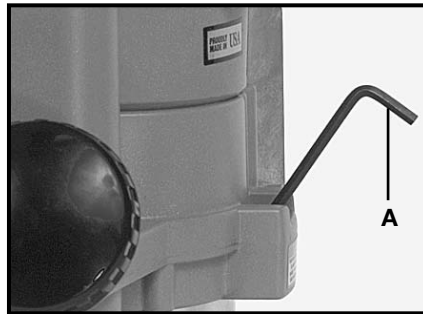

Fig. 7

INSTALLING AND REMOVING THE BIT

CAUTION: Be sure power switch is in the OFF position and tool is disconnected from power source to avoid accidental starting of motor which could result in personal injury.

1. Stand router upside down on its motor cap (see Fig. 8).
2. Clean and insert shank of bit into collet until shank bottoms. Then back it out approximately $\frac{1}{16}$ ".
3. Place one wrench on flats on chuck and one wrench on collet nut (see Fig. 8). Tighten firmly.

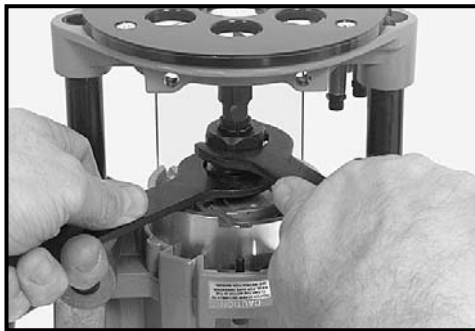

Fig. 8

DO NOT ALLOW WRENCHES TO CONTACT COLUMNS (A) Fig. 9, AS COLUMNS MAY BE DAMAGED, RESTRICTING PLUNGE ACTION.

NEVER TIGHTEN COLLET NUT WITHOUT BIT INSERTED. TO DO SO MAY DAMAGE COLLET.

4. To remove bit, reverse the foregoing procedure. If bit does not remove easily, tap the collet nut with wrench to release bit.

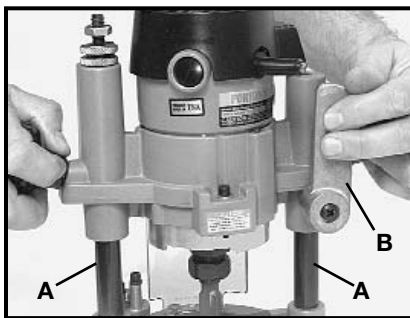

Fig. 9

ADJUSTING PLUNGE BASE

1. **CAUTION: DISCONNECT TOOL FROM POWER SOURCE.**
2. Loosen depth rod locking knob (A) Fig. 10, and depth indicator knob (D) Fig. 10, allowing the depth rod (E) Fig. 10, to contact one of the turret stops (B) Fig. 10.

Normally the deepest desired cut is set with the depth rod resting on the shortest turret stop (A) Fig. 11. The other two fixed stops then provide reduced cutting depths of $\frac{1}{4}$ " and $\frac{1}{2}$ " respectively. The three adjustable stops may be adjusted to any desired height. Any combination of fixed and/or adjustable stops may be utilized to achieve the desired depths required for a particular job.

3. Release plunge mechanism by pulling the locking lever (B) Fig. 9, to the left and lower plunge mechanism until the router bit just touches the work surface. Release lever and push to the right to lock mechanism in this position.

4. Tighten depth rod locking knob.
5. Position depth indicator (C) Fig. 10, at "0" position and tighten knob.
6. Loosen depth rod locking knob and raise depth rod until indicator aligns with the graduation representing the desired depth of plunge. (The example in Fig. 12 shows setting for 1" plunge.)

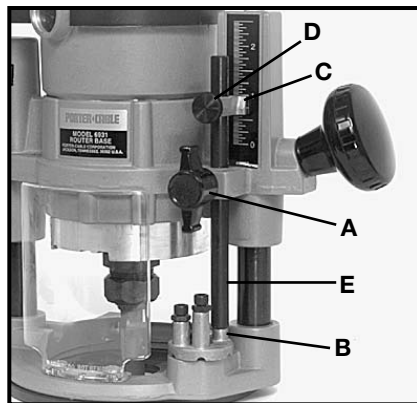

Fig. 10

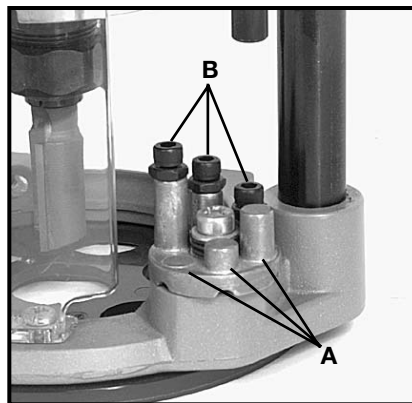

Fig. 11

7. Turn lower travel limiting nut until it is approximately $\frac{1}{4}$ " above the top of the plunge housing (see Fig. 13). While holding lower nut, turn upper nut until it "jams" against the lower nut.

CAUTION: The travel limiting nuts must always be "jammed" together to prevent movement (caused by vibration) which could prevent full bit retraction.

CAUTION: The travel limiting nuts must always be set so that bit can be retracted into base of router, clear of work.

DO NOT attempt to increase plunge travel by readjusting the stop nut. Increasing the travel beyond $2\frac{1}{2}$ " can cause mechanism to jam.

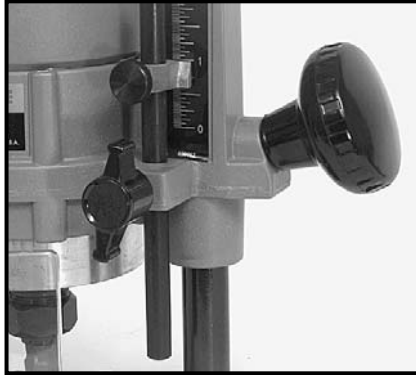

Fig. 12

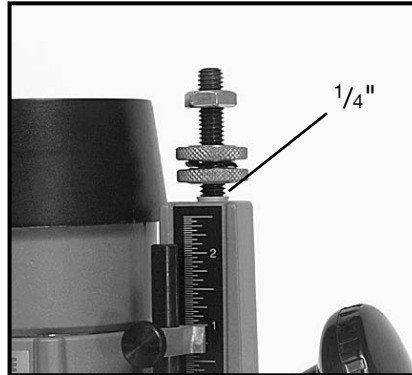

Fig. 13

ADJUSTING PLUNGE LOCKING LEVER

The plunge locking mechanism may be adjusted to compensate for wear or to reposition lever (in locked position). To adjust:

1. **CAUTION:** DISCONNECT TOOL FROM POWER SOURCE.
2. While holding lever in upright position (see Fig. 14). Remove retaining screw. Continue to hold lever through remaining steps.
3. Insert $\frac{1}{8}$ " allen wrench (A) Fig. 15, (not furnished) into adjustment screw and turn counterclockwise approximately $\frac{1}{2}$ turn.
4. Move lever to desired locked position and tighten adjustment screw.
5. Remove allen wrench and replace retaining screw.

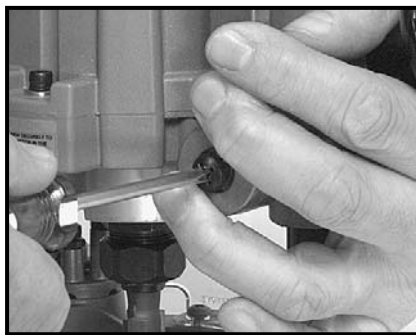

Fig. 14

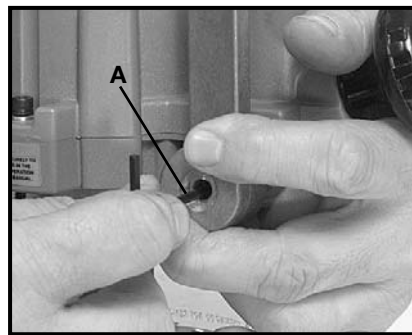

Fig. 15

OPERATION

CONNECTING TO POWER SOURCE

CAUTION: Before connecting router to power source, ALWAYS MAKE SURE SWITCH IS IN THE "OFF" POSITION. Also check that the power circuit is the same as that shown on specification plate of the router.

STARTING AND STOPPING THE MOTOR

CAUTION: Before starting the router make sure bit is clear of workpiece and foreign objects. Also keep firm grip on router to resist starting torque.

The motor is started and stopped by setting the toggle switch (A) Fig. 16 to "ON" or "OFF" position.

CAUTION: To avoid personal injury or damage to finished work always allow the motor to come to a COMPLETE STOP before setting it down.

CAUTION: When through-cutting, be sure there is clearance under workpiece for router bit.

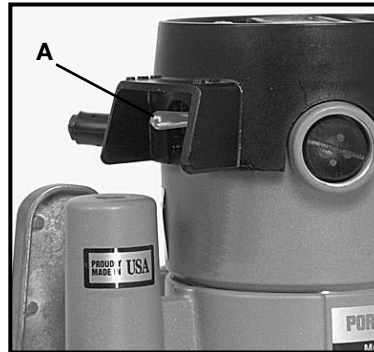

Fig. 16

USING THE ROUTER

IMPORTANT: Before using your router, consider the kind and total amount of material to be removed. Depending on the material, it may be necessary to make more than one cut to avoid overloading the motor. Before beginning the cut on the actual workpiece, it is advisable to make a sample cut on a piece of scrap lumber. This will show exactly how the cut will look as well as enable you to check dimensions.

CAUTION: Always be sure the work is rigidly clamped or otherwise secured before making a cut.

Generally speaking, when working on a bench, the workpiece should be held on the bench by wood clamps. When routing edges, the router should be held firmly down and against the work by both guiding knobs.

Since the cutter rotates clockwise (when viewing router from top), the router should be moved from left to right as you stand facing the work. When working on the inside of a templet, move router in clockwise direction.

When working on the outside of a templet, move router in a counter clockwise direction.

⚠ WARNING: Avoid "Climb-Cutting" (cutting in direction opposite that shown in Fig. 17), "Climb-Cutting" increases the chance for loss of control resulting in possible personal injury. When "Climb-Cutting" is required (backing around a corner), exercise extreme caution to maintain control of router.

The speed and depth of cut will depend largely on the type of material being worked upon. Keep the cutting pressure constant but do not crowd the router so the motor speed slows excessively. It may be necessary on exceptionally hard woods or problem materials to make more than one pass at various settings to get the desired depth of cut.

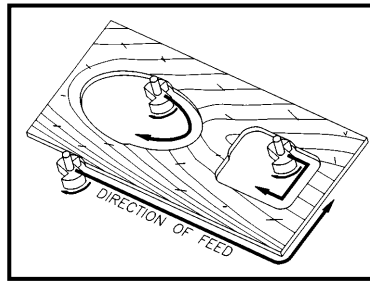

Fig. 17

When making cuts on all four edges of the workpiece, it is advisable to have the first cut on the end of the piece across the grain. Thus, if chipping of wood occurs at the end of a cut, it will be removed when making the next cut parallel with the grain.

Periodically wipe columns clean with a dry cloth. DO NOT lubricate columns.

THE EDGE GUIDE

An edge guide is available as an accessory to aid in routing operations such as: straight edge planing, parallel grooving, dado or slotting operations.

To assemble, insert guide rods (A) in holes in base, Fig. 18, and secure with screws (B). The guide (C) is adjusted on the rods and secured in desired position with thumb screws (D).

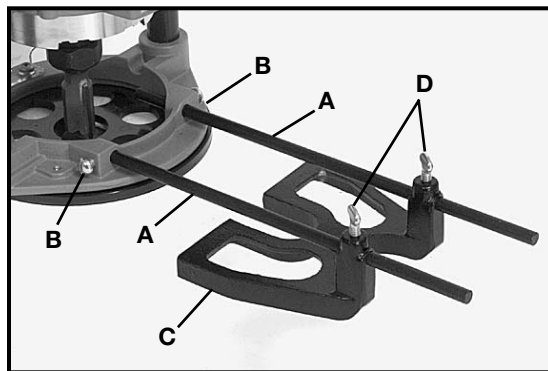

Fig. 18

TEMPLET GUIDES

A wide variety of templet guides are available for use in pattern and templet routing operations, Fig. 19 shows a typical combination bit, templet guide, and locknut.

CAUTION: DISCONNECT TOOL FROM POWER SOURCE.

To install, insert templet guide in center hole in router base and secure in place with the locknut.

BEFORE CONNECTING ROUTER TO POWER SOURCE. Install bit, adjust depth of cut, and rotate router chuck by hand to be sure bit or collet do not contact templet guide.

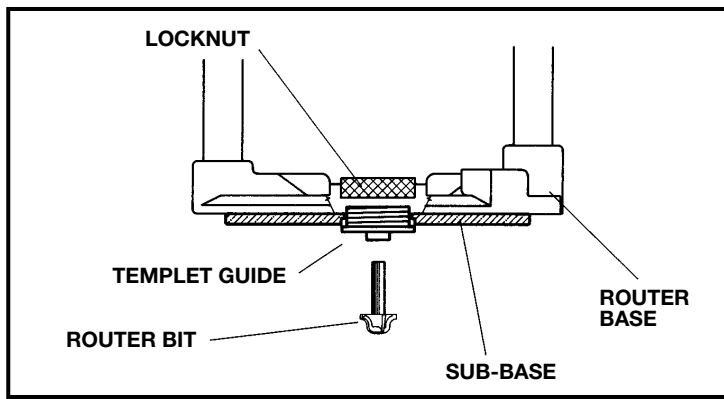

Fig. 19

MAINTENANCE

KEEP TOOL CLEAN

Periodically blow out all air passages with dry compressed air. All plastic parts should be cleaned with a soft damp cloth. NEVER use solvents to clean plastic parts. They could possibly dissolve or otherwise damage the material.

CAUTION: Wear safety glasses while using compressed air.

FAILURE TO START

Should your tool fail to start, check to make sure the prongs on the cord plug are making good contact in the outlet. Also, check for blown fuses or open circuit breakers in the line.

LUBRICATION

This tool has been lubricated with a sufficient amount of high grade lubricant for the life of the unit under normal operating conditions. No further lubrication is necessary.

BRUSH INSPECTION AND LUBRICATION

For your continued safety and electrical protection, brush inspection and replacement on this tool should ONLY be performed by an AUTHORIZED PORTER-CABLE SERVICE STATION or a PORTER-CABLE/DELTA FACTORY SERVICE CENTER.

At approximately 100 hours of use, take or send your tool to your nearest authorized Porter-Cable Service Station to be thoroughly cleaned and inspected. Have worn parts replaced and lubricate with fresh lubricant. Have new brushes installed, and test the tool for performance.

Any loss of power before the above maintenance check may indicate the need for immediate servicing of your tool. DO NOT CONTINUE TO OPERATE TOOL UNDER THIS CONDITION. If proper operating voltage is present, return your tool to the service station for immediate service.

SERVICE AND REPAIRS

All quality tools will eventually require servicing or replacement of parts due to wear from normal use. These operations, including brush inspection and replacement, should ONLY be performed by either an AUTHORIZED PORTER-CABLE SERVICE STATION or a PORTER-CABLE/DELTA FACTORY SERVICE CENTER. All repairs made by these agencies are fully guaranteed against defective material and workmanship. We cannot guarantee repairs made or attempted by anyone other than these agencies.

Should you have any questions about your tool, feel free to write us at any time. In any communications, please give all information shown on the nameplate of your tool (model number, type, serial number, etc.).

ACCESSORIES

A complete line of accessories is available from your Porter-Cable • Delta Supplier, Porter-Cable • Delta Factory Service Centers, and Porter-Cable Authorized Service Stations. Please visit our Web Site www.porter-cable.com for a catalog or for the name of your nearest supplier.

 **WARNING:** Since accessories other than those offered by Porter-Cable • Delta have not been tested with this product, use of such accessories could be hazardous. For safest operation, only Porter-Cable • Delta recommended accessories should be used with this product.

PORTER-CABLE LIMITED ONE YEAR WARRANTY

Porter-Cable warrants its Professional Power Tools for a period of one year from the date of original purchase. We will repair or replace at our option, any part or parts of the product and accessories covered under this warranty which, after examination, proves to be defective in workmanship or material during the warranty period. For repair or replacement return the complete tool or accessory, transportation prepaid, to your nearest Porter-Cable Service Center or Authorized Service Station. Proof of purchase may be required. This warranty does not apply to repair or replacement required due to misuse, abuse, normal wear and tear or repairs attempted or made by other than our Service Centers or Authorized Service Stations.

ANY IMPLIED WARRANTY, INCLUDING THE IMPLIED WARRANTIES OF MERCHANTABILITY AND FITNESS FOR A PARTICULAR PURPOSE, WILL LAST ONLY FOR ONE (1) YEAR FROM THE DATE OF PURCHASE.

To obtain information on warranty performance please write to: PORTER-CABLE CORPORATION, 4825 Highway 45 North, Jackson, Tennessee 38305; Attention: Product Service. THE FOREGOING OBLIGATION IS PORTER-CABLE'S SOLE LIABILITY UNDER THIS OR ANY IMPLIED WARRANTY AND UNDER NO CIRCUMSTANCES SHALL PORTER-CABLE BE LIABLE FOR ANY INCIDENTAL OR CONSEQUENTIAL DAMAGES. Some states do not allow limitations on how long an implied warranty lasts or the exclusion or limitation of incidental or consequential damages, so the above limitation or exclusion may not apply to you.

This warranty gives you specific legal rights and you may also have other legal rights which vary from state to state.

**PORTER-CABLE • DELTA SERVICE CENTERS
(CENTROS DE SERVICIO DE PORTER-CABLE • DELTA)
(CENTRE DE SERVICE PORTER-CABLE • DELTA)**

**Parts and Repair Service for Porter-Cable • Delta Power Tools are Available at These Locations
(Obtenga Refaccion de Partes o Servicio para su Herramienta en los Sigüientes Centros de Porter-Cable • Delta)
(Locations où vous trouvez les pièces de rechange nécessaires ainsi qu'un service d'entretien)**

<p>ARIZONA Tempe 85282 (Phoenix) 2400 West Southern Avenue Suite 105 Phone: (602) 437-1200 Fax: (602) 437-2200</p>	<p>ILLINOIS Addison 60101 (Chicago) 311 Laura Drive Phone: (630) 628-6100 Fax: (630) 628-0023</p>	<p>MINNESOTA Cleveland 44125 8001 Sweet Valley Drive Unit #19 Phone: (216) 447-9030 Fax: (216) 447-3097</p>	<p>OREGON Portland 97230 4916 NE 122 nd Ave. Phone: (503) 252-0107 Fax: (503) 252-2123</p>
<p>CALIFORNIA Ontario 91761 (Los Angeles) 3949A East Guasti Road Phone: (909) 390-5555 Fax: (909) 390-5554</p>	<p>MISSOURI North Kansas City 64116 1141 Swift Avenue P.O. Box 12393 Phone: (816) 221-2070 Fax: (816) 221-2897</p>	<p>PENNSYLVANIA Willow Grove 19090 520 North York Road Phone: (215) 658-1430 Fax: (215) 658-1433</p>	<p>TEXAS Carrollton 75006 (Dallas) 1300 Interstate 35 N, Suite 112 Phone: (972) 446-2996 Fax: (972) 446-8157</p>
<p>San Leandro 94577 (Oakland) 3039 Teagarden Street Phone: (510) 357-9762 Fax: (510) 357-7939</p>	<p>MARYLAND Elkridge 21075 (Baltimore) 7397-102 Washington Blvd. Phone: (410) 799-9394 Fax: (410) 799-9398</p>	<p>NEW YORK Flushing 11365-1595 (N.Y.C.) 175-25 Horace Harding Expwy. Phone: (718) 225-2040 Fax: (718) 423-9619</p>	<p>Houston 77055 West 10 Business Center 1008 Wirt Road, Suite 120 Phone: (713) 682-0334 Fax: (713) 682-4867</p>
<p>FLORIDA Davie 33314 (Miami) 4343 South State Rd. 7 (441) Unit #107 Phone: (954) 321-6635 Fax: (954) 321-6638</p>	<p>MASSACHUSETTS Braintree 02185 (Boston) 719 Granite Street Phone: (781) 848-9810 Fax: (781) 848-6759</p>	<p>NORTH CAROLINA Charlotte 28270 9129 Monroe Road, Suite 115 Phone: (704) 841-1176 Fax: (704) 708-4625</p>	<p>WASHINGTON Auburn 98001 (Seattle) 3320 West Valley HWY, North Building D, Suite 111 Phone: (253) 333-8353 Fax: (253) 333-9613</p>
<p>Tampa 33609 4538 W. Kennedy Boulevard Phone: (813) 877-9585 Fax: (813) 289-7948</p>	<p>MICHIGAN Madison Heights 48071 (Detroit) 30475 Stephenson Highway Phone: (248) 597-5000 Fax: (248) 597-5004</p>	<p>OHIO Columbus 43214 4560 Indianola Avenue Phone: (614) 263-0929 Fax: (614) 263-1238</p>	

Authorized Service Stations are located in many large cities. Telephone **800-487-8665** or **731-541-6042** for assistance locating one. Parts and accessories for Porter-Cable • Delta products should be obtained by contacting any Porter-Cable • Delta Distributor, Authorized Service Center, or Porter-Cable • Delta Factory Service Center. If you do not have access to any of these, call **888-848-5175** and you will be directed to the nearest Porter-Cable • Delta Factory Service Center. Las Estaciones de Servicio Autorizadas están ubicadas en muchas grandes ciudades. Llame al **800-487-8665** ó al **731-541-6042** para obtener asistencia a fin de localizar una. Las piezas y los accesorios para los productos Porter-Cable • Delta deben obtenerse poniéndose en contacto con cualquier distribuidor Porter-Cable • Delta, Centro de Servicio Autorizado o Centro de Servicio de Fábrica Porter-Cable • Delta. Si no tiene acceso a ninguna de estas opciones, llame al **888-848-5175** y le dirijirán al Centro de Servicio de Fábrica Porter-Cable • Delta más cercano. Des centres de service agréés sont situés dans beaucoup de grandes villes. Appelez au **800-487-8665** ou au **731-541-6042** pour obtenir de l'aide pour en repérer un. Pour obtenir des pièces et accessoires pour les produits Porter-Cable • Delta, s'adresser à tout distributeur Porter-Cable • Delta, centre de service agréé ou centre de service d'usine Porter-Cable • Delta. Si vous n'avez accès à aucun de ces centres, appeler le **888-848-5175** et on vous dirigera vers le centre de service d'usine Porter-Cable • Delta le plus proche.

CANADIAN PORTER-CABLE • DELTA SERVICE CENTERS

<p>ALBERTA Bay 6, 2520-23rd St. N.E. Calgary, Alberta T2E 8L2 Phone: (403) 735-6166 Fax: (403) 735-6144</p>	<p>MANITOBA 1699 Dublin Avenue Winnipeg, Manitoba R3H 0H2 Phone: (204) 633-9259 Fax: (204) 632-1976</p>	<p>QUÉBEC 1515 Ave. St-Jean Baptiste, Québec, Québec G2E 5E2 Phone: (418) 877-7112 Fax: (418) 877-7123</p>
<p>BRITISH COLUMBIA 8520 Baxter Place Burnaby, B.C. V5A 4T8 Phone: (604) 420-0102 Fax: (604) 420-3522</p>	<p>ONTARIO 505 Southgate Drive Guelph, Ontario N1H 6M7 Phone: (519) 836-2840 Fax: (519) 767-4131</p>	<p>1447, Begin St-Laurent, (Montréal), Québec H4R 1V8 Phone: (514) 336-8772 Fax: (514) 336-3505</p>

The following are trademarks of PORTER-CABLE • DELTA (Las siguientes son marcas registradas de PORTER-CABLE • DELTA S.A.) (Les marques suivantes sont des marques de fabricant de la PORTER-CABLE • DELTA): BAMMER®, LASERLOC®, OMNIJIG®, POCKET CUTTER®, PORTA-BAND®, PORTA-PLANE®, PORTER-CABLE®, QUICKSAND®, SANDTRAP®, SAW BOSS®, SPEED-BLOC®, SPEEDMATIC®, SPEEDTRONIC®, STAIR-EASE®, THE PROFESSIONAL EDGE®, THE PROFESSIONAL SELECT®, TIGER CUB®, TIGER SAW®, TORQ-BUSTER®, VERSA-PLANE®, WHISPER SERIES®, DURATRONIC™, FRAME SAW™, INNOVATION THAT WORKS™, JETSTREAM™, MICRO-SET™, MORTEN™, NETWORK™, RIPTIDE™, TRU-MATCH™, WOODWORKER'S CHOICE™, THE AMERICAN WOOD SHOP™ (design), AUTO-SET™, B.O.S.S.™, BUILDER'S SAW™, CONTRACTOR'S SAW™, DELTA™, DELTACRAFT™, HOMECRAFT™, JET-LOCK™, KICKSTAND™, THE LUMBER COMPANY™ (design), MICRO-SET™, Q3™, QUICKSET II™, QUICKSET PLUS™, SAFEGUARD II™, SANDING CENTER™, SIDEKICK™, UNIFENCE™, UNIGUARD™, UNIRIP™, UNISAW™, VERSA-FEEDER™, TPS™, Emc2™.

Trademarks noted with ™ and ® are registered in the United States Patent and Trademark Office and may also be registered in other countries. Las Marcas Registradas con el signo de ™ y ® son registradas por la Oficina de Registros y Patentes de los Estados Unidos y también pueden estar registradas en otros países. Marques déposées, indiquées par la lettre ™ et ®, sont déposées au Bureau des brevets d'invention et marques déposées aux Etats-Unis et pourraient être déposées aux autres pays.