

Instruction manual

Generators

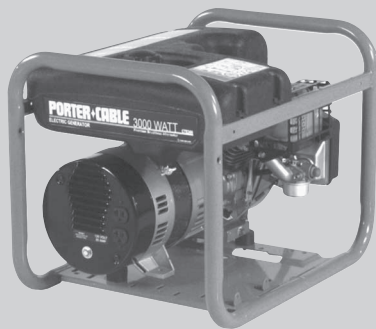

CTE300



T525



BS600

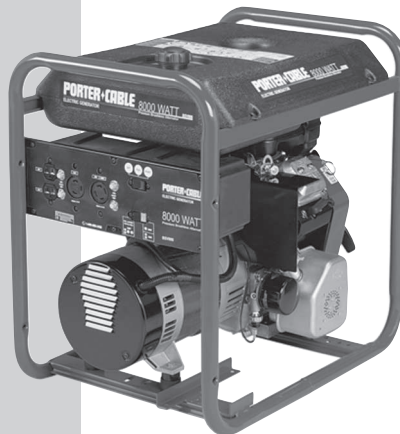

BSV800

To learn more about Porter-Cable
visit our website at:

<http://www.porter-cable.com>

PORTER-CABLE®
PROFESSIONAL POWER TOOLS

IMPORTANT

*Please make certain that the person who is to use this
equipment carefully reads and understands these instructions
before starting operations.*

The Model and Serial No. plate is located on the frame. Record these
numbers in the spaces below and retain for future reference.

Model No. _____

Type _____

Serial No. _____

SPECIFICATION

MODEL	CTE300	T525	BS600	BSV800
HORSE POWER	6.0	10	11	14
RATED/SURGE WATTS	3000/3750	5250/6500	6000/7250	8000/10000
VOLTAGE	120	120/240	120/240	120/240
AMPERAGE	25.0A	43.8/21.9A	50A/25A	66.6A/33.3A
PHASE	SINGLE	SINGLE	SINGLE	SINGLE
HERTZ	60 Hz	60 Hz	60 Hz	60 Hz
ENGINE SPEED	3600 RPM	3600 RPM	3600 RPM	3600 RPM
MAX. AMBIENT TEMP.	104° F	104° F	104° F	104° F
FUEL CAPACITY	4 GALLON	7 GALLON	7 GALLON	7 GALLON
RUN TIME @ 50%/100%	11.5/7.2HRS	10.4/7.0HRS	9.1/6.3 HRS	9.6/5.9 HRS

WARNING

Read Owner's Manual. Do not operate equipment until you have read Owners Manual for Safety, Operation, and Maintenance Instructions.

- **This product is not equipped with a spark arresting muffler.** If the product will be used around flammable materials, or on land covered with materials such as agricultural crops, forest, brush, grass, or other similar items, then an approved spark arrester must be installed and is legally required in the state of California. It is a violation of California statutes section 130050 and/or sections 4442 and 4443 of the California Public Resources Code, unless the engine is equipped with a spark arrester, as defined in section 4442, and maintained in effective working order. Spark arresters are also required on some U. S. Forest service land and may also be legally required under other statutes and ordinances.
- This product may contain chemicals known to the state of California to cause cancer, birth defects, or other reproductive harm. This warning is given in compliance with California Proposition 65, as detectable amounts of chemicals subject to proposition 65 may be contained in this product.

WARRANTY

PORTER-CABLE CORPORATION warrants to the original purchaser that each new electric generator and service part is free from defects in material and workmanship, and agrees to repair or replace under this warranty any defective product or part as follows from the original date of purchase.

2 YEARS – Limited warranty on electric generator alternators and 1 year limited warranty on all other parts.

90 Days – Service parts

Engine warranties are the responsibility of the engine manufacturer. Warranties of merchandise sold by Porter-Cable which has been manufactured by and identified as the product of another company are the responsibility of the manufacturer of that product.

THIS WARRANTY IS NOT TRANSFERABLE AND DOES NOT COVER

- Products sold damaged or incomplete, sold “as is,” sold reconditioned, or used as rental equipment.
- Delivery, installation, or normal adjustments explained in the owner’s manual.
- Damage or liability caused by shipping, improper handling, improper installation, improper maintenance, improper modification, or the use of accessories and/or attachments not specifically recommended by PORTER-CABLE for the product.
- Repairs necessary because of operator abuse or negligence, or the failure to install, operate, maintain, and store the product according to the instructions in the owner’s manual.
- Damage caused by cold, heat, rain, excessive humidity, corrosive environments and materials, or other contaminants.
- Expendable items that become worn during normal use such as fuel filters, air cleaners, spark plugs, and engine oil.
- Cosmetic defects that do not interfere with product functionality.
- Freight costs from customer to Porter-Cable.
- Repair and transportation costs of products or parts determined not to be defective.
- **ANY INCIDENTAL, INDIRECT OR CONSEQUENTIAL LOSS, DAMAGE, OR EXPENSE THAT MAY RESULT FROM ANY DEFECT, FAILURE OR MALFUNCTION OF THE PRODUCT.** Some states do not allow the exclusion or limitation of incidental or consequential damages, so the above limitation or exclusion may not apply to you.
- **IMPLIED WARRANTIES, INCLUDING THOSE OF MERCHANTABILITY AND FITNESS FOR A PARTICULAR PURPOSE, ARE LIMITED TO ONE YEAR FROM THE DATE OF ORIGINAL PURCHASE.** Some states do not allow limitations on how long an implied warranty lasts, so the above limitations may not apply to you.

WARRANTY SERVICE is available by delivering or shipping the defective product or part to any Porter-Cable authorized warranty service location. To determine the nearest authorized warranty service location, call the toll free number, 1-888-559-8550, 24 hours a day, 7 days a week. Specific instructions regarding servicing arrangements and scheduling may vary depending on the type and size of the product and the availability of repair parts.

- DO NOT return the defective product to the retailer.
- Retain the original cash register sales receipt as proof of purchase for warranty work.
- Purchasers should contact Porter-Cable directly if they do not receive satisfactory results from the authorized warranty service center.

PORTER-CABLE®

Porter-Cable Corporation
4825 Highway 45 North
P.O. Box 2468
Jackson, TN 38302-2468
1-888-559-8550

SAFETY GUIDELINES - DEFINITIONS

<p>This manual contains information that is important for you to know and understand. This information relates to protecting YOUR SAFETY and PREVENTING EQUIPMENT PROBLEMS. To help you recognize this information, we use symbols to the right. Please read the manual and pay attention to these sections.</p>	<div style="border: 1px solid black; display: inline-block; padding: 2px 5px;">⚠ DANGER</div> URGENT SAFETY INFORMATION - A HAZARD THAT WILL CAUSE SERIOUS INJURY OR LOSS OF LIFE.	<div style="border: 1px solid black; display: inline-block; padding: 2px 5px;">⚠ CAUTION</div> Information for preventing damage to equipment.
	<div style="border: 1px solid black; display: inline-block; padding: 2px 5px;">⚠ WARNING</div> IMPORTANT SAFETY INFORMATION - A HAZARD THAT <i>MIGHT</i> CAUSE SERIOUS INJURY OR LOSS OF LIFE.	<div style="border: 1px solid black; display: inline-block; padding: 2px 5px;">NOTE</div> Information that you should pay special attention to.

IMPORTANT SAFETY INSTRUCTIONS

- SAVE THESE INSTRUCTIONS •

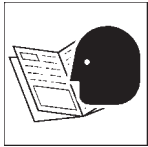

⚠ WARNING

When using this product basic precautions should always be followed including the following:



⚠ DANGER

RISK OF ELECTROCUTION AND FIRE

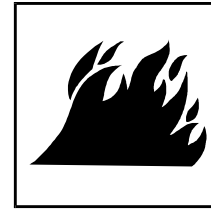

HAZARD	WHAT COULD HAPPEN	HOW TO PREVENT IT
<p>Attempting to connect generator directly to the electrical system of any building structure.</p>	<p>Back feeding electricity through a building's electrical system to the outside utility feed lines could endanger repair persons attempting to restore service.</p> <p>Attempting to connect to the incoming utility service could result in electrocution.</p> <p>Restoration of electrical service while the generator is connected to the incoming utility could result in a fire or serious damage if an isolator switch is not installed.</p> <p>Failure to use a double throw transfer switch when connecting to a structure's electrical system can damage appliances and WILL VOID the manufacturer's warranty.</p>	<p>Never backfeed electricity through a structure's electrical system.</p> <p>To connect to a structure's electrical system in a safe manner, always have a Double-Throw Transfer Switch installed by a qualified electrician and in compliance with local ordinances. (When installing a Double-Throw Transfer Switch, a minimum of 10 gauge wiring must be used.)</p>

**READ AND UNDERSTAND ALL WARNINGS BEFORE
ATTEMPTING TO OPERATE GENERATOR.**

⚠ DANGER

RISK OF ELECTROCUTION AND FIRE (cont'd)

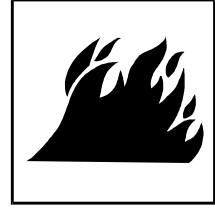

HAZARD	WHAT COULD HAPPEN	HOW TO PREVENT IT
<p>Operation of generator in rain, wet, icy, or flooded conditions.</p>	<p>Water is an excellent conductor of electricity! Water which comes in contact with electrically charged components can transmit electricity to the frame and other surfaces, resulting in electrical shock to anyone contacting them.</p>	<p>Operate generator in a clean, dry, well ventilated area. Make sure hands are dry before touching unit.</p>
<p>Use of worn, damaged, undersized or ungrounded extension cords.</p>	<p>Contact with worn or damaged extension cords could result in electrocution.</p> <p>Use of undersize extension cords could result in overheating of the wires or attached items, resulting in fire.</p> <p>Use of ungrounded cordsets could prevent operation of circuit breakers and result in electrical shock.</p>	<p>Inspect extension cords before use and replace with new cord if required.</p> <p>Use proper size (wire gauge) cordset for application see chart in the Assembly section of this manual.</p> <p>Always use a cordset having a grounding wire with an appropriate grounding plug. DO NOT use an ungrounded plug.</p>
<p>Placing generator on or against highly conductive surface, such as a steel walkway or metal roof.</p>	<p>Accidental leakage of electrical current could charge conductive surfaces in contact with the generator.</p>	<p>Place generator on low conductivity surface such as a concrete slab.</p> <p>ALWAYS operate generator a minimum of six feet from any conductive surface.</p>
<p>Improper connection of items to generator.</p>	<p>Exceeding the load capacity of the generator by attaching too many items, or items with very high load ratings to it could result in overheating of some items or their attachment wiring resulting in fire or electrical shock.</p>	<p>Read the load rating chart and instructions in the Wattage Calculation section. Make sure that the summation of electrical loads for all attachments does not exceed the load rating of the generator.</p>
<p>Operation of unit when damaged, or with guards or panels removed.</p>	<p>Attempting to use the unit when it has been damaged, or when it is not functioning normally could result in fire or electrocution.</p> <p>Removal of guarding could expose electrically charged components and result in electrocution.</p>	<p>Do not operate generator with mechanical or electrical problem. Have unit repaired by an Authorized Service Center.</p> <p>Do not operate generator with protective guarding removed.</p>

**READ AND UNDERSTAND ALL WARNINGS BEFORE
ATTEMPTING TO OPERATE GENERATOR.**

**⚠ WARNING
RISK OF FIRE**



HAZARD	WHAT COULD HAPPEN	HOW TO PREVENT IT
Attempting to fill the fuel tank while the engine is running.	Gasoline and gasoline vapors can become ignited by coming in contact with hot components such as the muffler, engine exhaust gases, or from an electrical spark.	Turn engine off and allow it to cool before adding fuel to the tank. Equip area of operation with a fire extinguisher certified to handle gasoline or fuel fires.
Sparks, fire, hot objects	Cigarettes, sparks, fires, or other hot objects can cause gasoline or gasoline vapors to ignite.	Add fuel to tank in well ventilated area. Make sure there are no sources of ignition near the generator.
Improper storage of fuel	Improperly stored fuel could lead to accidental ignition. Fuel improperly secured could get into the hands of children or other unqualified persons.	Store fuel in a OSHA approved container designed to hold gasoline. Store container in secure location to prevent use by others.
Inadequate ventilation for generator	Materials placed against or near the generator or operating the generator in areas where the temperature exceeds 104° F. ambient (such as storage rooms or garages) can interfere with its proper ventilation features causing overheating and possible ignition of the materials or buildings.	Operate generator in a clean, dry, well ventilated area a minimum of four feet from any building, object or wall. DO NOT OPERATE UNIT INDOORS OR IN ANY CONFINED AREA.
Tampering with factory set engine speed settings.	Engine speed has been factory set to provide safe operation. Tampering with the engine speed adjustment could result in overheating of attachments and could cause a fire.	Never attempt to “ speed-up ” the engine to obtain more performance. Both the output voltage and frequency will be thrown out of standard by this practice, endangering attachments and the user.
Overfilling the fuel tank – fuel spillage.	Spilled fuel and its vapors can become ignited from hot surfaces or sparks.	Use care in filling the tank to avoid spilling fuel. Make sure fuel cap is secured tightly and check engine for fuel leaks before starting engine. Move generator away from refueling area or any spillage before starting engine. Allow for fuel expansion. Keep maximum fuel level ¼ inch below the tip of the fuel tank. Never refuel with the engine running.

**READ AND UNDERSTAND ALL WARNINGS BEFORE
ATTEMPTING TO OPERATE GENERATOR.**



⚠ DANGER

**Risk of Injury and Property Damage When
Transporting Generator**

HAZARD	WHAT COULD HAPPEN	HOW TO PREVENT IT
Fire, Inhalation, Damage to Vehicle Surfaces	Fuel or oil can leak or spill and could result in fire or breathing hazard, serious injury or death can result. Fuel or oil leaks will damage carpet, paint or other surfaces in vehicles or trailers.	If generator is equipped with a fuel shut-off valve, turn the valve to the off position before transporting to avoid fuel leaks. If generator is not equipped with a fuel shut-off valve, drain the fuel from tank before transporting. Transport fuel only in an OSHA approved container. Always place generator on a protective mat when transporting to protect against damage to vehicle from leaks. Remove generator from vehicle immediately upon arrival at your destination



⚠ DANGER

RISK OF BREATHING - INHALATION HAZARD

HAZARD	WHAT COULD HAPPEN	HOW TO PREVENT IT
Gasoline engines produce toxic carbon monoxide exhaust fumes.	Breathing exhaust fumes will cause serious injury or death.	Operate generator in clean, dry, well ventilated area. Never operate unit in enclosed areas such as garages, basements, storage, sheds, or in any location occupied by humans or animals. Keep children, pets and others away from area of operating unit.

**READ AND UNDERSTAND ALL WARNINGS BEFORE
ATTEMPTING TO OPERATE GENERATOR.**



⚠ WARNING
RISK OF UNSAFE OPERATION

HAZARD	WHAT COULD HAPPEN	HOW TO PREVENT IT
Operation of generator in careless manner.	All sources of energy include the potential for injury. Unsafe operation or maintenance of your generator could lead to serious injury or death to you or others.	<ul style="list-style-type: none"> • Review and understand all of the operating instructions and warnings in this manual. • Become familiar with the operation and controls of the generator. Know how to shut it off quickly. • Equip area of operation with a fire extinguisher certified to handle gasoline or fuel fires. • Keep children or others away from the generator at all times.
Operation of voltage sensitive appliances without a voltage surge protector.	Any gasoline operated household generator will incur voltage variations causing damage to voltage sensitive appliances or could result in fire.	<p>Always use a U.L. listed voltage sensitive surge protector to connect voltage sensitive appliances (TV, computer, stereo, etc.). Failure to use a U.L. listed voltage surge protector will void the warranty on your generator.</p> <p>Notice: A multiple outlet strip is not a surge protector. Make sure you use a U.L. listed voltage surge protector.</p>
Operating generator while suspended	Generator will not operate properly and will cause damage to the generator and could cause serious injury or death to you or others.	Never operate generator while suspended or in an unlevel position. Always operate generate on a flat, level surface.

**READ AND UNDERSTAND ALL WARNINGS BEFORE
ATTEMPTING TO OPERATE GENERATOR.**



**⚠ WARNING
RISK OF HOT SURFACES**

HAZARD	WHAT COULD HAPPEN	HOW TO PREVENT IT
Contact with hot engine and generator components.	Contact with hot surfaces, such as engines exhaust components, could result in serious burns.	During operation, touch only the control surfaces of the generator. Keep children away from the generator at all times. They may not be able to recognize the hazards of this product.



**⚠ WARNING
RISK OF MOVING PARTS**

HAZARD	WHAT COULD HAPPEN	HOW TO PREVENT IT
Contact with moving parts can result in serious injury.	The generator contains parts which rotate at high speed during operation. These parts are covered by guarding to prevent injury.	Never operate generator with guarding or cover plates removed. Avoid wearing loose fitting clothing or jewelry which could be caught by moving parts.



**⚠ WARNING
RISK FROM LIFTING**

HAZARD	WHAT COULD HAPPEN	HOW TO PREVENT IT
Lifting a very heavy object.	Serious injury can result from attempting to lift too heavy an object.	The generator is too heavy to be lifted by one person. Obtain assistance from others before you try to move it.

ASSEMBLY

⚠ CAUTION

Read this manual. Do not attempt to operate equipment until you have read this Manual for Safety, Operation, and Maintenance Instructions.

NOTE: This manual is a general manual. Information in this manual may or may not pertain to your model. Please read carefully.

NOTE: Left and right describes the location of a part with the operator facing the outlet panel.

REMOVE GENERATOR FROM CARTON

- Open carton from top.
- Cut carton along dotted lines.
- Remove all carton inserts.
- Remove generator through opening in carton.
- **(CTE300, T525, BSV800)** Remove shipping block from under the generator head by unscrewing the bolt and remove the wood block. It is very important that this is removed before starting your generator. See Figure 1.

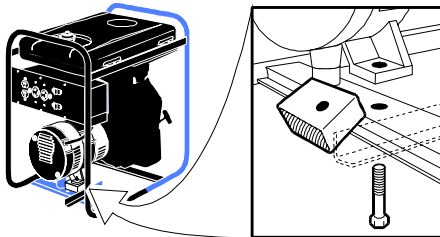

Figure 1

IMPORTANT: Before any attempt to start your generator be sure to check engine oil (See Engine Operator's manual)

GROUNDING THE GENERATOR

A grounding lug is supplied with the generator for use when required by local electrical ordinances. Refer to article 250 of the National Electrical Code to clarify any needed grounding information. Your local electric company or a certified electrician should be able to help you with this information.

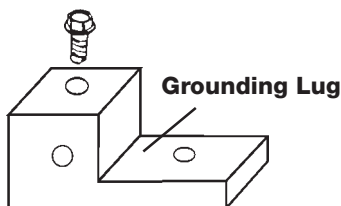

Figure 2

NOTE: Your engine is already grounded to the frame by a grounding strap.

TYPICAL INSTALLATION OF BATTERY (BS600 & BSV800)

- Recommended Battery for Electric Start: 12V - 45 A H. or 210 CCA (Cold Cranking Amps)
 - Purchase battery and battery hardware separately, not included with unit.
1. Place battery in rack with terminals facing towards generator head.
 2. Place battery bracket (A) over battery as shown in Figure 3 (opposite battery terminals).
 3. Place "L" bolt (B) through top and bottom brackets and secure with wing nut (C).

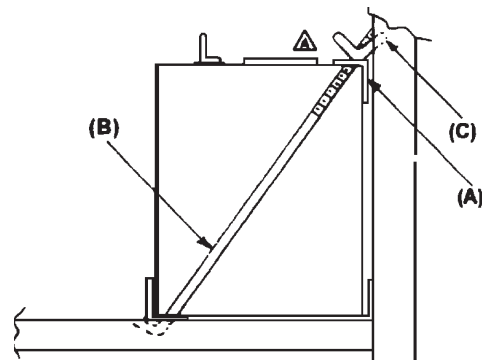

Figure 3

⚠ WARNING

To Prevent sparks connect the red (positive) cable to the positive (+) terminal before connecting the black negative cable.

4. Locate the solenoid on the left side of the unit. See Figures 4 and 5.

For BS600

5. Remove the nut from the solenoid post with the panel assembly wire harness. Place one end of the positive (red) battery cable onto this post with the panel assembly wire. Reassemble nut and tighten securely. See Figure 4.

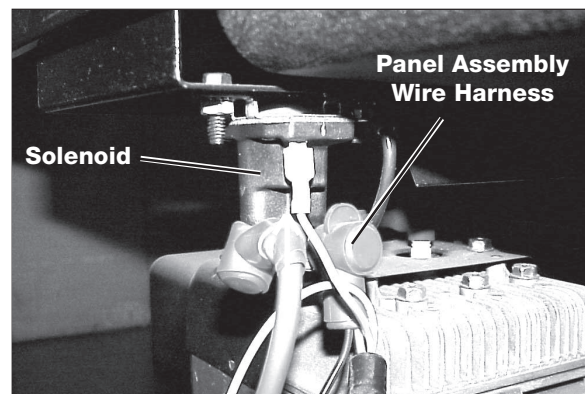

Figure 4

For BSV800

- Remove the nut from the solenoid post and place one end of the positive (red) battery cable onto the post. Reassemble nut and tighten securely. See Figures 5.

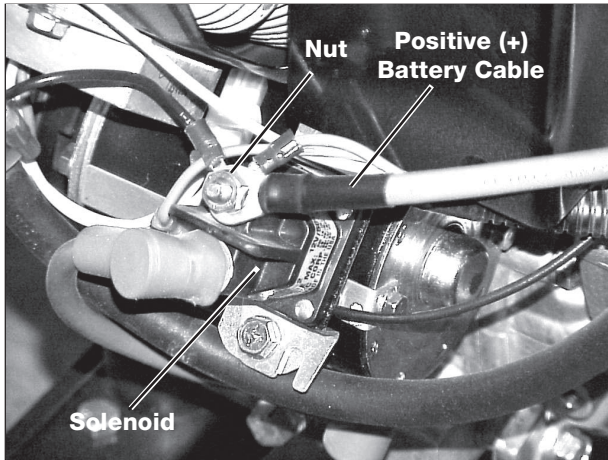

Figure 5

⚠ CAUTION

Battery cables must be routed a safe distance from hot engine parts in order to protect generator from sparks and possible fire resulting in injury or property damage.

- Attach the other end of the positive (red) battery cable to the positive (+) terminal on the battery.
- Attach one end of the negative (black) cable to the negative (-) terminal on the battery.
- Attach the other end of the negative (black) cable to the frame as shown. Install the star washer between the cable and the frame. See Figure 6.

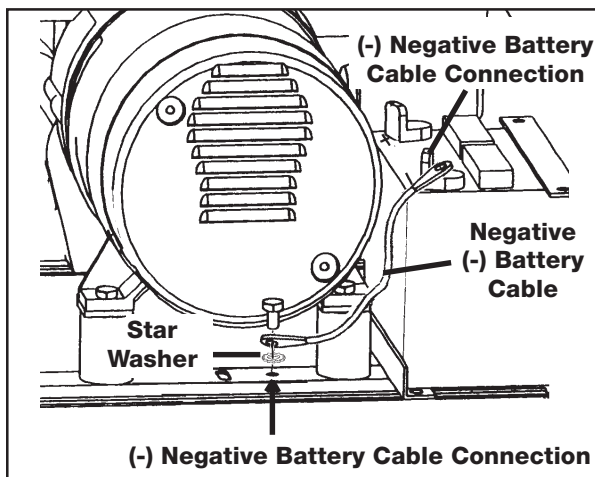

Figure 6

OBTAINING ELECTRICITY FROM THE GENERATOR

There are basically 2 ways to obtain electricity from a generator:

- Use of extension cords directly from the generator to the appliance, lights, tools, etc.
- Use of a double-throw transfer switch installed directly to the main electrical supply outside of house.

Extension Cords

When using an appliance or tool at a considerable distance from the generator, a 3-wire extension cord that has a 3-blade grounding plug and a 3-slot receptacle that accepts the tool's plug **MUST** be used in order to reduce the risk of electrical shock. A cord of adequate size must be used. Using the following chart to determine the minimum wire size required.

Extension Cord Wire Gauge Chart		
Cord Length	Wire Gauge Size	Amperage
0 to 100 ft.	12 ga.	*Up to 20 amp draw
0 to 100 ft.	10 ga.	Up to 30 amp draw

***NOTE:** When amperage exceeds 20 amp; a 12 gauge extension cord should not be used for long distances.

⚠ WARNING

An extension cord that is hot to the touch is overloaded. Repair or replace damaged extension cords immediately.

Double Throw Transfer Switch

⚠ WARNING

Potential hazards exist when a portable electric generator is connected to the main electrical supply coming into the house. It is at that point that the electrical generator could feed back into the utility company's system causing possible electrocution of workers who are repairing the electrical lines.

To avoid back feeding of electricity into utility systems, a double-throw transfer switch must be installed between the generator and utility power. The Double-Throw Transfer Switch should be installed by a licensed electrician and in compliance with all state and local electrical codes. (When installing a Double-Throw Transfer Switch, a minimum of 10 gauge wiring must be used.)

The electrician should also install a sub-panel to isolate the circuits you would want to use during an emergency or electrical power outage. Your generator will not be large enough to handle the load of all the lights, appliances, TV, etc. at one time. To select which items to run during the electrical power outage, see Wattage Calculation section in this manual.

OPERATION

KNOW YOUR GENERATOR

Read this General Manual and Safety Rules before operation of your Generator. Compare the illustration in your parts manual with your generator to familiarize yourself with the location of various controls and adjustments. Save all manuals for future references.

GENERATOR CAPACITY

IMPORTANT: Exceeding the rated capacity of your generator can result in serious damage to your generator and connected electrical devices. See the **Wattage Calculation** section in this manual to assist you in determining the appliances and tools that can be ran with the wattage capacity of your generator.

CIRCUIT BREAKERS

Each receptacle has a circuit breaker to protect the generator from overloading. If the circuit breaker trips, unplug all electrical loads from the generator. Let the circuit breaker cool down. Push circuit breaker button to reset.

LOW OIL SHUTDOWN (CTE300, T525, BS600)

Your generator engine is equipped with Low Oil Shutdown. Low Oil Shutdown is a safety device designed to protect your engine from damage in the event the oil level in the crankcase is low.

If while the engine is running, the oil gets low, it will automatically shut itself down and will not restart until the oil is added. If the oil is low before start-up, the generator will not start until oil is added.

NOTE: The Low Oil Shutdown mechanism is very sensitive. You must fill the engine to the full mark on the dipstick to inactivate this safety device.

FULL POWER SWITCH (BS600 & BSV800)

When placed in the 120V position it allows you to receive the full capacity of the generator by using all 120 volt receptacles. When in the 120/240 position, you will only be able to receive half the available watts when using the 120 volt receptacles and the full available watts when using the 240 4-prong twistlock receptacle.

BEFORE START UP

⚠ CAUTION

This generator has been shipped from the factory without oil in the crankcase. Operating the unit without oil can damage the engine.

⚠ CAUTION

Always check engine oil level before every start. Running engine low of oil or out of oil could result in serious damage to the engine.

Follow the steps listed below before starting generator:

1. Check engine oil. Refer to the Engine Operator's Manual for correct grade and quantity of oil.
2. Check fuel level, fill as required. Make sure generator is turned off and has been allowed time to cool down. Use clean, fresh, regular unleaded gasoline with a minimum of 87 octane. Do not mix oil with gasoline.

⚠ CAUTION

Never fill fuel tank completely. Fill tank to 1/2" below the bottom of the filler neck to provide space for fuel expansion. Wipe any fuel spillage from engine and equipment before starting engine.

⚠ WARNING

Never fill fuel tank indoors. Never fill fuel tank when engine is running or hot. Do not smoke when filling fuel tank.

⚠ CAUTION

Never run engine indoors or in enclosed, poor ventilated areas, engine exhaust contains carbon monoxide, an odorless and deadly gas.

3. Make sure generator is grounded in accordance with local requirements.
4. All electrical loads **MUST** be disconnected

⚠ CAUTION

Engine speed has been factory set to provide safe operation. Tampering with the engine speed adjustment could result in overheating of attachments and could cause a fire. Never attempt to "speed-up" the engine to obtain more performance. Both the output voltage and frequency will be thrown out of standard by this practice, endangering attachments and the user.

⚠ CAUTION

You **MUST** unplug any load from the generator before starting to prevent permanent damage to any appliances.

TO START THE ENGINE (Recoil start/Pull start)

CAUTION

Never run engine indoors or in enclosed, poor ventilated areas, engine exhaust contains carbon monoxide, an odorless and deadly gas.

1. Open the fuel shut-off valve. Turn counter clockwise until the valve stops. See Figure 7.

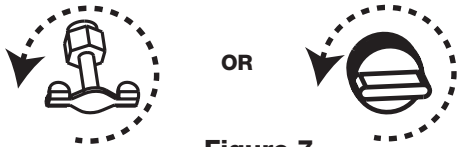

Figure 7

2. **(CTE300 & T525)** On the engine there is a ON/OFF switch located on the front panel of the engine. Place this switch to the "ON" position.
(BS600 & BSV800) Push OFF\RUN\START switch on control panel to the "RUN" position to start engine.
3. Move the choke control located on the engine to "CHOKE" position.

NOTE: No choke is required on warm engines. Make sure choke is in the "RUN" position on warm engine starts.

4. Grasp handle on rope starter and pull slowly until resistance is felt. Let the rope rewind slowly. Pull rope with a rapid full arm stroke. Let rope rewind slowly. Repeat if necessary.

NOTE: IF ENGINE OIL LEVEL IS TOO LOW, ENGINE WILL NOT START. CHECK OIL LEVEL AND ADD IF NECESSARY.

5. When engine starts, gradually move the choke to the "RUN" position.

IMPORTANT: Allow generator to run at no load for 5 minutes upon each initial start-up to allow engine and generator to stabilize.

TO START GENERATOR

(Electric Start BS600 & BSV800)

IMPORTANT: Make sure the battery is properly serviced, fully charged, and assembled before starting.

1. Open the fuel shut-off valve. See Figure 7.
2. Move the choke control located on the engine to "CHOKE" position. A cold engine may require to be choked longer than a warm engine.
3. Push OFF\RUN\START switch on control panel to the "START" position to start engine. Hold in "START" position no longer than 15 seconds per minute when trying to start engine. Extended cranking can damage the starter motor.

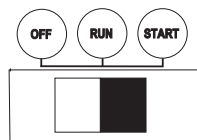

NOTE: When the engine starts the switch will remain in the RUN position.

4. When engine starts, gradually move the choke to the "NO Choke" position.

IMPORTANT: Allow generator to run at no load for 5 minutes upon each initial start-up to allow engine and generator to stabilize.

STOPPING ENGINE

1. Disconnect all electrical loads.
2. **(CTE300 & T525)** Turn ON/OFF switch to "OFF" position.
(BS600 & BSV800) Turn OFF/RUN/START switch to "OFF" position.
3. Close fuel shut-off valve.

CONNECTING ELECTRICAL LOADS

1. Let engine run and warm up for five minutes after starting with no electrical load.

Connect loads in the following manner to prevent damage to equipment:

2. Connect inductive load equipment first, inductive loads consist of refrigerators, freezers, water pumps, air conditioners, or small hand tools. Connect the items that require the most wattage first. See **Wattage Calculation** Section in this manual.
3. Connect the lights next.
4. Voltage sensitive equipment should be the last equipment connected to the generator. Plug voltage sensitive appliances such as TV's, VCR's, microwaves, ovens, computers, and cordless telephones into a UL listed voltage surge protector, then connect the UL listed voltage surge protector to the generator.

CAUTION

Failure to connect and operate equipment in this sequence can cause damage to equipment and will void the warranty on your generator.

Follow the wattage calculation table in the Wattage Calculation section of this manual. Overloading the generator will cause power fluctuations and can damage equipment and appliances.

Porter-Cable Corporation will only be responsible for damage to customer's equipment when the generator is determined to be defective. This determination will only be made by an authorized representative of Porter-Cable Corporation and this decision will be final. Porter-Cable Corporation reserves the right to inspect the electrical connections at the customer's site of operation and test the generator for proper operation before any determination of liability is made. Failure to maintain the equipment or wiring for inspection will void any claim for damages by the customer. Porter-Cable Corporation will not be responsible for equipment damaged as a result of voltage surges, improper operation or improper installation of the generator.

MAINTENANCE

CUSTOMER RESPONSIBILITIES TABLE				
MAINTENANCE TASK	Before each use	Every 25 Hours of Every Season	Every 50 Hours of Every Season	Every 100 Hours of Every Season
Check oil level	X	See Note 2		
Change oil			See Note 1	
Clean Air Filter Assembly		X		
Check Spark Plug				X
Prepare Unit for Storage	Prepare unit for storage if it is to remain idle for more than 30 days.			

Note 1: Change oil after first two (2) operating hours and every 50 operating hours thereafter, more often if operated in extreme dusty or dirty conditions.

Note 2: Check oil after 5 hours of operation

GENERAL RECOMMENDATIONS

The warranty of the generator does not cover items that have been subjected to operator abuse or negligence. To receive full value from the warranty, operator must maintain the generator as instructed in this manual.

ENGINE MAINTENANCE

Refer to the Engine Operator's manual for service and maintenance of the engine.

GENERATOR MAINTENANCE

Your generator should be kept clean and dry at all times. The generator should not be stored or operated in environments that includes excessive moisture, dust or any corrosive vapors. If these substances are on the generator, clean with a cloth or soft bristle brush. Do not use a garden hose or anything with water pressure to clean the generator. Water may enter the cooling air slots and could possibly damage the rotor, stator and the internal windings of the generator head.

Ground Fault Circuit Interrupter (GFCI receptacle) (for BS600)

MONTHLY: For maximum protection against electrical shock the GFCI should be tested monthly.

To test:

1. Depress the TEST button. The RESET button should extend. If the RESET button does not extend, notify a Porter-Cable Authorized Service Center.
2. To restore power, depress the RESET button firmly into the GFCI unit until an audible click is heard. If reset properly, the RESET button is flush with the surface of the test button. When the button stays in, the power is ON.

STORAGE

If you are going to store your generator for more than 30 days, use the following information as a guide to prepare the generator for storage.

⚠ CAUTION

Never store generator with fuel in the tank indoors or in enclosed, poorly ventilated areas, where fumes can reach an open flame, spark or pilot light as on a furnace, water heater, clothes dryer or other gas appliances.

Engine Preparation

1. Add fuel stabilizer to fuel tank to minimize the formation of fuel gum deposits during storage.
2. Run engine at least 5 minutes after adding stabilizer to allow it to enter the fuel system.
3. Next shut off engine.
4. Disconnect the spark plug wire and remove the spark plug.
5. Add one teaspoon of oil through the spark plug hole.
6. Place rag over spark plug hole and pull the recoil a few times to lubricate the combustion chamber.
7. Replace the spark plug, but do not connect the spark plug wire.

NOTE: If a fuel stabilizer is not used, all gasoline must be drained from the tank and carburetor to prevent gum deposits from forming on these parts and causing possible malfunction of the engine.

Generator

- Clean the generator as outlined in the **Maintenance** Section on this manual.
- Check that cooling air slots and openings on generator are open and unobstructed.

Battery (BS600&BSV800)

- Store battery as described by the battery manufacturer.

NOTE: After storing battery for a long period of time it may lose its charge. If the battery loses its charge, manually start the engine with the battery connected. The engine will recharge the battery as it runs.

WATTAGE CALCULATIONS

IMPORTANT

Never exceed the rated capacity of your generator. Serious damage to the generator or appliance could result from an overload.

1. Starting and running wattage requirements should always be calculated when matching a generator's wattage capacity to the appliance or tool.
2. There are two types of electrical appliances that can be powered by your generator:
 - A. Items such as radios, light bulbs, television sets, and microwaves have a "resistive load". Starting wattage and running wattage are the same.
 - B. Items such as refrigerators, air compressors, washer, dryer, and hand tools that use an electrical motor have an "inductive load". Inductive load appliances and tools require approximately 2 to 4 times the listed wattage for **starting** the equipment. This initial load only lasts for a few seconds on start-up but is very important when figuring your total wattage to be used.
 - C. Always start your largest electric motor first, and then plug in other items, one at a time.

NOTE: On 120-volt loads the maximum starting wattage should **NOT** exceed one half of the rated generator wattage. Example: a 5000 rated wattage generator = 2500 maximum starting wattage.

DETERMINING WATTAGE REQUIREMENTS

Before operating this generator list all of the appliances and/or tools that are going to operate at the same time. (Then determine the starting wattage requirements and the running wattage requirements by following example and/or refer to wattage calculator on page 16.)

1. First total the running wattage of all appliances and/or tools that will be operated at the same time.

		<u>Running Watts</u>	<u>Starting Watts</u>
Example 1:			
Lights	=	100 Watts	0
Television	=	300 Watts	0
Slow Cooker	=	<u>250 Watts</u>	<u>0</u>
TOTAL	=	650 Watts	0

2. Next the starting wattages of any appliances and/or tools that will start and stop during operation.

		<u>Running Watts</u>	<u>Starting Watts</u>
Example 2:			
Small Refrigerator		<u>500 Watts</u>	<u>2000 Watts</u>
TOTAL	=	500 Watts	2000 Watts

3. The running wattage of examples 1 & 2 totals 1150 watts. The starting wattage of the small refrigerator is 2000 watts which is 1500 watts more than the running watts. Take this difference of 1500 starting watts from the refrigerator and add to the total running watts of 1150.

Example 3:		1500 Starting Watts	
		<u>1150 Running Watts</u>	
TOTAL	=	2650 Total Watts	

Generator must have a maximum capacity of at least 2650 watts.

WATTAGE CALCULATIONS

STARTING WATTAGE REQUIREMENTS

- Some appliances and tools will list on the motor name plate the starting and running voltage and amperage requirements. Use the following formula to convert voltage and amperage to wattage:

Volts X Amp = Watts

120 volts x 10 amps = 1200 watts

- To determine the approximate starting wattage requirement for most appliances and tools with inductive type motors, multiply the wattage that was calculated by 2 to 4 times to assure adequate generator capacity. If the nameplate information is not available use the values on the following chart as a guide.
- Remember that the starting and running wattage for resistive loads are the same. (**Example:** a 100 watt light bulb requires only 100 watts to start.) Most resistive loads will be listed in wattage.

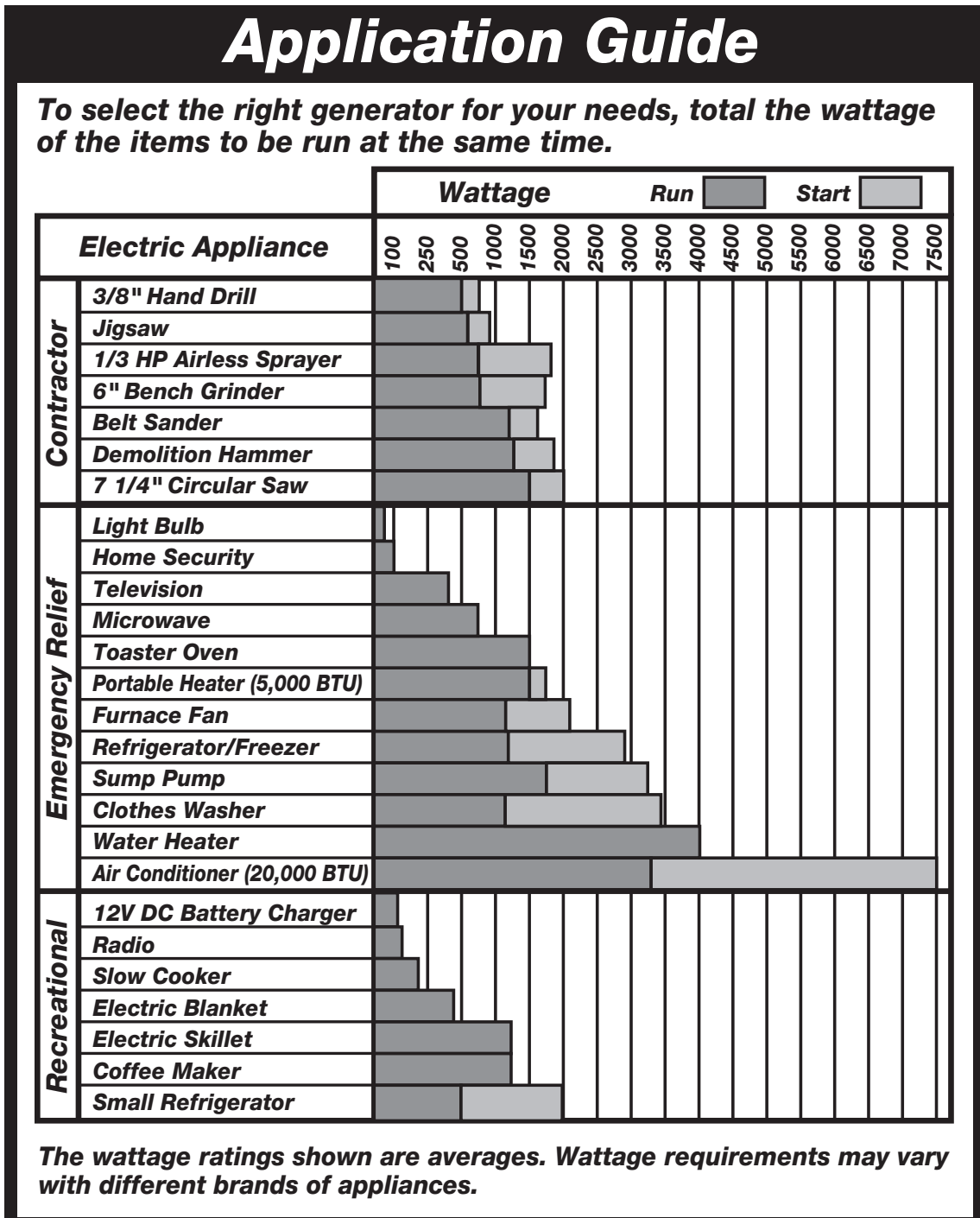

WATTAGE CALCULATIONS

HOUSEHOLD WATTAGE CALCULATOR

DEVICES WITH HIGH STARTING (INDUCTIVE)LOADS			APPLIANCE OR LOAD DEVICE*	TYPICAL DEVICE WATTAGE**	TOTAL
RUN WATTS	TIMES (X) START FACTOR				
800	x 3	→	REFRIGERATOR/ FREEZER	= 2400	= <input style="width: 50px; height: 20px;" type="text"/>
600	x 3	→	SMALL REFRIGERATOR	= 1800	= <input style="width: 50px; height: 20px;" type="text"/>
2400	x 3	→	AIR COND.(ROOM)	= 7200	= <input style="width: 50px; height: 20px;" type="text"/>
1000	x 2	→	SUMP PUMP 1/2 HP	= 2000	= <input style="width: 50px; height: 20px;" type="text"/>
800	x 3	→	FURNACE FAN 1/3 HP	= 2400	= <input style="width: 50px; height: 20px;" type="text"/>
1000	x 2	→	WELL PUMP 1/2 HP	= 2000	= <input style="width: 50px; height: 20px;" type="text"/>

CAUTION !!

DO NOT CONNECT VOLTAGE SENSITIVE ELECTRONIC EQUIPMENT (TV SET, COMPUTER, ETC.) DIRECTLY TO YOUR GENERATOR. IF YOU USE THE GENERATOR TO POWER SENSITIVE EQUIPMENT YOU MUST USE A U.L. LISTED VOLTAGE SURGE PROTECTOR.

NOTICE: FAILURE TO USE A U.L. LISTED VOLTAGE SURGE PROTECTOR WILL DAMAGE YOUR EQUIPMENT AND VOID YOUR WARRANTY.

HOT PLATE	=	1500	=	<input style="width: 50px; height: 20px;" type="text"/>
TELEVISION	=	300	=	<input style="width: 50px; height: 20px;" type="text"/> CAUTION !!
MICROWAVE	=	800	=	<input style="width: 50px; height: 20px;" type="text"/>
SPACE HEATER	=	1500	=	<input style="width: 50px; height: 20px;" type="text"/>
WATER HEATER	=	4000	=	<input style="width: 50px; height: 20px;" type="text"/>

THE IDLE CONTROL MUST BE IN THE OFF POSITION WHEN OPERATING LARGE MOTOR LOADS (FREEZERS, REFRIGERATORS, ETC.) OR VOLTAGE SENSITIVE ELECTRONIC EQUIPMENT (TV, COMPUTERS, ETC.)

LIGHTING	WATTS	x	TIMES NUMBER OF BULBS	=	TOTAL
60 WATT BULBS	60	x	<input style="width: 50px; height: 20px;" type="text"/>	=	<input style="width: 50px; height: 20px;" type="text"/>
75 WATT BULBS	75	x	<input style="width: 50px; height: 20px;" type="text"/>	=	<input style="width: 50px; height: 20px;" type="text"/>
100 WATT BULBS	100	x	<input style="width: 50px; height: 20px;" type="text"/>	=	<input style="width: 50px; height: 20px;" type="text"/>
300 WATT BULBS	300	x	<input style="width: 50px; height: 20px;" type="text"/>	=	<input style="width: 50px; height: 20px;" type="text"/>

*FOR PRODUCTS NOT LISTED REFER TO CALCULATION INSTRUCTIONS

**AVERAGE VALUES - ACTUAL INDIVIDUAL DEVICE VOLTAGES MAY BE HIGHER OR LOWER

ELECTRIC LOAD GRAND TOTAL

THIS TOTAL MUST BE LESS THAN YOUR GENERATOR RATING

WATTAGE RATING OF YOUR GENERATOR

THIS TOTAL MUST BE GREATER THAN YOUR HOUSEHOLD WATTAGE LOAD

TROUBLESHOOTING GUIDE

PROBLEM	CAUSE	CORRECTION
Engine will not start	<ol style="list-style-type: none"> 1. Low on fuel or oil. 2. Ignition switch in "Off" position. 3. Faulty spark plug. 4. Choke in wrong position. 5. Fuel shut-off valve in closed position. 6. Unit loaded during start-up. 7. Spark plug wire loose. 	<ol style="list-style-type: none"> 1. Add fuel or oil. 2. Turn to "ON" position 3. Replace spark plug. 4. Adjust choke accordingly. 5. Open fuel shut-off valve. 6. Remove load from unit. 7. Attach wire to spark plug.
No electrical output	<ol style="list-style-type: none"> 1. Faulty receptacle. 2. Circuit breaker kicked out. 3. Defective capacitor. 4. Faulty power cord. 5. GFCI switch breaker kicked out (BS600) 	<ol style="list-style-type: none"> 1. Have Service Center replace. 2. Depress and reset. 3. Have Service Center replace capacitor. 4. Repair or replace cord. 5. Depress and reset
Repeated circuit breaker tripping	<ol style="list-style-type: none"> 1. Overload 2. Faulty cords or equipment. 	<ol style="list-style-type: none"> 1. Reduce load. 2. Check for damaged, bare, or frayed wires on equipment. Replace.
Generator overheating	<ol style="list-style-type: none"> 1. Generator overloaded. 2. Insufficient ventilation. 	<ol style="list-style-type: none"> 1. Reduce load. 2. Move to adequate supply of fresh air.

Generator Quick Facts

CALL 1-888-559-8550 TO FIND A LOCAL AUTHORIZED SERVICE CENTER NEAR YOU FOR REPAIRS AND SERVICE PART PURCHASES

ENGINE GAS	Use clean, fresh gasoline with a minimum 87 octane rating. Do not add gasoline during or immediately after use.
ENGINE OIL	Refer to engine owner's manual for oil recommendations.
	Most generators are equipped with a low-oil shutdown. If the oil is low or if the Generator is not level, the engine will not start.
WATTAGE	Make wattage calculations before use. Refer to general operator's manual for further instructions.
WIRING	Contact an electrician for any wiring instructions. If wiring into a house, a double-throw transfer switch and a heavy duty cord set must be used.
BATTERY VOLT REG.	Use a standard (12V) lawn and garden battery with a minimum of 45 A.H. or 210 CCA.
	The voltage and frequency are regulated by the rpm's of the engine. Do not adjust the throttle or governor to achieve higher performance. This will only alter the factory Pre-set settings and damage anything connected to the generator.
	Be sure a volt/amp surge protector is used when sensitive electronic equipment is used, such as: televisions, computers, stereos, and etc... The damage of such equipment without the use of a protector WILL NOT be covered under warranty.
ENGINE	Do not adjust or attempt maintenance without consulting engine manual or an authorized engine service center.
STORAGE	Add stabilizer to fuel tank and run engine for 5 minutes before storage.
	When in long term storage, operate the generator every 60 days for at least 10 minutes with a load on it. This will prevent the loss of residual magnetism that produces the electricity.
OPERATION	Allow the generator to run 5 minutes at no load for the engine and the genhead to stabilize.
	Make sure the adequate size of extension cord is used. Refer to the Grounding Instructions/Extension Cord section of the owners manual.
	If the generator is operating equipment that is drawing half of the rated watts it is considered 50% load. Using all of the rated watts is considered 100% load.

ALWAYS REFER TO THE MANUALS SUPPLIED WITH THIS UNIT

PORTER-CABLE®

Porter-Cable Corporation
4825 Highway 45 North
P.O. Box 2468
Jackson, TN 38302-2468
1-888-559-8550