

ESPAÑOL: PÁGINA 19
FRANÇAISE: PAGE 37

Instruction manual

MODEL
CPF23400P

Pancake Compressor



To learn more about Porter-Cable
visit our website at:
<http://www.porter-cable.com>

PORTER-CABLE®
PROFESSIONAL POWER TOOLS

Copyright © 2002 PORTER-CABLE Corporation

IMPORTANT

Please make certain that the person who is to use
this equipment carefully reads and understands
these instructions before starting operations.

The Model and Serial No. plate is located on the
frame. Record these numbers in the spaces below
and retain for future reference.

Model No. _____

Type _____

Serial No. _____

Part No. D26120-025-0

SAFETY GUIDELINES - DEFINITIONS

This manual contains information that is important for you to know and understand. This information relates to protecting **YOUR SAFETY** and **PREVENTING EQUIPMENT PROBLEMS**. To help you recognize this information, we use the symbols below. Please read the manual and pay attention to these sections.

<p style="text-align: center;">⚠ DANGER</p> <p>DANGER indicates an imminently hazardous situation which, if not avoided, will result in <u>death or serious injury</u>.</p>	<p style="text-align: center;">⚠ CAUTION</p> <p>CAUTION indicates a potentially hazardous situation which, if not avoided, <u>may</u> result in <u>minor or moderate injury</u>.</p>
<p style="text-align: center;">⚠ WARNING</p> <p>WARNING indicates a potentially hazardous situation which, if not avoided, <u>could</u> result in <u>death or serious injury</u>.</p>	<p style="text-align: center;">CAUTION</p> <p>CAUTION used without the safety alert symbol indicates a potentially hazardous situation which, if not avoided, <u>may</u> result in <u>property damage</u>.</p>
<p>Call our Toll Free Number 1-888-559-8550, to obtain the location of the nearest Authorized Service Center for ordering repair parts and for warranty repairs.</p> <p>When ordering repair parts from your local Authorized Service Center, always give the following information:</p> <ul style="list-style-type: none"> • Model number of your compressor • Part number and description of the item you wish to purchase 	
<p><i>Retain Original Sales Receipt as Proof of Purchase for Warranty Repair Work.</i></p>	

IMPORTANT SAFETY INSTRUCTIONS

⚠ WARNING When using electric tools, basic safety precautions should always be followed to reduce the risk of fire, electric shock and personal injury, including the following:

READ AND FOLLOW ALL INSTRUCTIONS.

This tool was designed for certain applications. Porter-Cable strongly recommends that this tool NOT be modified and/or used for any application other than for which it was designed. If you have any questions relative to its application DO NOT use the tool until you have written Porter-Cable and we have advised you.

Technical Service Manager
 Porter-Cable Corporation
 4825 Highway 45 North
 P.O. Box 2468
 Jackson, TN 38302-2468

IMPORTANT SAFETY INSTRUCTIONS (cont'd)

SAVE THESE INSTRUCTIONS



⚠ WARNING



IMPROPER OPERATION OR MAINTENANCE OF THIS PRODUCT COULD RESULT IN SERIOUS INJURY AND PROPERTY DAMAGE. READ AND UNDERSTAND ALL WARNINGS AND OPERATING INSTRUCTIONS BEFORE USING THIS EQUIPMENT.

HAZARD

RISK OF EXPLOSION OR FIRE



WHAT CAN HAPPEN	HOW TO PREVENT IT
<p>IT IS NORMAL FOR ELECTRICAL CONTACTS WITHIN THE MOTOR AND PRESSURE SWITCH TO SPARK.</p> <p>IF ELECTRICAL SPARKS FROM COMPRESSOR COME INTO CONTACT WITH FLAMMABLE VAPORS, THEY MAY IGNITE, CAUSING FIRE OR EXPLOSION.</p> <p>RESTRICTING ANY OF THE COMPRESSOR VENTILATION OPENINGS WILL CAUSE SERIOUS OVERHEATING AND COULD CAUSE FIRE.</p> <p>UNATTENDED OPERATION OF THIS PRODUCT COULD RESULT IN PERSONAL INJURY OR PROPERTY DAMAGE.</p>	<p>ALWAYS OPERATE THE COMPRESSOR IN A WELL VENTILATED AREA FREE OF COMBUSTIBLE MATERIALS, GASOLINE OR SOLVENT VAPORS.</p> <p>IF SPRAYING FLAMMABLE MATERIALS, LOCATE COMPRESSOR AT LEAST 20 FEET AWAY FROM SPRAY AREA. AN ADDITIONAL LENGTH OF HOSE MAY BE REQUIRED.</p> <p>STORE FLAMMABLE MATERIALS IN A SECURE LOCATION AWAY FROM COMPRESSOR.</p> <p>NEVER PLACE OBJECTS AGAINST OR ON TOP OF COMPRESSOR. OPERATE COMPRESSOR IN AN OPEN AREA AT LEAST 12 INCHES AWAY FROM ANY WALL OR OBSTRUCTION THAT WOULD RESTRICT THE FLOW OF FRESH AIR TO THE VENTILATION OPENINGS.</p> <p>OPERATE COMPRESSOR IN A CLEAN, DRY, WELL VENTILATED AREA. DO NOT OPERATE UNIT INDOORS OR IN ANY CONFINED AREA.</p> <p>ALWAYS REMAIN IN ATTENDANCE WITH THE PRODUCT WHEN IT IS OPERATING.</p>

RISK OF BURSTING



AIR TANK: THE FOLLOWING CONDITIONS COULD LEAD TO A WEAKENING OF THE TANK, AND RESULT IN A VIOLENT TANK EXPLOSION AND COULD CAUSE PROPERTY DAMAGE OR SERIOUS INJURY.

WHAT CAN HAPPEN	HOW TO PREVENT IT
<ol style="list-style-type: none"> 1. FAILURE TO PROPERLY DRAIN CONDENSED WATER FROM THE TANK, CAUSING RUST AND THINNING OF THE STEEL TANK. 2. MODIFICATIONS OR ATTEMPTED REPAIRS TO THE TANK. 3. UNAUTHORIZED MODIFICATIONS TO THE UNLOADER VALVE, SAFETY VALVE, OR ANY OTHER COMPONENTS WHICH CONTROL TANK PRESSURE. 4. EXCESSIVE VIBRATION CAN WEAKEN THE AIR TANK AND CAUSE RUPTURE OR EXPLOSION. <p>ATTACHMENTS & ACCESSORIES: EXCEEDING THE PRESSURE RATING OF AIR TOOLS, SPRAY GUNS, AIR OPERATED ACCESSORIES, TIRES AND OTHER INFLATABLES CAN CAUSE THEM TO EXPLODE OR FLY APART, AND COULD RESULT IN SERIOUS INJURY.</p>	<p>DRAIN TANK DAILY OR AFTER EACH USE. IF TANK DEVELOPS A LEAK, REPLACE IT IMMEDIATELY WITH A NEW TANK OR REPLACE THE ENTIRE COMPRESSOR.</p> <p>NEVER DRILL INTO, WELD, OR MAKE ANY MODIFICATIONS TO THE TANK OR ITS ATTACHMENTS.</p> <p>THE TANK IS DESIGNED TO WITHSTAND SPECIFIC OPERATING PRESSURES. NEVER MAKE ADJUSTMENTS OR PARTS SUBSTITUTIONS TO ALTER THE FACTORY SET OPERATING PRESSURES.</p> <p>FOR ESSENTIAL CONTROL OF AIR PRESSURE, YOU MUST INSTALL A PRESSURE REGULATOR AND PRESSURE GAUGE TO THE AIR OUTLET OF YOUR COMPRESSOR. FOLLOW THE EQUIPMENT MANUFACTURERS RECOMMENDATION AND NEVER EXCEED THE MAXIMUM ALLOWABLE PRESSURE RATING OF ATTACHMENTS. NEVER USE COMPRESSOR TO INFLATE SMALL LOW-PRESSURE OBJECTS SUCH AS CHILDREN'S TOYS, FOOTBALLS, BASKETBALLS. ETC.</p>

IMPORTANT SAFETY INSTRUCTIONS (cont'd)

RISK FROM FLYING OBJECTS



WHAT CAN HAPPEN	HOW TO PREVENT IT
<p>THE COMPRESSED AIR STREAM CAN CAUSE SOFT TISSUE DAMAGE TO EXPOSED SKIN AND CAN PROPEL DIRT, CHIPS, LOOSE PARTICLES AND SMALL OBJECTS AT HIGH SPEED, RESULTING IN PROPERTY DAMAGE OR PERSONAL INJURY.</p>	<p>ALWAYS WEAR ANSI Z87.1 APPROVED SAFETY GLASSES WITH SIDE SHIELDS WHEN USING THE COMPRESSOR.</p> <p>NEVER POINT ANY NOZZLE OR SPRAYER TOWARD ANY PART OF THE BODY OR AT OTHER PEOPLE OR ANIMALS.</p> <p>ALWAYS TURN THE COMPRESSOR OFF AND BLEED PRESSURE FROM THE AIR HOSE AND TANK BEFORE ATTEMPTING MAINTENANCE, ATTACHING TOOLS OR ACCESSORIES.</p>

RISK TO BREATHING



WHAT CAN HAPPEN	HOW TO PREVENT IT
<p>THE COMPRESSED AIR FROM YOUR COMPRESSOR IS NOT SAFE FOR BREATHING! THE AIR STREAM MAY CONTAIN CARBON MONOXIDE, TOXIC VAPORS OR SOLID PARTICLES FROM THE TANK.</p> <p>SPRAYED MATERIALS SUCH AS PAINT, PAINT SOLVENTS, PAINT REMOVER, INSECTICIDES, WEED KILLERS, CONTAIN HARMFUL VAPORS AND POISONS.</p>	<p>ALWAYS OPERATE AIR COMPRESSOR OUTSIDE IN A CLEAN, WELL VENTILATED AREA. AVOID ENCLOSED AREAS SUCH AS GARAGES, BASEMENTS, STORAGE SHEDS, WHICH LACK A STEADY EXCHANGE OF AIR. KEEP CHILDREN, PETS AND OTHERS AWAY FROM AREA OF OPERATION.</p> <p>NEVER INHALE AIR FROM THE COMPRESSOR EITHER DIRECTLY OR FROM A BREATHING DEVICE CONNECTED TO THE COMPRESSOR.</p> <p>WORK IN AN AREA WITH GOOD CROSS-VENTILATION. READ AND FOLLOW THE SAFETY INSTRUCTIONS PROVIDED ON THE LABEL OR SAFETY DATA SHEETS FOR THE MATERIAL YOU ARE SPRAYING. USE A NIOSH/MSHA APPROVED RESPIRATOR DESIGNED FOR USE WITH YOUR SPECIFIC APPLICATION.</p>

RISK OF ELECTRICAL SHOCK



WHAT CAN HAPPEN	HOW TO PREVENT IT
<p>YOUR AIR COMPRESSOR IS POWERED BY ELECTRICITY. LIKE ANY OTHER ELECTRICALLY POWERED DEVICE, IF IT IS NOT USED PROPERLY IT MAY CAUSE ELECTRIC SHOCK.</p> <p>REPAIRS ATTEMPTED BY UNQUALIFIED PERSONNEL CAN RESULT IN SERIOUS INJURY OR DEATH BY ELECTROCUTION.</p> <p>ELECTRICAL GROUNDING: FAILURE TO PROVIDE ADEQUATE GROUNDING TO THIS PRODUCT COULD RESULT IN SERIOUS INJURY OR DEATH FROM ELECTROCUTION. SEE GROUNDING INSTRUCTIONS.</p>	<p>NEVER OPERATE THE COMPRESSOR OUTDOORS WHEN IT IS RAINING OR IN WET CONDITIONS.</p> <p>NEVER OPERATE COMPRESSOR WITH COVER COMPONENTS REMOVED OR DAMAGED.</p> <p>ANY ELECTRICAL WIRING OR REPAIRS REQUIRED ON THIS PRODUCT SHOULD BE PERFORMED BY AUTHORIZED SERVICE CENTER PERSONNEL IN ACCORDANCE WITH NATIONAL AND LOCAL ELECTRICAL CODES.</p> <p>MAKE CERTAIN THAT THE ELECTRICAL CIRCUIT TO WHICH THE COMPRESSOR IS CONNECTED PROVIDES PROPER ELECTRICAL GROUNDING, CORRECT VOLTAGE AND ADEQUATE FUSE PROTECTION.</p>

IMPORTANT SAFETY INSTRUCTIONS (cont'd)

RISK FROM MOVING PARTS



WHAT CAN HAPPEN	HOW TO PREVENT IT
<p>MOVING PARTS SUCH AS THE PULLEY, FLYWHEEL, AND BELT CAN CAUSE SERIOUS INJURY IF THEY COME INTO CONTACT WITH YOU OR YOUR CLOTHING.</p> <p>ATTEMPTING TO OPERATE COMPRESSOR WITH DAMAGED OR MISSING PARTS OR ATTEMPTING TO REPAIR COMPRESSOR WITH PROTECTIVE SHROUDS REMOVED CAN EXPOSE YOU TO MOVING PARTS AND CAN RESULT IN SERIOUS INJURY.</p>	<p>NEVER OPERATE THE COMPRESSOR WITH GUARDS OR COVERS WHICH ARE DAMAGED OR REMOVED.</p> <p>ANY REPAIRS REQUIRED ON THIS PRODUCT SHOULD BE PERFORMED BY AUTHORIZED SERVICE CENTER PERSONNEL.</p>

RISK OF BURNS



WHAT CAN HAPPEN	HOW TO PREVENT IT
<p>TOUCHING EXPOSED METAL SUCH AS THE COMPRESSOR HEAD OR OUTLET TUBES, CAN RESULT IN SERIOUS BURNS.</p>	<p>NEVER TOUCH ANY EXPOSED METAL PARTS ON COMPRESSOR DURING OR IMMEDIATELY AFTER OPERATION. COMPRESSOR WILL REMAIN HOT FOR SEVERAL MINUTES AFTER OPERATION.</p> <p>DO NOT REACH AROUND PROTECTIVE SHROUDS OR ATTEMPT MAINTENANCE UNTIL UNIT HAS BEEN ALLOWED TO COOL.</p>

RISK OF FALLING



WHAT CAN HAPPEN	HOW TO PREVENT IT
<p>A PORTABLE COMPRESSOR CAN FALL FROM A TABLE, WORKBENCH OR ROOF CAUSING DAMAGE TO THE COMPRESSOR AND COULD RESULT IN SERIOUS INJURY OR DEATH TO THE OPERATOR OR BYSTANDERS.</p>	<p>ALWAYS OPERATE COMPRESSOR IN A STABLE SECURE POSITION TO PREVENT ACCIDENTAL MOVEMENT OF THE UNIT. NEVER OPERATE COMPRESSOR ON A ROOF OR OTHER ELEVATED POSITION. USE ADDITIONAL AIR HOSE TO REACH HIGH LOCATIONS.</p>

RISK OF PROPERTY DAMAGE WHEN TRANSPORTING COMPRESSOR (Fire, Inhalation, Damage to Vehicle Surfaces)



WHAT CAN HAPPEN	HOW TO PREVENT IT
<p>OIL CAN LEAK OR SPILL AND COULD RESULT IN FIRE OR BREATHING HAZARD, SERIOUS INJURY OR DEATH CAN RESULT. OIL LEAKS WILL DAMAGE CARPET, PAINT OR OTHER SURFACES IN VEHICLES OR TRAILERS.</p>	<p>ALWAYS PLACE COMPRESSOR ON A PROTECTIVE MAT WHEN TRANSPORTING TO PROTECT AGAINST DAMAGE TO VEHICLE FROM LEAKS. REMOVE COMPRESSOR FROM VEHICLE IMMEDIATELY UPON ARRIVAL AT YOUR DESTINATION.</p>

ESW-99 — 9/26/99

GLOSSARY

CFM: Cubic feet per minute.

SCFM: Standard cubic feet per minute; a unit of measure of air delivery.

PSIG: Pounds per square inch gauge; a unit of measure of pressure.

ASME: American Society of Mechanical Engineers; made, tested, inspected, and registered to meet the standards of ASME.

California Code: Unit may comply with California Code 462 (d) (2)/(M) (2). Specification/model label is on the side of the tank on units that comply with California Code.

Cut-In Pressure: While the motor is off, air tank pressure drops as you continue to use your accessory or air tool. When the tank pressure drops to a certain low level the motor will restart automatically. The low pressure at which the motor automatically restarts is called "cut-in pressure."

Cut-Out Pressure: When you turn on your air compressor and it begins to run, air pressure in the air tank begins to build. It builds to a certain high pressure before the motor automatically shuts off - protecting your air tank from pressure higher than its capacity. The high pressure at which the motor shuts off is called "cut-out pressure."

Code Certification: Products that bear one or more of the following marks: UL, CUL, ETL, CETL, have been evaluated by OSHA certified independent safety laboratories and meet the applicable Underwriters Laboratories Standards for Safety.

DUTY CYCLE

Porter-Cable air compressors should be operated on not more than a 50% duty cycle. This means an air compressor that pumps air more than 50% of one hour is considered misuse, because the air compressor is undersized for the required air demand. Maximum compressor pumping time per hour is 30 minutes.

SPECIFICATIONS

Model No.	CPF23400P
Horsepower Peak	3.0
Bore	2.375"
Stroke	1.35"
* Voltage/Hertz/Phase	120/60/1
** Minimum Branch Circuit Requirement	15 amps
* Fuse Type	Time Delay
Amperage at Max. Load	15 Amp
Air Tank Capacity (Gallon)	4
Approximate Cut-in Pressure	110 PSIG
Approximate Cut-out Pressure	135 PSIG
SCFM @ 40 PSIG	7.7
SCFM @ 90 PSIG	5.3

* **CAUTION** This air compressor can be operated on a 15 amp circuit if

1. Voltage supply to circuit is normal.
2. Circuit is not used to supply any other electrical needs (lights, appliances, etc.)
3. Extension cords comply with specifications in owners manual.
4. Circuit is equipped with 15 amp circuit breaker or 15 amp time delay fuse.

If any of the above conditions cannot be met, or if operation of the air compressor repeatedly causes interruption of the power it may be necessary to operate it from a 20 amp circuit. It is not necessary to change the cord set.

** A circuit breaker is preferred. Use only a fuse or circuit breaker that is the same rating as the branch circuit on which the air compressor is operated. If the air compressor is connected to a circuit protected by fuses, use dual element time delay fuses.

DESCRIPTION OF OPERATION

Drain Valve (not shown): The drain valve is located at the base of the air tank and is used to drain condensation at the end of each use.

Motor Thermal Overload Protector (not shown): The electric motor has an automatic thermal overload protector. If the motor overheats for any reason, the thermal overload protector will shut off the motor. The motor must be allowed to cool before restarting.

ON/AUTO - OFF Switch (A) Fig. 1: Turn this switch ON to provide automatic power to the pressure switch and OFF to remove power at the end of each use.

Air Intake Filter (not shown): This filter is designed to clean air coming into the pump. This filter **must** always be clean and ventilation openings free from obstructions. See "Maintenance".

Air Compressor Pump (not shown): To compress air, the piston moves up and down in the cylinder. On the downstroke, air is drawn in through the air intake valves.

The exhaust valve remains closed. On the upstroke of the piston, air is compressed. The intake valves close and compressed air is forced out through the exhaust valve, into the outlet tube, through the check valve and into the air tank. Working air is not available until the compressor has raised the air tank pressure above that required at the air outlet.

Check Valve (not shown): When the air compressor is operating, the check valve is "open", allowing compressed air to enter the air tank. When the air compressor reaches "cut-out" pressure, the check valve "closes", allowing air pressure to remain inside the air tank.

Pressure Release Valve (not shown): The pressure release valve located on the side of the pressure switch, is designed to automatically release compressed air from the compressor head and the outlet tube when the air compressor reaches "cut-out" pressure or is shut off. The pressure release valve allows the motor to restart freely. When the motor stops running, air will be heard escaping from this valve for a few seconds. No air should be heard leaking when the motor is running, or continuous leaking after unit reaches cut-out pressure.

Pressure Switch (B) Fig. 1: The pressure switch automatically starts the motor when the air tank pressure drops below the factory set "cut-in" pressure. It stops the motor when the air tank pressure reaches the factory set "cut-out" pressure.

Safety Valve (C) Fig. 1: If the pressure switch does not shut off the air compressor at its cut-out pressure setting, the safety valve will protect against high pressure by "popping out" at its factory set pressure (slightly higher than the pressure switch cut-out setting).

Outlet Pressure Gauge (D) Fig. 1: The outlet pressure gauge indicates the air pressure available at the outlet side of the regulator. This pressure is controlled by the regulator and is always less than or equal to the tank pressure.

Tank Pressure Gauge (E) Fig. 1: The tank pressure gauge indicates the reserve air pressure in the tank.

Regulator (F) Fig. 1: Controls the air pressure shown on the outlet pressure gauge. Pull the knob out and turn clockwise to increase pressure and counterclockwise to decrease pressure. When the desired pressure is reached push knob in to lock in place. To avoid minor readjustment after making a change in pressure setting, always approach the desired pressure from a lower pressure. When reducing from a higher to a lower setting, first reduce to some pressure less than that desired, then bring up to the desired pressure. Depending on the air requirements of each particular accessory, the outlet regulated air pressure may have to be adjusted while you are operating the accessory.

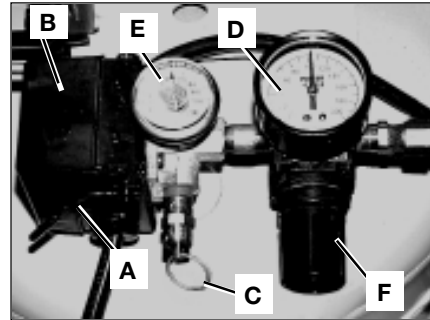

Fig. 1

Location of the Air Compressor

Locate the air compressor in a clean, dry, and well-ventilated area. The air filter must be kept clear of obstructions which could reduce air flow to the air compressor. The air compressor should be located at least 12" away from the wall or other obstructions that will interfere with the flow of air. The air compressor head and shroud are designed to allow for proper cooling. If humidity is high, an air filter can be installed on the air outlet adapter to remove excessive moisture. Follow the instructions packaged with the air filter for proper installation.

Lubrication and Oil

This unit needs no lubrication or oiling.

Extension Cords

To avoid voltage drop, power loss, and overheating to the motor, use extra air hose instead of an extension cord. Low voltage can cause damage to the motor.

If an extension cord *must* be used:

- use only a 3-wire extension cord that has a 3-blade grounding plug and a 3-slot receptacle that will accept the plug on the extension cord.
- make sure the extension cord is in good condition.
- the extension cord should be no longer than 50 feet.
- the minimum wire size is 12 gauge (AWG). (Wire size increases as gauge number decreases. 10 AWG and 8 AWG may also be used. DO NOT USE 14 AWG or 16 AWG.)

Voltage and Circuit Protection

Refer to the specification chart for voltage and circuit protection requirements of your compressor. Use only a fuse or circuit breaker that is the same rating as the branch circuit on which the air compressor is operated. If the compressor is connected to a circuit protected by fuses, use only dual element time delay fuses.

GROUNDING INSTRUCTIONS

⚠ DANGER **RISK OF ELECTRICAL SHOCK!** In the event of a short circuit, grounding reduces the risk of shock by providing an escape wire for the electric current. This air compressor must be properly grounded.

If these grounding instructions are not completely understood, or if in doubt as to whether the compressor is properly grounded, have the installation checked by a qualified electrician. The air compressor is equipped with a cord having a grounding wire with an appropriate grounding plug. The plug must be used with an outlet that has been installed and grounded in accordance with all local codes and ordinances. The outlet must have the same configuration as the plug. See Fig. 3. **DO NOT USE AN ADAPTER.**

Inspect the plug and cord before each use. Do not use if there are signs of damage.

⚠ DANGER **Improper grounding can result in electrical shock!**

Do not modify the plug that has been provided. If it does not fit the available outlet, the correct outlet should be installed by a qualified electrician.

If repairing or replacing cord or plug, the grounding wire must be kept separate from the current-carrying wires. Never connect the grounding wire to a flat blade plug terminal. The grounding wire has insulation with an outer surface that is green - with or without yellow stripes.

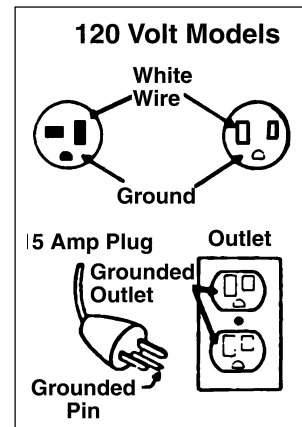

Fig. 3

Additional Regulators and Controls

Since the air tank pressure is usually greater than that which is needed, a separate regulator is usually employed to control the air pressure ahead of any individual air driven device.

BREAK-IN PROCEDURES

⚠ CAUTION Serious damage may result if the following break-in instructions are not closely followed.

This procedure is required before the air compressor is put into service. (before the hose is installed), the check valve is replaced, or a complete compressor pump is replaced.

The procedure:

1. Make sure the pressure switch lever is in the "OFF" position.
2. Plug the power cord into the correct branch circuit receptacle.
3. Open the drain valve fully to permit air to escape and prevent air pressure build up in the air tank during the break-in period.
4. Move the pressure switch lever to "ON/AUTO". The compressor will start.
5. Run the compressor for 15 minutes. Make sure the drain valve is open and there is minimal air pressure build-up in tank.
6. After 15 minutes, close the drain valve.
7. Move the pressure switch lever to "ON/AUTO". The air receiver will fill to cut-out pressure and the motor will stop. The compressor is now ready for use.

OPERATING PROCEDURES

Daily Start-Up Checklist

1. Before attaching air hose or accessories, make sure the ON/AUTO lever is set to "OFF" and the air regulator is closed.
2. Attach hose and accessories.

⚠ WARNING TOO MUCH AIR PRESSURE CAUSES A HAZARDOUS RISK OF BURSTING. CHECK THE MANUFACTURER'S MAXIMUM PRESSURE RATING FOR AIR TOOLS AND ACCESSORIES. THE REGULATOR OUTLET PRESSURE MUST NEVER EXCEED THE MAXIMUM PRESSURE RATING.

3. Turn the ON/AUTO lever to "AUTO" and allow tank pressure to build. Motor will stop when tank pressure reaches "cut-out" pressure.
4. Open the regulator by turning it clockwise. Adjust the regulator to the correct pressure setting. Your compressor is ready for use.
5. Always operate the air compressor in well-ventilated areas free of gasoline or other combustible vapors. If the compressor is being used to operate a sprayer **DO NOT** use near the spray area.

When you are finished:

6. Set the "ON/AUTO" lever to "OFF".
7. Turn the regulator counterclockwise and set the outlet pressure to zero.
8. Remove the air tool or accessory.
9. Pull ring on safety valve allowing air to bleed from the tank until tank pressure is approximately 20 psi. Release safety valve ring.
10. Drain water from air tank by opening drain cock valve on bottom of tank.

⚠ WARNING WATER WILL CONDENSE IN THE AIR TANK. IF NOT DRAINED, WATER WILL CORRODE AND WEAKEN THE AIR TANK CAUSING A RISK OF AIR TANK RUPTURE.

11. After the water has been drained, close the drain cock or drain valve. The air compressor can now be stored.

NOTE

If drain cock valve is plugged, release all air pressure. The valve can then be removed, cleaned, then reinstalled.

MAINTENANCE

⚠ WARNING Unit cycles automatically when power is on. During maintenance, you could be exposed to voltage sources, compressed air, moving parts, or hot surfaces. Personal injuries can occur. Unplug the unit and bleed off all air tank pressure and allow unit to cool before doing any maintenance or repair. Never operate the unit with the belt guard removed.

To ensure efficient operation and longer life of the air compressor unit, a routine maintenance schedule should be prepared and followed. The following routine maintenance schedule is geared to an unit in a normal working environment operating on a daily basis. If necessary, the schedule should be modified to suit the conditions under which your compressor is used. The modifications will depend upon the hours of operation and the working environment. Compressor units in an extremely dirty and/or hostile environment will require a greater frequency of all maintenance checks.

ROUTINE MAINTENANCE SCHEDULE

Daily:

1. Pull ring on safety valve allowing air to bleed from the tank until tank pressure is approximately 20 psi. Release safety valve ring.
2. Drain water from the air tank, any moisture separators, or transformers.
3. Check for any unusual noise and/or vibration.
4. Manually check safety valve to make sure of proper operation.
5. Inspect air filter and replace if necessary.
6. Inspect air lines and fittings for leaks and correct as necessary.

Each Year of Operation or if a Problem is Suspected:

Check condition of air compressor pump intake and exhaust valves. Replace if damaged or worn out.

SERVICE INSTRUCTIONS

Air Filter - Inspection and Replacement

Keep the air filter clean at all times. Do not operate the compressor with the air filter removed. A dirty air filter will not allow the compressor to operate at full capacity. Before you use the compressor, check the air filter to be sure it is clean. If it is dirty replace it.

Safety Valve - Inspection

⚠ WARNING IF THE SAFETY VALVE DOES NOT WORK PROPERLY, OVER-PRESSURIZATION MAY OCCUR, CAUSING AIR TANK RUPTURE OR AN EXPLOSION. DAILY PULL THE RING ON THE SAFETY VALVE TO MAKE SURE THAT THE SAFETY VALVE OPERATES FREELY. IF THE VALVE IS STUCK OR DOES NOT OPERATE SMOOTHLY, IT MUST BE REPLACED WITH THE SAME TYPE OF VALVE.

Check Valve Replacement

1. Release all air pressure from air tank and unplug unit.
2. Loosen the top and bottom nuts and remove the outlet tube.
3. Remove the pressure release tube and fitting.
4. Unscrew the check valve using a socket wrench.

5. Check that the valve disc moves freely inside the check valve and that the spring holds the disc in the upper, closed position. The check valve may be cleaned with a strong solvent.
6. Apply sealant to the check valve threads. Reinstall the check valve.
7. Replace the pressure release tube and fitting.
8. Replace the outlet tube and tighten top and bottom nuts.

Motor

The motor has an automatic reset thermal overload protector. If the motor overheats for any reason, the overload protector will shut off the motor. The motor must be allowed to cool down before restarting. The air compressor will automatically restart after the motor cools.

If the overload protector shuts the motor off frequently, check for a possible voltage problem. Low voltage can also be suspected when:

1. The motor does not get up to full power or speed.
2. Fuses blow out when starting the motor; lights dim and remain dim when motor is started and/or is running.

Motor - Wiring Diagram

The motor connection diagram is located on the side of motor.

STORAGE

Before you store the air compressor, make sure you do the following:

1. Review the "Maintenance" section on the preceding pages and perform scheduled maintenance as necessary.
2. Set the "ON/AUTO" lever to "OFF".
3. Turn the regulator counterclockwise and set the outlet pressure to zero.
4. Remove the air tool or accessory.
5. Pull ring on safety valve allowing air to bleed from the tank until tank pressure is approximately 20 psi. Release safety valve ring.
6. Drain water from air tank by opening drain cock valve on bottom of tank.

▲ WARNING WATER WILL CONDENSE IN THE AIR TANK. IF NOT DRAINED, WATER WILL CORRODE AND WEAKEN THE AIR TANK CAUSING A RISK OF AIR TANK RUPTURE.

7. After the water has been drained, close the drain cock or drain valve.

NOTE

If drain cock valve is plugged, release all air pressure. The valve can then be removed, cleaned, then reinstalled.

8. Protect the electrical cord and air hose from damage (such as being stepped on or run over). Wind them loosely around the compressor handle. (If so equipped)

Store the air compressor in a clean and dry location.

TROUBLESHOOTING GUIDE

⚠WARNING PERFORMING REPAIRS MAY EXPOSE VOLTAGE SOURCES, MOVING PARTS OR COMPRESSED AIR SOURCES. PERSONAL INJURY MAY OCCUR. PRIOR TO ATTEMPTING ANY REPAIRS, UNPLUG THE AIR COMPRESSOR AND BLEED OFF ALL AIR TANK AIR PRESSURE.

PROBLEM	CAUSE	CORRECTION
Excessive tank pressure - safety valve pops off.	Pressure switch does not shut off motor when compressor reaches "cut-out" pressure. Pressure switch "cut-out" too high.	Move the pressure switch lever to the "OFF" position. If the unit doesn't shut off, and the electrical contacts are welded together, replace the pressure switch. Contact an authorized service center to check and replace pressure switch.
Air leaks at fittings.	Tube fittings are not tight enough.	Tighten fittings where air can be heard escaping. Check fittings with soapy water solution. DO NOT OVER-TIGHTEN.
Air leaks at or inside check valve.	Malfunctioning or dirty check valve.	A malfunctioning check valve results in a constant air leak at the pressure release valve when pressure is in the tank and the compressor is shut off. Drain tank then remove and clean or replace check valve. DO NOT OVER-TIGHTEN.
Air leaks at pressure switch release valve.	Malfunctioning pressure switch release valve. Malfunctioning check valve.	Remove and replace the release valve. A malfunctioning check valve results in a constant air leak at the pressure release valve when pressure is in the tank and the compressor is shut off. Drain tank then remove and clean or replace check valve. DO NOT OVER-TIGHTEN.
Air leaks in air tank or at air tank welds.	Damaged air tank.	⚠WARNING DO NOT DRILL INTO, WELD OR OTHERWISE MODIFY AIR TANK OR IT WILL WEAKEN. THE TANK CAN RUPTURE OR EXPLODE. TANK MUST BE REPLACED.
Air leaks between head and valve plate.	Leaking o-ring.	Torque head screws to 8 ft.-lbs. If this does not stop leak, replace o-ring.

PROBLEM	CAUSE	CORRECTION
<p>Pressure reading on the regulated pressure gauge drops when an accessory is used.</p>	<p>It is normal for "some" pressure drop to occur.</p>	<p>If there is an excessive amount of pressure drop when the accessory is used, adjust the regulator following the instructions on page 7.</p> <p>NOTE: Adjust the regulated pressure under flow conditions (while accessory is being used).</p>
<p>Motor will not run or restart.</p>	<p>Motor overload protection switch has tripped.</p> <p>Tank pressure exceeds pressure switch "cut-in" pressure.</p> <p>Wrong gauge wire or length of extension cord.</p> <p>Check valve stuck open.</p> <p>Loose electrical connections.</p> <p>Possible defective motor or starting capacitor.</p> <p>Paint spray on internal motor parts.</p> <p>Fuse blown, circuit breaker tripped.</p> <p>Pressure release valve on pressure switch has not unloaded head pressure.</p>	<p>Let motor cool off and overload switch will automatically reset.</p> <p>Motor will start automatically when tank pressure drops below "cut-in" pressure of pressure switch.</p> <p>Check for proper gauge wire and cord length.</p> <p>Remove and clean, or replace.</p> <p>Check wiring connection inside pressure switch and terminal box area.</p> <p>Contact an Authorized Warranty Service Center for inspection or replacement, if necessary.</p> <p>Have checked by an Authorized Warranty Service Center. Do not operate the compressor in the paint spray area. See flammable vapor warning.</p> <ol style="list-style-type: none"> 1. Check fuse box for blown fuse and replace, if necessary. Reset circuit breaker. Do not use a fuse or circuit breaker with higher rating than that specified for your particular branch circuit. 2. Check for proper fuse; only time delay fuses are acceptable. 3. Check for low voltage conditions and/or proper extension cord. 4. Disconnect the other electrical appliances from circuit or operate the compressor on its own branch circuit. <p>Bleed the line by pushing the lever on the pressure switch to the "off" position; if the valve does not open, replace it.</p>

PROBLEM	CAUSE	CORRECTION
Air leak from safety valve.	Possible defect in safety valve.	Operate safety valve manually by pulling on ring. If valve still leaks, it should be replaced.
Knocking Noise.	Defective check valve.	Remove and clean, or replace.
Compressor is not supplying enough air to operate accessories.	<p>Prolonged excessive use of air. Compressor is not large enough for air requirement.</p> <p>Restricted air intake filter.</p> <p>Hole in hose. Check valve restricted. Air leaks.</p>	<p>Decrease amount of air usage. Check the accessory air requirement. If it is higher than the SCFM or pressure supplied by your air compressor, you need a larger compressor.</p> <p>Clean or replace air intake filter. Do not operate the air compressor with the filter removed. See page 11.</p> <p>Check and replace if required. Remove and clean, or replace. Tighten fittings. (See Air Leaks Section of Troubleshooting Guide.)</p>
Regulator knob has continuous air leak. Regulator will not shut off air outlet.	<p>Pressure release valve on pressure switch has not unloaded head pressure. Damaged regulator.</p>	Replace regulator.

ACCESSORIES

Accessories can be found at the store the unit was purchased or at a local hardware store.

FILTERS, REGULATORS, LUBRICATORS



FILTER / REGULATOR

Regulates air pressure and removes moisture, oil and other debris from the air line. Protects tools from rust and is essential when spray painting. Locate as close to the tool as possible.

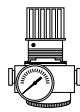

REGULATOR

Controls air pressure downstream and/or in secondary feeder lines.

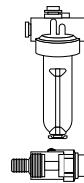

LUBRICATOR OR INLINE OILER

Administers oil into the air line. Reduces excessive wear and rusting in tools. Do not use when spray painting.

PLUMBING COMPONENTS



CONNECTORS

Connects components that have similar NPT threads; Male or Female.



ADAPTERS

Combines components that have different NPT threads; Male or Female.



360° SWIVEL CONNECTOR

Eliminates hose twist and improves tool handling.

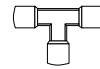

T-FITTING

Ideal for branching air lines.

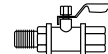

INLINE VALVE

On/Off valve. Controls air flow; not air pressure.

HOSE

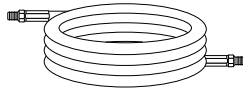

3/8" I.D. HOSE

Ideal for increasing working distance in high CFM applications.

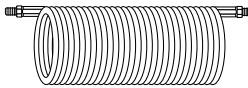

1/4" COIL HOSE

Self-retracting and lightweight. Less bulk than regular hoses. Ideal secondary hose line in lower CFM applications.

QUICK-CONNECTS



BODIES & PLUGS

Together they provide quick and easy attachment/separation of components within the air line. Do not mix different styles of bodies/plugs.

NOTES

LIMITED WARRANTY

PORTER-CABLE CORPORATION warrants to the original purchaser that all products covered under this warranty are free from defects in material and workmanship. Products covered under this warranty include air compressors, air tools, service parts, pressure washers, and generators, which have the following warranty periods:

- 3 YEARS** - Limited warranty on 2-stage oil-free air compressor pumps that operate at 1725 RPM.
- 2 YEARS** - Limited warranty on oil-lubricated air compressor pumps.
- 1 YEAR** - Limited warranty on all other air compressor components.
- 2 YEARS** - Limited warranty on electric generator alternators.
- 1 YEAR** - Limited warranty on other generator components.
- 2 YEARS** - Limited warranty on pneumatic air tools as described in Porter-Cable general catalog.
- 1 YEAR** - Limited warranty on pressure washers used in consumer applications (i.e. personal residential household usage only).
- 90 DAY** - Pressure washers used for commercial applications (income producing) and service parts.
- 1 YEAR** - Limited warranty on all accessories.

Porter-Cable will repair or replace, at **Porter-Cable's** option, products or components which have failed within the warranty period. Service will be scheduled according to the normal work flow and business hours at the service center location, and the availability of replacement parts. All decisions of **Porter-Cable Corporation** with regard to this limited warranty shall be final.

This warranty gives you specific legal rights, and you may also have other rights which vary from state to state.

RESPONSIBILITY OF ORIGINAL PURCHASER (initial User):

- To process a warranty claim on this product, DO NOT return it to the retailer. The product must be evaluated by an **Porter-Cable** Authorized Warranty Service Center. For the location of the nearest **Porter-Cable** Authorized Warranty Service Center call 1-888-559-8550, 24 hours a day, 7 days a week.
- Retain original cash register sales receipt as proof of purchase for warranty work.
- Use reasonable care in the operation and maintenance of the product as described in the Owners Manual(s).
- Deliver or ship the product to the nearest **Porter-Cable** Authorized Warranty Service Center. Freight costs, if any, must be paid by the purchaser.
- Air compressors with 60 and 80 gallon tanks will be inspected at the site of installation. Contact the nearest **Porter-Cable** Authorized Warranty Service Center that provides on-site service calls, for service call arrangements.
- If the purchaser does not receive satisfactory results from the **Porter-Cable** Authorized Warranty Service Center, the purchaser should contact Porter-Cable.

THIS WARRANTY DOES NOT COVER:

- Merchandise sold as reconditioned, used as rental equipment, and floor or display models.
- Merchandise that has become damaged or inoperative because of ordinary wear, misuse*, cold, heat, rain, excessive humidity, freeze damage, use of improper chemicals, negligence, accident, failure to operate the product in accordance with the instructions provided in the Owners Manual(s) supplied with the product, improper maintenance, the use of accessories or attachments not recommended by **Porter-Cable**, or unauthorized repair or alterations.
 - * An air compressor that pumps air more than 50% during a one hour period is considered misuse because the air compressor is undersized for the required air demand.
- Repair and transportation costs of merchandise determined not to be defective.
- Costs associated with assembly, required oil, adjustments or other installation and start-up costs.
- Expendable parts or accessories supplied with the product which are expected to become inoperative or unuseable after a reasonable period of use, including but not limited to sanding disks or pads, saw and shear blades, grinding stones, springs, chisels, nozzles, o-rings, air jets, washers and similar accessories.
- Merchandise sold by **Porter-Cable** which has been manufactured by and identified as the product of another company, such as gasoline engines. The product manufacturer's warranty, if any, will apply.
- **ANY INCIDENTAL, INDIRECT OR CONSEQUENTIAL LOSS, DAMAGE, OR EXPENSE THAT MAY RESULT FROM ANY DEFECT, FAILURE OR MALFUNCTION OF THE PRODUCT IS NOT COVERED BY THIS WARRANTY.** Some states do not allow the exclusion or limitation of incidental or consequential damages, so the above limitation or exclusion may not apply to you.
- **IMPLIED WARRANTIES, INCLUDING THOSE OF MERCHANTABILITY OR FITNESS FOR A PARTICULAR PURPOSE, ARE LIMITED TO ONE YEAR FROM THE DATE OF ORIGINAL PURCHASE.** Some states do not allow limitations on how long an implied warranty lasts, so the above limitations may not apply to you.

PORTER-CABLE

Porter-Cable Corporation
Jackson, TN USA
1-888-559-8550