

# SUPPLEMENTARY INSTRUCTION MANUAL

## DOVETAIL JIG

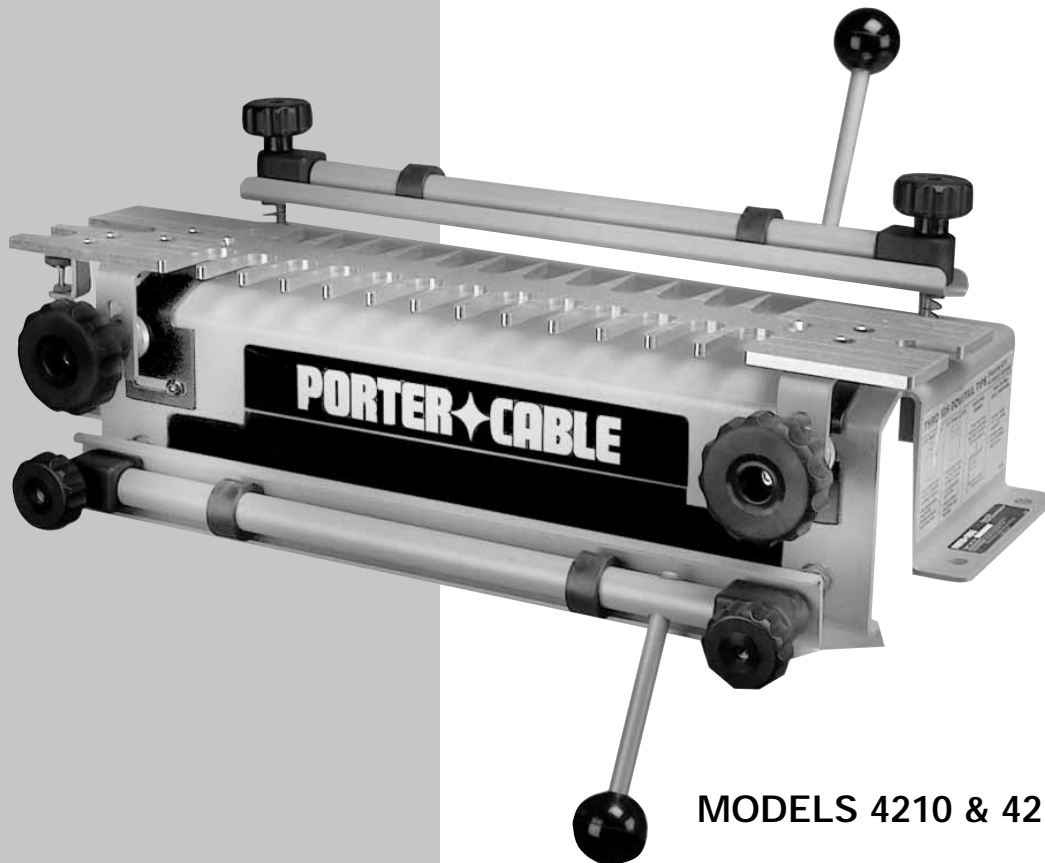

MODELS 4210 & 4212

### IMPORTANT

*Please make certain that the person who is to use this equipment carefully reads and understands these instructions before starting operations.*

The Model and Serial No. plate is located on the main housing of the tool. Record these numbers in the spaces below and retain for future reference.

Model No. \_\_\_\_\_

Type \_\_\_\_\_

Serial No. \_\_\_\_\_

To learn more about Porter-Cable  
visit our website at:

<http://www.porter-cable.com>

**PORTER-CABLE®**

Copyright © 2005, 2007 Porter-Cable

# TABLE OF CONTENTS

SAFETY GUIDELINES .....	3
IMPORTANT SAFETY INSTRUCTIONS .....	3
ADDITIONAL SPECIFIC SAFETY RULES .....	4
BACKGROUND INFORMATION .....	4
OPERATION .....	5
MISCELLANEOUS TECHNIQUES .....	5
THROUGH-DOVETAILS WITH CLAMPING BOARDS .....	6
THROUGH-DOVETAILS WITH UNLIMITED BOARD WIDTH .....	8
ALTERNATIVE METHOD - THROUGH-DOVETAILS WITH UNLIMITED BOARD WIDTH .....	10
HALF-BLIND DOVETAILS WITH CLAMPING BOARDS .....	11
USING A ROUTER TABLE .....	13
ALTERNATE ROUTER BITS .....	14
HALF-BLIND DOVETAIL TAILBOARDS THICKER THAN 7/8" .....	17
MITERED THROUGH-DOVETAILS .....	18
THROUGH-DOVETAIL, SKIPPED PIN METHOD .....	19
HALF-BLIND DOVETAIL, SKIPPED PIN METHOD .....	20
SAW KERF ALLOWANCE METHOD .....	22
MULTIPLE SPACER METHOD .....	24
END-TO-END JOINTS .....	24
DRAWERS WITH DOVETAIL DADOS .....	25
WOODEN HINGES .....	26
ANGLED JOINTS .....	29
ACUTE ANGLED JOINTS .....	32
SLANTED SIDE JOINTS .....	33
COMPOUND ANGLED JOINTS .....	34
INLAYED THROUGH-DOVETAILS .....	37
INLAYED HALF-BLIND DOVETAIL JOINTS .....	38
INLAYED BOX JOINTS .....	40
TABLES OF COMMONLY AVAILABLE ROUTER BIT SIZES .....	41
TROUBLESHOOTING .....	42
MAINTENANCE .....	42
SERVICE .....	42
ACCESSORIES .....	42
WARRANTY .....	43
SERVICE CENTER LOCATIONS .....	Back Cover

# SAFETY GUIDELINES - DEFINITIONS

This manual contains information that is important for you to know and understand. This information relates to protecting YOUR SAFETY and PREVENTING EQUIPMENT PROBLEMS. To help you recognize this information, we use the symbols to the left. Please read the manual and pay attention to these sections.

- ▲ DANGER** Indicates an imminently hazardous situation which, if not avoided, will result in death or serious injury.
- ▲ WARNING** Indicates a potentially hazardous situation which, if not avoided, could result in death or serious injury.
- ▲ CAUTION** Indicates a potentially hazardous situation which, if not avoided, may result in minor or moderate injury.
- CAUTION** Used without the safety alert symbol indicates potentially hazardous situation which, if not avoided, may result in property damage.

# IMPORTANT SAFETY INSTRUCTIONS



**▲ WARNING** Read and understand all instructions. Failure to follow all instructions listed below, may result in electric shock, fire and/or serious personal injury.

## SAVE THESE INSTRUCTIONS.

**▲ WARNING** There are certain applications for which this tool was designed. Porter-Cable strongly recommends that this tool NOT be modified and/or used for any application other than for which it was designed. If you have any questions relative to its application DO NOT use the tool until you have written Porter-Cable and we have advised you.

Technical Service Manager  
Porter-Cable Corporation  
4825 Highway 45 North  
Jackson, TN 38305

1. **KEEP WORK AREA CLEAN.** Cluttered areas and benches invite injuries.
2. **AVOID DANGEROUS ENVIRONMENT.** Don't expose power tools to rain. Don't use power tools in damp or wet locations. Keep area well lit. Avoid chemical or corrosive environment. Do not use tool in presence of flammable liquids or gases.
3. **GUARD AGAINST ELECTRIC SHOCK.** Prevent body contact with grounded surfaces. For example: pipes, radiators, ranges, refrigerator enclosures.
4. **KEEP CHILDREN AWAY.** Do not let visitors contact tool or extension cord. All visitors should be kept away from work area.
5. **STORE IDLE TOOLS.** When not in use, tools should be stored in dry, and high or locked-up place – out of reach of children.
6. **DON'T FORCE TOOL.** It will do the job better and safer at the rate for which it was intended.
7. **USE RIGHT TOOL.** Don't force small tool or attachment to do the job of a heavy duty tool. Don't use tool for purpose not intended – for example – do not use a circular saw for cutting tree limbs or logs.
8. **DRESS PROPERLY.** Do not wear loose clothing or jewelry. Loose clothing, draw strings and jewelry can be caught in moving parts. Rubber gloves and non-skid footwear are recommended when working outdoors. Wear protective hair covering to contain long hair.
9. **USE ANSI Z87.1 SAFETY GLASSES.** Wear safety glasses or goggles while operating power tools. Also face or dust mask if operation creates dust. All persons in the area where power tools are being operated should also wear safety glasses and face or dust mask.
10. **DON'T ABUSE CORD.** Never carry tool by cord or yank it to disconnect from receptacle. Keep cord from heat, oil, and sharp edges. Have damaged or worn power cord and strain reliever replaced immediately. DO NOT ATTEMPT TO REPAIR POWER CORD.
11. **SECURE WORK.** Use clamps or a vise to hold work. It's safer than using your hand and it frees both hands to operate tool.
12. **DON'T OVERREACH.** Keep proper footing and balance at all times.
13. **MAINTAIN TOOLS WITH CARE.** Keep tools sharp and clean for better and safer performance. Follow instructions for lubricating and changing accessories. Inspect tool cords periodically and if damaged, have repaired by authorized service facility. Inspect extension cords periodically and replace if damaged. Have all worn, broken or lost parts replaced immediately. Keep handles dry, clean and free from oil and grease.
14. **DISCONNECT TOOLS** when not in use, before servicing, and when changing accessories such as blades, bits, cutters, etc.
15. **REMOVE ADJUSTING KEYS AND WRENCHES.** Form habit of checking to see that keys and adjusting wrenches are removed from the tool before turning it on.

16. **AVOID UNINTENTIONAL STARTING.** Do not carry a plugged-in tool with finger on switch. Be sure switch is off when plugging in. Keep hands, body and clothing clear of blades, bits, cutters, etc. when plugging in the tool.
17. **OUTDOOR USE EXTENSION CORDS.** When tool is used outdoors, use only extension cords marked "Suitable for use with outdoor appliances – store indoors when not in use." If an extension cord is to be used outdoors it must be marked with the suffix W-A or w following the cord type designation.
18. **STAY ALERT.** Watch what you are doing. Use common sense. Do not operate tool when you are tired or while under the influence of medication, alcohol or drugs.
19. **CHECK DAMAGED PARTS.** Before further use of the tool, a guard or other part that is damaged should be carefully checked to determine that it will operate properly and perform its intended function. Check for alignment of moving parts, binding of moving parts, breakage of parts, mounting, and any other conditions that may affect its operation. A guard or other part that is damaged should be properly repaired or replaced by an authorized service center unless otherwise indicated elsewhere in this instruction manual. Have defective switches replaced by authorized service center. Do not use tool if switch does not turn it on and off.
20. **WEAR ANSI S3.19 EAR PROTECTION** to safeguard against possible hearing loss.

## ADDITIONAL SAFETY RULES

**⚠ WARNING** FAILURE TO FOLLOW THESE RULES MAY RESULT IN SERIOUS PERSONAL INJURY.

1. **READ AND FOLLOW ALL SAFETY INSTRUCTIONS** in the instruction manual supplied with your router.
2. **SECURE WORK.** Be sure Dovetail Fixture/Jig and work is anchored securely to prevent movement.
3. **BE SURE CORD SET IS FREE** and will not hang up during routing operations.
4. **KEEP HANDS CLEAR** of cutter when motor is running to prevent personal injury.
5. **MAINTAIN FIRM GRIP** on router when starting motor to resist starting torque.
6. **STAY ALERT** and keep cutter free, clear of all foreign objects while motor is running.
7. **BE SURE MOTOR HAS COMPLETELY STOPPED** before removing router from Dovetail Fixture/Jig and setting Dovetail Fixture/Jig down between operations.
8. **NEVER REMOVE ROUTER MOTOR** from router base while template guide and dovetail bit are installed. dovetail bit may not fit through hole in template guide.
9. **TIGHTEN TEMPLATE GUIDE LOCKNUT SECURELY.**
10. **SOME WOOD CONTAINS PRESERVATIVES WHICH CAN BE TOXIC.** Take extra care to prevent inhalation and skin contact when working with these materials. Request, and follow, any safety information available from your material supplier.

### REPLACEMENT PARTS

When servicing use only identical replacement parts.

## BACKGROUND INFORMATION

The details for basic joints are found in the instruction manual for the 4212 Dovetail Jig, along with information regarding the use of various router bits and/or templet guides, and will not be repeated in this supplemental manual. The purpose of this document is to provide you with an advanced knowledge of the jig and to promote that knowledge, along with your creativity, to produce beautiful woodworking projects that can stand the test of time.

# OPERATION

## MISCELLANEOUS TECHNIQUES

Using these techniques can simplify your dovetailing projects.

### USE A DEAD-BLOW HAMMER

Use a plastic dead-blow hammer to join your workpieces together to help prevent the marring of wood (Fig. 1A).

### CHAMFER THE TAIL EDGES

Chamfering the inner tail edges can make the joints go together easier and may prevent damage to the pins (Fig. 1B). Make the chamfers with a file or a chisel. Since the chamfers are located on the inside of the joint, they will be invisible.

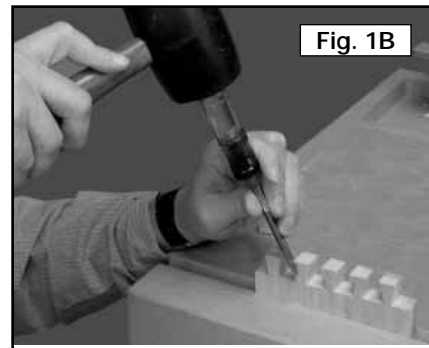
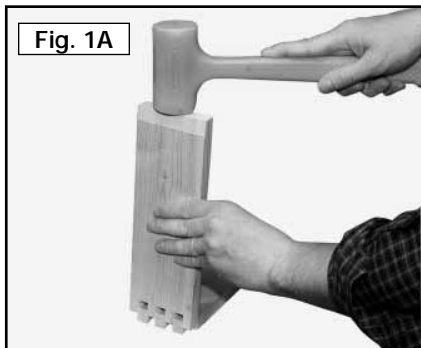

### ALTERNATE THROUGH DOVETAIL AND BOX JOINT BIT DEPTH SETTING

This method of setting your router bit depth on through dovetails or box joints is very accurate for creating pins or tails that are flush, and is especially good for inlay work. Use a board that is the same thickness as your workpiece to be joined and draw a line.

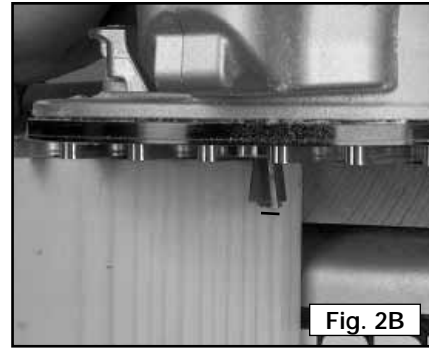
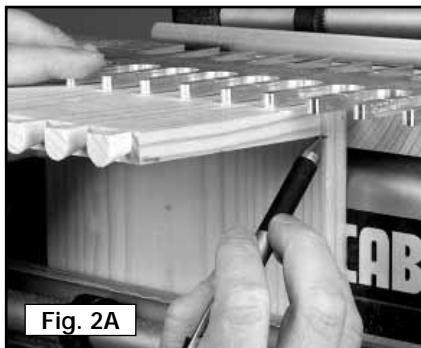

Set the router on the template and lower the router bit until it reaches the line. Make sure that the scrap material used in the horizontal position to support the template is at least as thick as the router bit depth-of-cut.

### STOP NUT FOR BRASS ADJUSTMENT KNOB

If using the same setup repeatedly, you can use a 3/8"-16 nut (A) Fig. 3A (not supplied) to keep the brass adjustment knobs from moving.

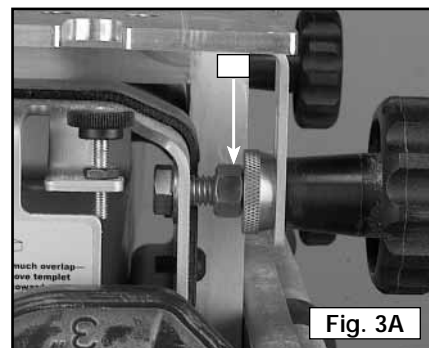

## TEMPLATES MOUNTED TO CLAMPING BOARDS

You can mount the jig templates to clamping boards and take the templates to the workpiece to make the joint. The benefits of this operation are:

1. You can maneuver a mounted template onto a large workpiece easier than clamping a large workpiece to the jig. This process allows you to join boards wider than 12" by routing a part of the joint, sliding the mounted template just past the original cut, and routing the remainder of the joint.

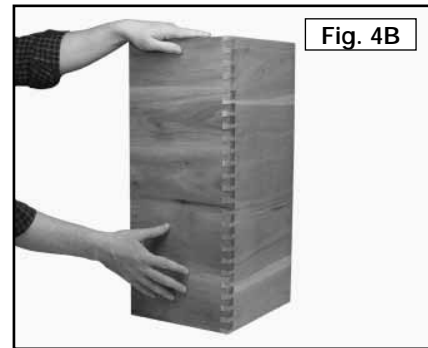
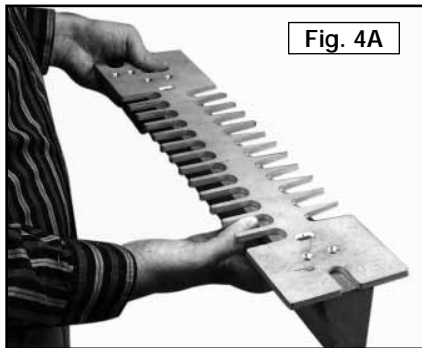

2. By using the clamping boards, you can rout boards that are too short to clamp in the jig base, allowing you to dovetail small decorative boxes.

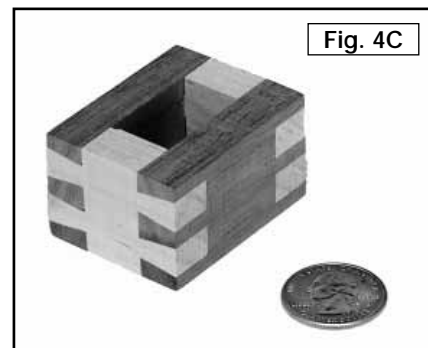

3. You can make half-blind joints in thicker wood than the jig can handle.
4. You can make steeply-angled joints with the clamping boards.
5. You can make joints using a router table by inverting the mounted templates.

---

---

## THROUGH-DOVETAILS WITH CLAMPING BOARDS

You can use both the normal through-dovetail template (included with the 4212 Jig and the 4213 Accessory Kit), and the miniature through-dovetail template (included with the 4215 Accessory Kit) with a clamping board.

**NOTE:** You can modify these clamping board methods to make box joints.

### SETUP

- Step 1** - Make a clamping board 2" x 3" x 19". Make sure that all four sides are square (You may need to glue thinner sections of wood together and plane them to make the 2" board).
- Step 2** - Drill the pilot holes for #10 screws on the face of the board as indicated in the drawing (Fig. 6A).
- Step 3** - Remove the brackets from the template (Fig. 6B).
- Step 4** - Align the lines of the template with the edges of the clamping board. You should be able to see the pilot holes in the elongated slot of the template (Fig. 6C).
- Step 5** - Drive two #10 wood screws through the elongated slots of the template into the clamping board (Fig. 6D).

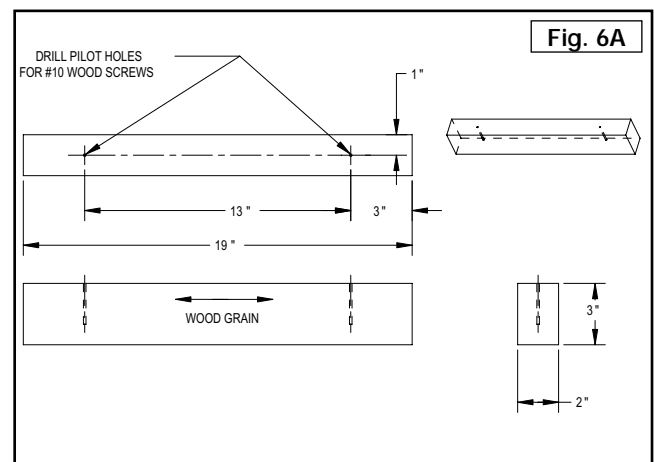

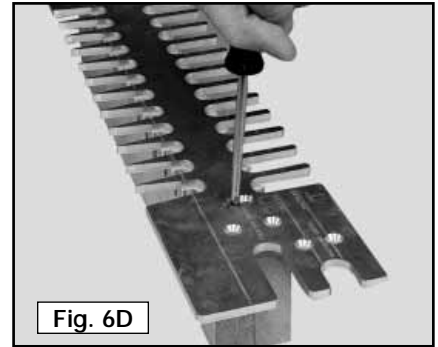
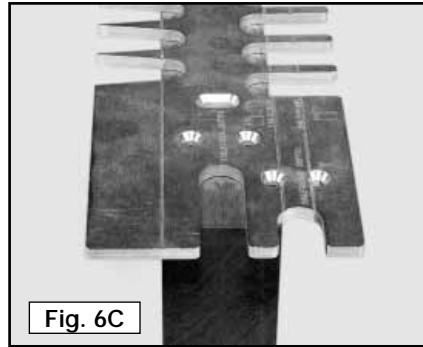
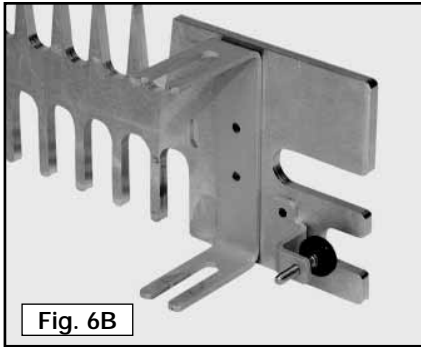

## CUTTING THE TAILS

**Step 1** - Clamp the tail board with the outside surface facing away from the clamping board (Fig. 7A). Align the tail board, using the instructions in your basic manual in the section “**OPERATION**”. Look under “**POSITIONING THE WOOD**”, **STEP 4**.

**Step 2** - This step is optional. Clamp stop blocks to the clamping board for rapid setups of repeated cuts.

**Step 3** - Use a small square and a pencil to draw a line along the bottom of the clamping board (Fig. 7B). Align the line with an edge of the tail board. (This line will be used to set up the pin board).

**Step 4** - Use the width of the pinboard to mark the depth of the router bit on the tailboard (Fig. 7C).

**⚠ WARNING** DISCONNECT THE TOOL FROM THE POWER SOURCE.

**Step 5** - Set the router bit depth, using the pencil mark from **STEP 4**.

**Step 6** - Connect your router to the power source and cut the tails (Fig. 7D).

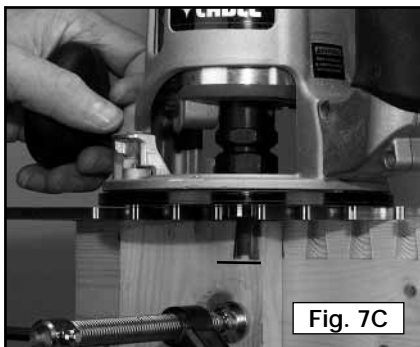
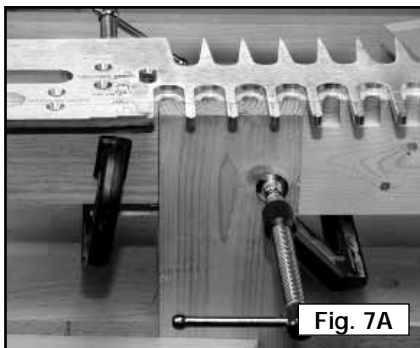

## CUTTING THE PINS

**Step 1** - Clamp the pin board with the outside surface facing away from the clamping board (Fig. 8A). Align the edge of the pin board with the line drawn in **STEP 3** of “**CUTTING THE TAILS**”.

**Step 2** - This step is optional. Clamp stop blocks to the clamping board for rapid setups of repeated cuts.

**Step 3** - Use the width of the tail board to make a pencil mark on the pin board for the depth of the router bit.

**⚠ WARNING** DISCONNECT THE TOOL FROM THE POWER SOURCE.

**Step 4** - Set the router bit depth, using the pencil mark from **STEP 3**.

**Step 5** - Connect your router to the power source and cut the pins (Fig. 8C).

**Step 6** - Remove the pin board and check the fit with the tail board (Fig. 8D).

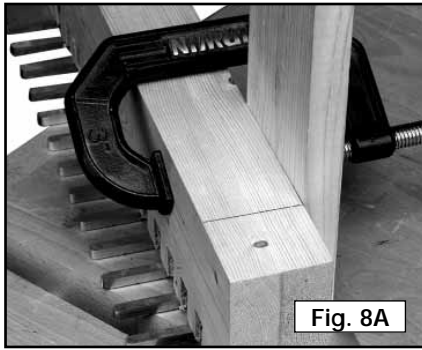

Fig. 8A

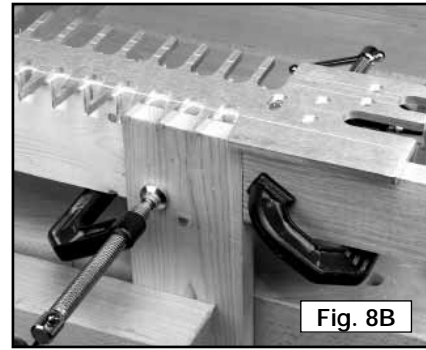

Fig. 8B

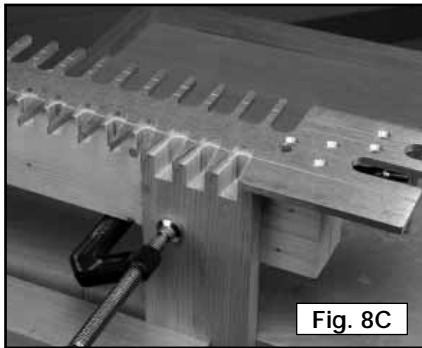

Fig. 8C

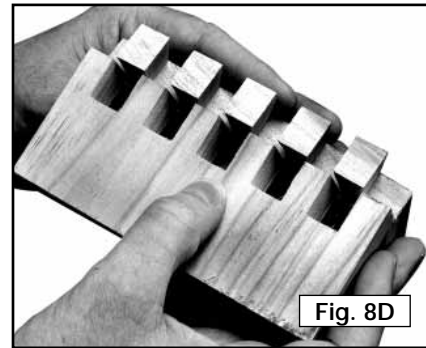

Fig. 8D

## FITTING THE JOINT

- Step 1** - Orient the template so that the "PINS" side is facing you (Fig. 9A).
- Step 2** - Loosen the two #10 screws.
- Step 3** - If the joint is too loose, move the template toward you slightly.
- Step 4** - If the joint is too tight, move the template away from you slightly.
- Step 5** - Tighten the screws loosened in **STEP 2**.
- Step 6** - Cut the pin board again and check for fit.

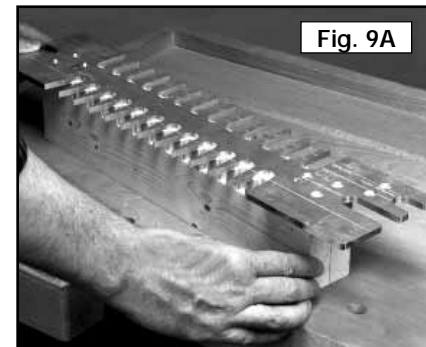

Fig. 9A

## THROUGH-DOVETAILS WITH UNLIMITED BOARD WIDTH

You can cut dovetails in boards wider than the templates mounted on clamping boards by cutting the first part of the joint, sliding the template down the workpiece, and cutting the rest of the joint.

**NOTE:** Become familiar with the procedure for cutting through-dovetails with a template on a clamping board before attempting working with unlimited board width.

### SETUP

Remove the half-blind depth bracket. Other than that, the setup is identical to the previous setup.



## CUTTING THE TAILS

- Step 1** - Clamp the tail board with the outside surface facing away from the clamping board (Fig. 10A).
- Step 2** - If the board is a width in 1" increments, (12", 13", etc.), center the edge of the board exactly between the two fingers of the template farthest to the left (Fig. 10B).
- Step 3** - If the board is not in 1" increments, take the fraction of an inch that is greater than 1" and divide it by two. Then move the tailboard to the left of the center of the fingers by that amount (Fig. 10C). **EXAMPLE:** IF the board width is 16-1/2", take the 1/2", divide it by two. You would then move the tail board to the left of the center of the fingers by 1/4" and clamp it in place.
- Step 4** - Use a piece of wood the same thickness as the pin board to mark the router bit depth.
- ⚠ WARNING** DISCONNECT THE TOOL FROM THE POWER SOURCE.
- Step 5** - Set the router bit depth, using the pencil mark from **STEP 4**.
- Step 6** - Connect your router to the power source and cut the pins as far as the template will allow.

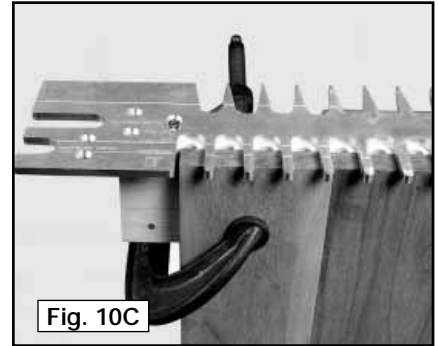
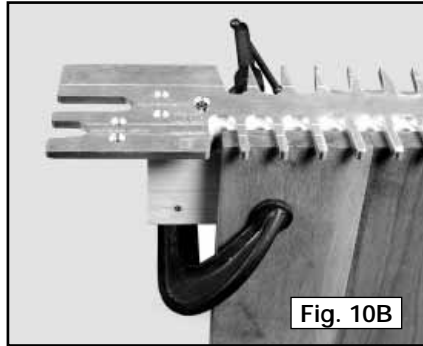
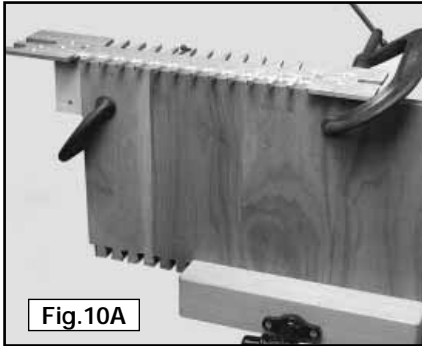

- Step 7** - Unclamp the templet, slide it down, and center the last cut between the two straight fingers and reclamp (Fig. 10D).
- Step 8** - Repeat **STEPS 6** and **7** until the pins are cut across the entire board.

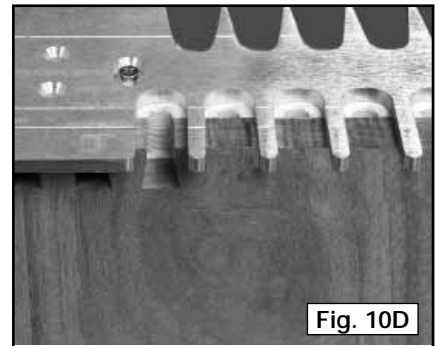

## CUTTING THE PINS

- Step 1** - Clamp the pin board with the outside surface facing away from the clamping board.
- Step 2** - If the board is a width in 1" increments, (12", 13", etc.), center the edge of the board exactly in line with the finger of the template farthest to the left (Fig. 11A).
- Step 3** - If the board is not in 1" increments, take the fraction of an inch that is greater than 1" and divide it by two. Then move the pin board to the left of center of the fingers by that amount. **EXAMPLE:** IF the board width is 16-1/2", take the 1/2", divide it by two. You would then move the tail board to the left of the leftmost finger by 1/4" and clamp it in place (Fig. 11B).
- Step 4** - Use a piece of wood the same thickness as the pin board to mark the router bit depth.
- ⚠ WARNING** DISCONNECT THE TOOL FROM THE POWER SOURCE.
- Step 5** - Set the router bit depth, using the pencil mark from **STEP 4**.
- Step 6** - Connect your router to the power source and cut the pins as far as the template will allow.

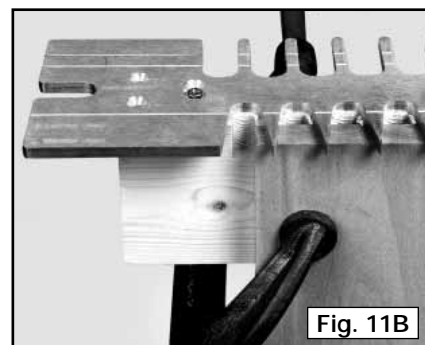
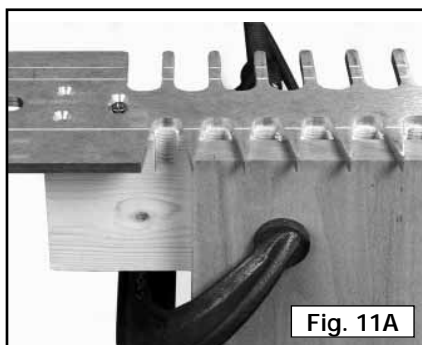

**Step 7** - Unclamp the templet, slide it down, and center the last cut between the two angled fingers and reclamp (Fig. 11D).

**Step 8** - Repeat **STEPS 6** and **7** until the pins are cut across the entire board.

**Step 9** - Remove the pin board and check the fit with the tailboard.

## **FITTING THE JOINT**

Fitting the joint is identical to the previous section (Fig. 12A).

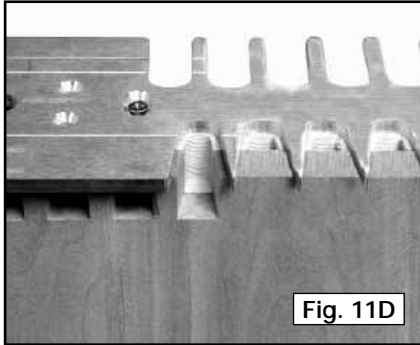

---

---

## **ALTERNATE METHOD** **THROUGH-DOVETAILS WITH UNLIMITED BOARD WIDTH**

This alternate method may be more accurate for correctly cutting the tail and pin boards.

**Step 1** - Clamp the tail and pin boards together with a 2" wide block (Fig. 13A).

**Step 2** - Use a square to align an edge of the tail and pin boards (Fig. 13B).

**Step 3** - Cut the pins and the tails as far as the templet will allow (Fig. 13C).

**Step 4** - Slide the templet, aligning the last cut in between the fingers of the templet (Fig. 13D).

**Step 5** - Repeat **STEPS 3** and **4** until both boards are completely cut.

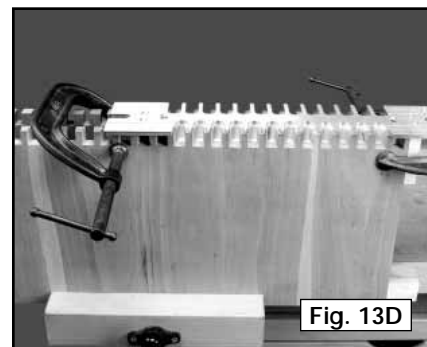
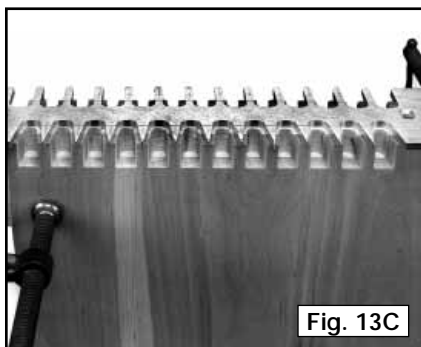
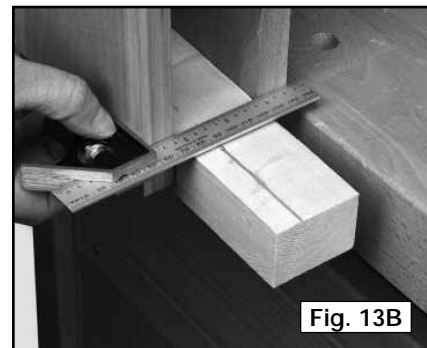
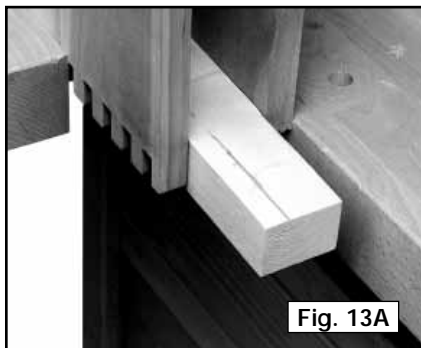

# HALF-BLIND DOVETAILS WITH CLAMPING BOARDS

You can mount your half-blind template that comes with the 4210 and 4212 jigs and the 4211 accessory kit to a board. This method, however, limits your workpiece width capacity to 8".

## SETUP

Items needed to setup for the half-blind dovetails:

1. Wood to make the clamping board parts
2. Clamps
3. 2" #10 wood screws (2)
4. 1/4-20 threaded T-nut
5. 1/4-20 x 4" bolt
6. 1/4" washer

**NOTE:** These instructions can be modified for making half-blind dovetails with the through dovetail template and for the miniature dovetail template (See the section "HALF-BLIND DOVETAILS WITH TAIL BOARDS THICKER THAN 7/8").

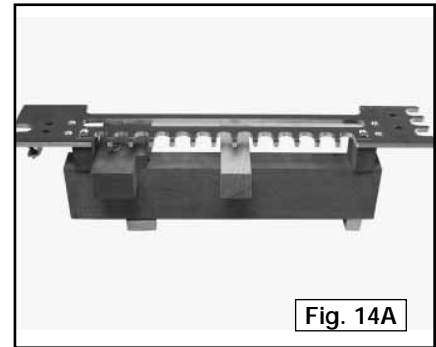

**Step 1** - Make a main clamping board 1-1/2" x 3-1/4" x 16". Square all of the sides. Make a mortise through the board and drill pilot holes for #10 wood screws (Fig. 15A).

**Step 2** - **NOTE:** Threaded inserts and #10 flathead machine screws can be used in place of the #10 wood screws.

Make the offset clamping block. Make a counterbore for the threaded T-nut (Fig. 15B).

**NOTE:** If your pin board is thinner than 3/4", modify the dimension. You may need to use extra washers to prevent the bolt from sticking out.

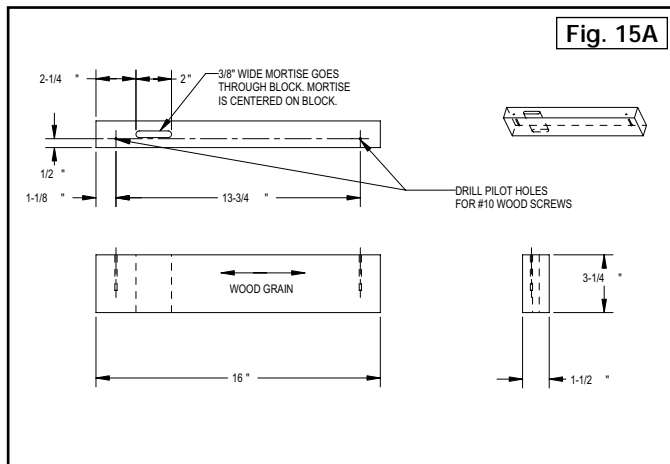

**Step 3** - Insert the threaded nut into the offset clamping block (Fig. 15C).

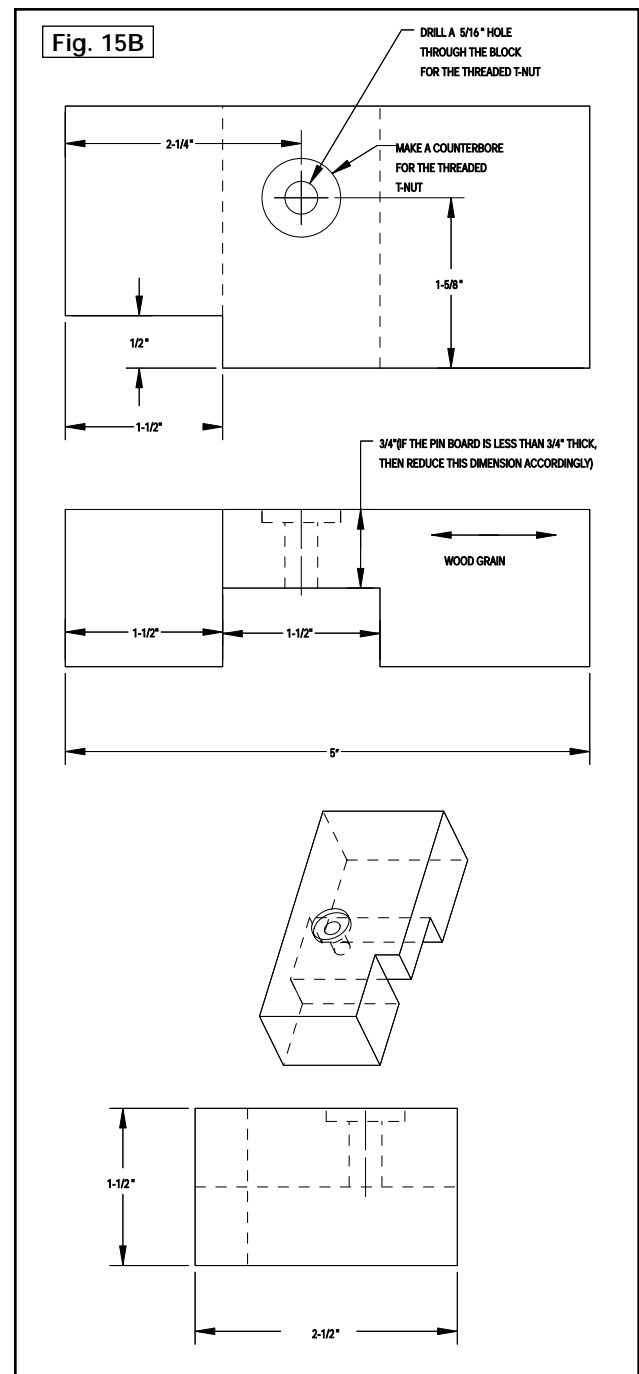
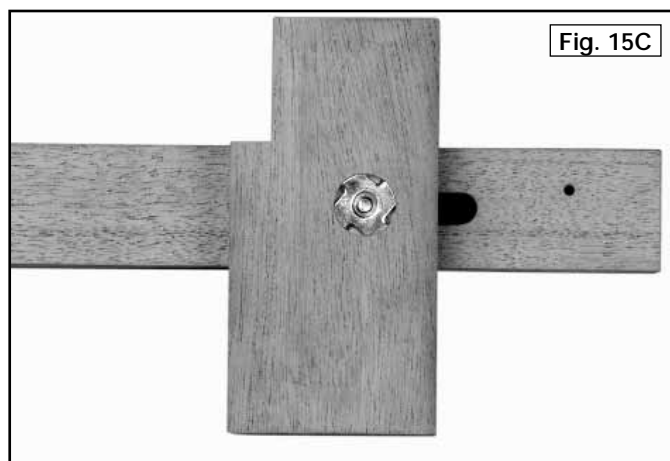

**Step 4** - Make the straight clamping block. If the workpiece is thinner than 3/4", you will need to modify the dimension (Fig. 15D).

**Step 5** - Make two thickness blocks the same thickness as the pin board. Drill a hole big enough for the wood screw to go through (Fig. 15E).

**Step 6** - Assemble the board-mounted half-blind template (Fig. 15F).

**NOTE:** You will not need to remove the half-blind depth bracket.

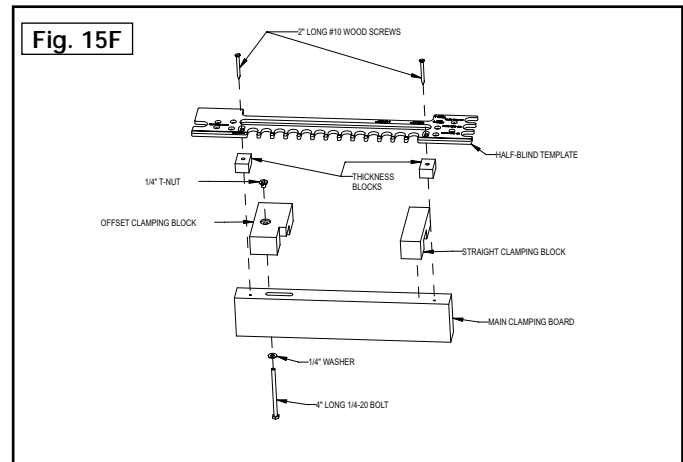
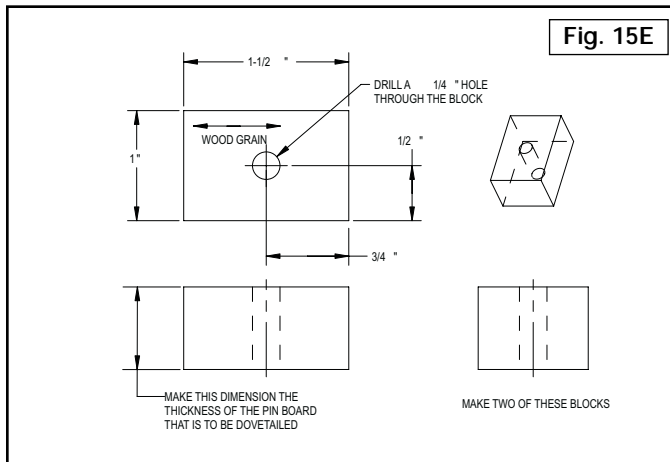
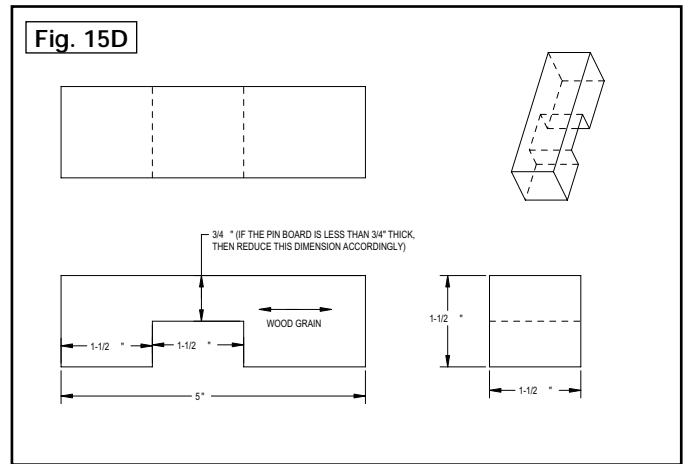

## CUTTING THE JOINT

**Step 1** - Clamp the tail board (drawer side) to the main clamping board with the outside surface facing the board (Fig. 16A).

**Step 2** - Move the offset clamping block to the right until it touches the tail board (Fig. 16B). Tighten the 1/4-20 x 4" bolt that holds the offset clamping block.

**Step 3** - Insert the pin board (drawer front) flush against the tail board and the offset clamping block (Fig. 16C).

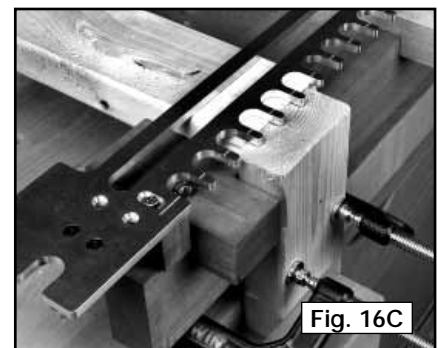
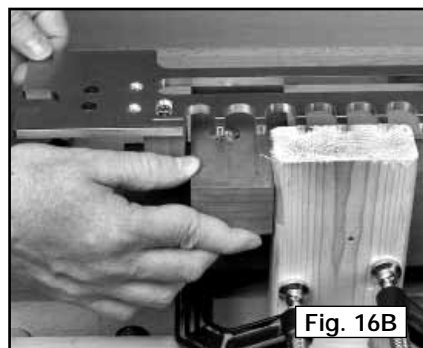
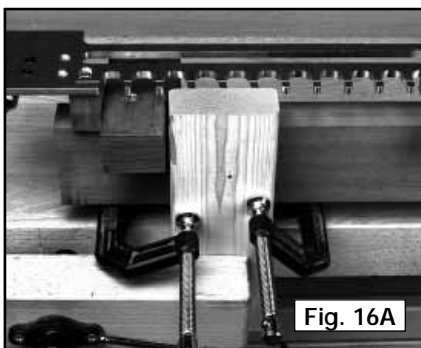

**Step 4** - Slide the straight clamping block to the left so that it contacts the pin board (Fig. 16D). Hook the straight clamping block over the front and back of the main clamping board.

**Step 5** - Secure the pin board by clamping it between the offset and straight clamping blocks (Fig. 16E).

**Step 6** - Loosen the #10 wood screws, align the template lines with the line where the pin board and tail board meet, and retighten the #10 wood screws (Fig. 16F).

**⚠ WARNING** DISCONNECT THE TOOL FROM THE POWER SOURCE.

**Step 7** - Set the router bit depth, using the bit depth guide.

**Step 8** - Cut the joint. Fitting the joint is identical to a standard half-blind dovetail.

**NOTE:** You can cut the pin and tail board separately, if you prefer.

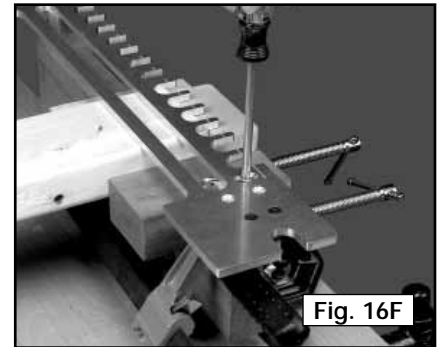
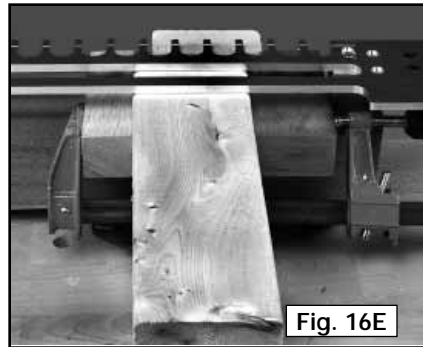
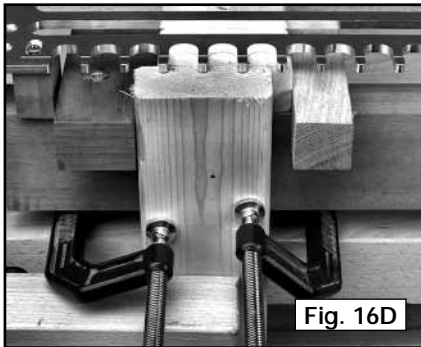

## USING A ROUTER TABLE

You can use board-mounted templates with your router table. However, the templates must be inverted. Similarly, invert all operations (setting the router bit, etc.).

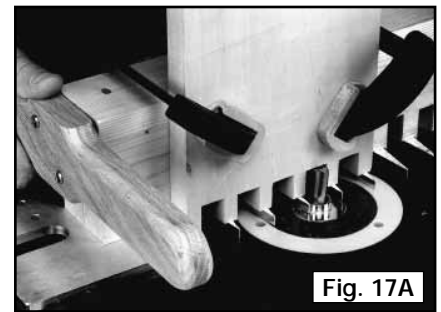

**⚠ CAUTION** Use protective handles to keep your hands away from the router bit. Grip the handles only on the opposite side of the workpiece.

Make the protective handles using the dimensions in the drawing (Fig. 17B). Round over the ends of the handles so that they are comfortable in your hands.

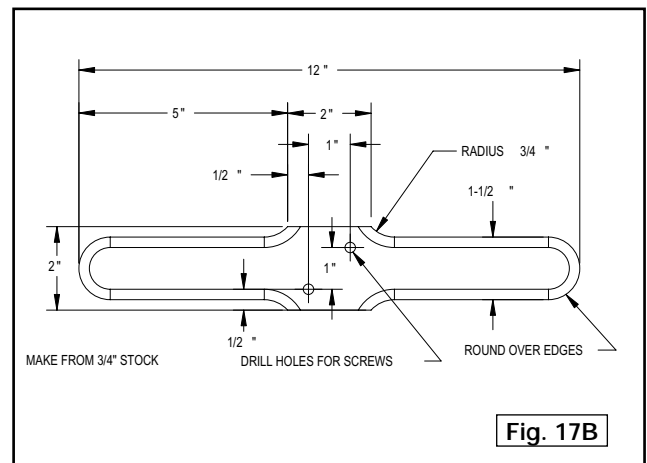

# ALTERNATE ROUTER BITS

You are not limited to using the router bits supplied with your jig. Other router bits can be used to produce a different look or to work with thicker woods. Using alternate bits can help you produce more advanced joints (inlaid dovetails, etc.). Since 1/2" shank bits are stronger and are much less prone to deflection than the 1/4" shank bits, we recommend that you use the 1/2" shank bits with the 4210 and 4212 dovetail jigs, and with the 4211 and 4213 accessory kits.

## THROUGH-DOVETAIL BITS

If you choose to purchase alternate through-dovetail bits, keep in mind the following:

1. The dovetail bit must have a 7° angle. This angle matches the tapered fingers used to guide the straight bit.
2. The sum of the diameters of the dovetail and straight bits must equal 15/16". For example, a 5/8" dovetail bit must have a 5/16" straight bit - the sum of both equalling 15/16".
3. The length of the cutter determines the maximum thickness of wood that can be cut. The length of the cutter on the dovetail bit is the maximum thickness of the pin board. The length of the cutter on the straight bit is the maximum thickness of the tail board. If your bits have 1" cutters, you can make through-dovetails with 1" thick boards.
4. Purchase bits that will not cut into the template guides. The template guide used with the dovetail bit has an inside diameter of 21/32". Use bits that will fit into this dimension. Some larger bits might work, but with minimal depth (Fig. 18A).
5. The inside diameter of the template guide used with the straight bit is 17/32". Use straight bits that are smaller than that dimension.

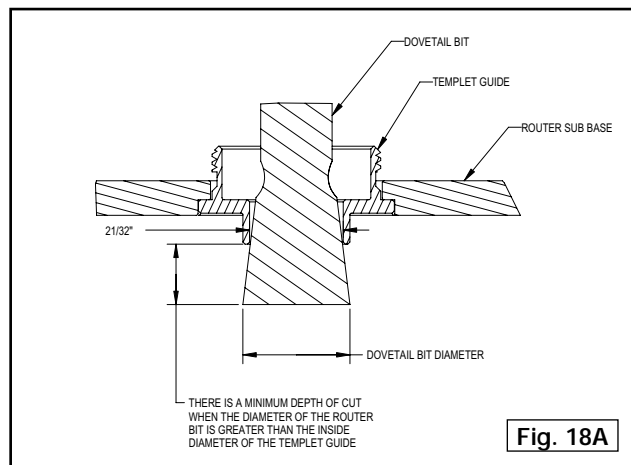

<b>THROUGH-DOVETAIL BIT COMBINATIONS (READILY AVAILABLE)</b>	
<b>DOVETAIL BIT DIAMETER</b>	<b>STRAIGHT BIT DIAMETER</b>
3/4"	3/16"
5/8"	5/16"
9/16"	3/8"
17/32"	13/32"

## HALF-BLIND DOVETAIL BITS

The difference in using alternate bits and standard bits in making half-blind dovetails is in the depth-of-cut.

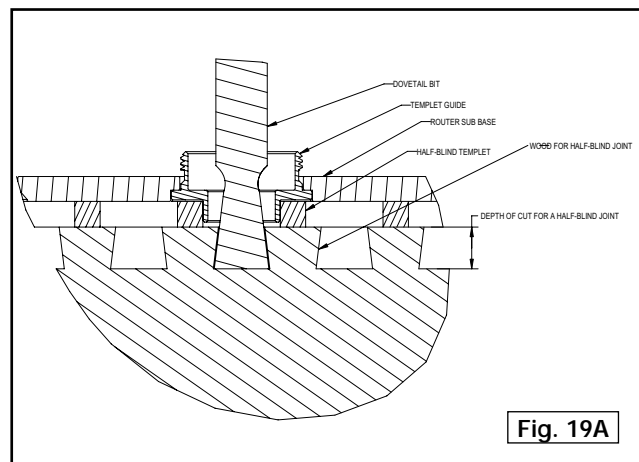

Some items to consider when purchasing alternate bits for half-blind dovetails are:

1. A shallow angle of the bit requires a deeper cut. A steeper angle requires a shallower cut.
2. The diameter of the bit should be slightly greater than 1/2". The greater the diameter, the deeper the cut.
3. The bit should have a cutting length at least as long as the cutting depth.

**NOTE:** When using alternate bits, ensure that the pin board (drawer front) is thicker than the depth of cut.

**NOTE:** When using alternate bits, ensure that the bit will not cut into the base of the jig. For deep cuts, take out most of the material with a straight bit, then follow up with the half-blind dovetail bit.

<b>HALF-BLIND DOVETAIL BIT (READILY AVAILABLE)</b>	
<b>DOVETAIL BIT</b>	<b>APP. DEPTH OF CUT</b>
17/32", 7°	13/32"
17/32", 14°	3/16"
9/16", 7°	3/4"
5/8", 14°	9/16"

## **HALF-BLIND DOVETAIL BITS WITH THE TAILS AND PINS CUT SEPARATELY**

Using two different-sized dovetail bits to make half-blind dovetails requires separate cuts, similar to cutting the rabbeted half-blind dovetail. This method provides a more hand-cut look and is an important step in creating inlaid half-blind dovetails.

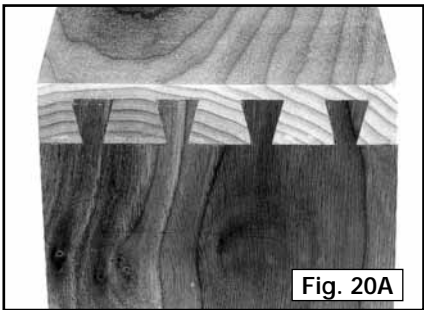

**Fig. 20A**

Some items to consider:

1. The two bits must have the same angle.
2. A shallower angle requires a deeper cut, while a steeper angle requires a shallower cut.
3. When the diameters of the two bits are added together, the sum must be slightly greater than 1". The closer the sum is to 1", the shallower the depth of cut will be. The larger the sum, the deeper the cut.

<b>BIT COMBINATIONS FOR SEPARATE HALF-BLIND CUTS (READILY AVAILABLE)</b>		
<b>LARGER BIT</b>	<b>SMALLER BIT</b>	<b>APPROX. DEPTH-OF-CUT</b>
3/4", 14°	1/2" 14°	9/16"
5/8", 14°	1/2" 14°	3/8"
5/8", 7°	17/32", 7°	7/8"
5/8", 7°	9/16", 7°	1"
9/16", 7°	17/32", 7°	5/8"

## **SETUP**

The only difference between cutting this joint and cutting the standard half-blind is the use of two router bits. If you use one router, you will have to set the depth-of-cut for each router bit. You can make a simple depth guide as illustrated in Fig. 21A. If you have two routers, you will not have to go through the process of changing the bit each time you make a different cut. This method requires, however, two 3/4" OD template guides and two template guide locknuts, available from Porter-Cable.

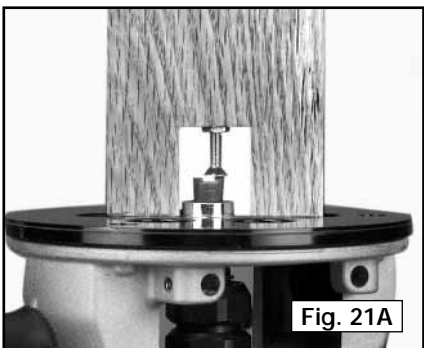

**Fig. 21A**

## **CUTTING THE TAILS**

Cut the tail board (drawer side) similar to cutting the rabbeted half-blind dovetail, but remove the spacer and move the left offset guide directly against the tail board.

**NOTE:** Support the template with a scrap workpiece thick enough to prevent the cutter from contacting the base.

## **CUTTING THE PINS**

Cut the pin board (drawer front) similar to cutting the rabbeted half-blind dovetail. (If you use the alternate method of aligning the pin board with secondary board. Make sure the secondary board does not have a rabbet).

**NOTE:** Ensure that the pin board (drawer front) is thicker than the depth of cut to prevent the cutter from contacting the base.

## **FITTING THE JOINT**

Fit the joint the same as you would a standard rabbeted half-blind dovetail.

**NOTE:** If a change in depth-of-cut is required, change it on both bits.

---

---

## **BOX JOINT BITS**

You can make box joints with different diameter router bits for the two workpieces. The process is identical to making standard box joints except that you will need to change the bit for the second board. Two routers will make this job easier. However, this two-router method will require two 3/4" OD template guides and two template guide lock nuts, available from Porter-Cable.

In selecting straight bits for these modified box joints, keep in mind the following:

1. The sum of the diameters of the two straight bits must equal 1".
2. The length of the bit used to cut the first board determines the maximum thickness of the second board. (Example: if a 3/8" diameter bit used on the first board has a 1/2" long cutter, the maximum thickness of the second board would be 1/2").

<b><u>BOX JOINT BITS (READILY AVAILABLE)</u></b>	
<b>LARGER STRAIGHT BIT</b>	<b>SMALLER STRAIGHT BIT</b>
1/2"	..... 1/2"
9/16"	..... 7/16"
5/8"	..... 3/8"

---

---

## **DOVETAIL DADO BITS**

Any dovetail bit can be used to make dovetail dados (sliding dovetails) as long as the bit does not cut into the template guide or the base of the jig. The process is identical to that of the standard dovetail dado. Also, you can use template guides smaller than 3/4" OD which will have the effect of making the dado slot wider than the bit diameter.

**NOTE:** Any template guide bushing surface must not extend more than 1/4" from the base.



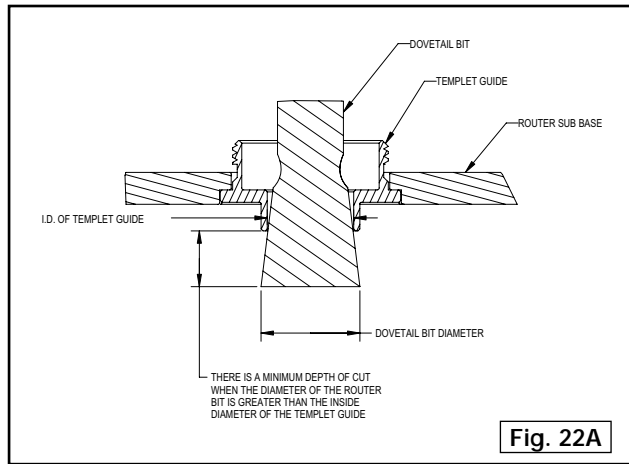

Fig. 22A

Cutting a dado with a templet guide that has an OD smaller than 3/4" requires two passes.

1. Start on the left side. Keep the router toward the back edge of the dado slot, and cut to the right until you have completed the cut.
2. Start on the right side. Keep the router towards the front edge of the dado slot, and cut to the left until you complete the cut.
3. Leave the router in the dado slot until the bit stops spinning.

**NOTE:** For deep cuts, use a straight bit first.

**NOTE:** Cut the tenon just as you would a standard tenon.

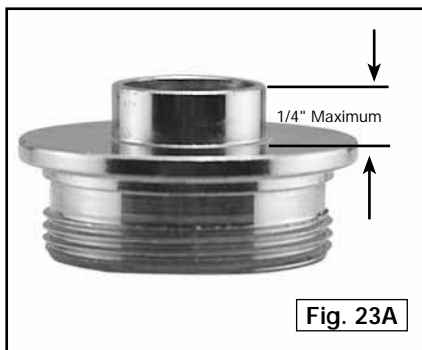

Fig. 23A

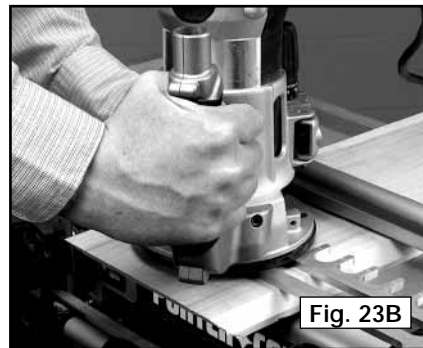

Fig. 23B

## HALF-BLIND DOVETAILS WITH TAIL BOARDS THICKER THAN 7/8"

For tail boards thicker than 7/8", you can use the template normally used for through dovetails (instead of that used for half-blind dovetails) to provide deeper pins and tails (Fig. 24A). The procedure is the same as that for a normal half-blind dovetail.

**NOTE:** Use the "half-blind" line for aligning the template.

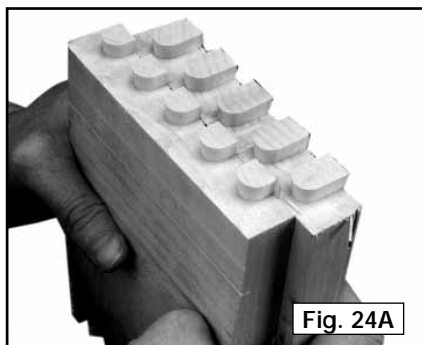

Fig. 24A

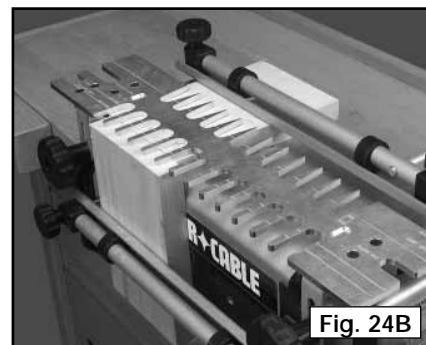

Fig. 24B

With the wood clamped to the base of the jig, the maximum thickness will be 1-1/8". By using a templet mounted to a clamping board, you can use much thicker wood, producing a strong joint.

## MITERED THROUGH-DOVETAIL

You can make a through-dovetail with a mitered edge, creating a molded edge that goes the whole way to the joint. This joint is very attractive on serving trays or decorative boxes without



**NOTE:** Depending on the depth of the molded edge, you may want to make the boards slightly wider to account for the molded depth. If so, mount the tail board so that the mitered edge will end with the thicker half-pin. With the offset guide set against the tail board, the pin board will automatically be cut correctly.

## CUTTING THE TAILS

Cut the tails as you would a standard through-dovetail, except do not make the tail cut on the edge from the proposed

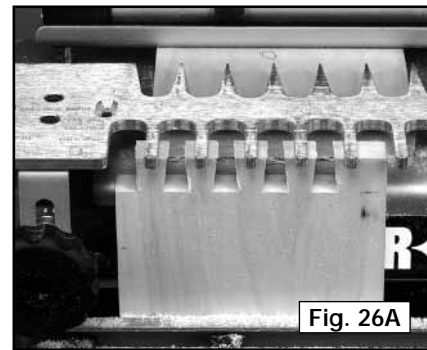

## CUTTING THE PINS

- Step 1** - Cut all the pins normally.
- Step 2** - Remove the template, turn it horizontally so that the straight fingers are facing you.
- Step 3** - Adjust the board so that the edge where the miter will be cut is to the left.
- Step 4** - Adjust the board so that only the triangular part of the half-pin will be cut off with the router and straight bit, leaving a squared-off pin (Figs. 27A and 27B).
- Step 5** - For repeated cuts, slide the left offset guide until it touches the pin board and secure it.
- Step 6** - Cut the triangular area off (Fig. 27C).

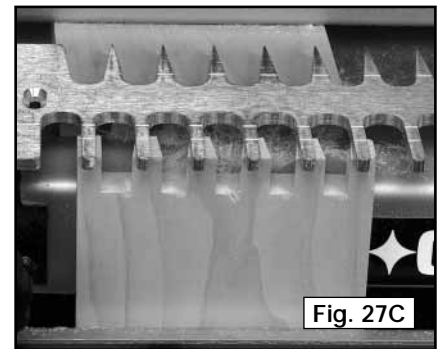
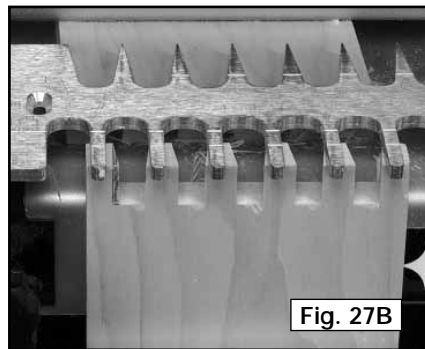
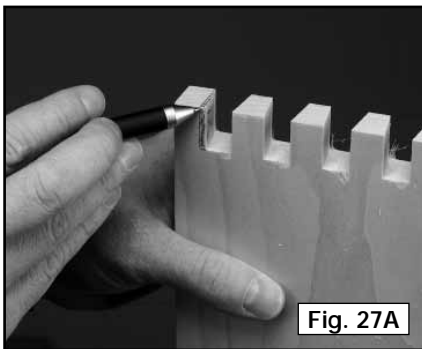

## MITERING THE PINS

- Step 1** - On the inside surface, use a square and pencil to draw a line from the base of the pins to the edge where the miter will be cut (Fig. 28A).
- Step 2** - Use a table saw with the miter gauge set to 45° to miter the squared-off half pin (Figs. 28B and 28C).

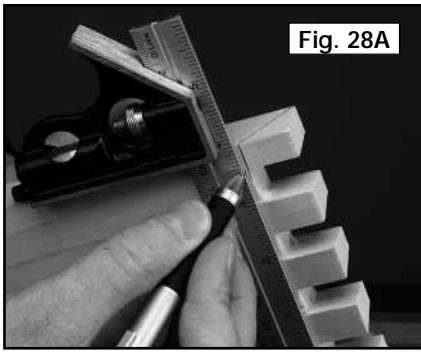

Fig. 28A

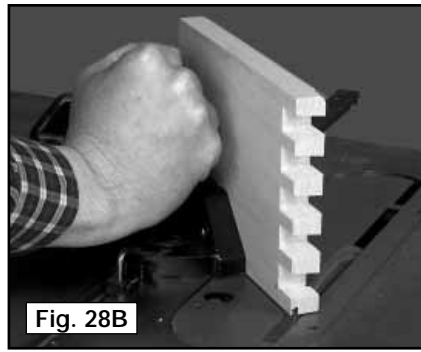

Fig. 28B

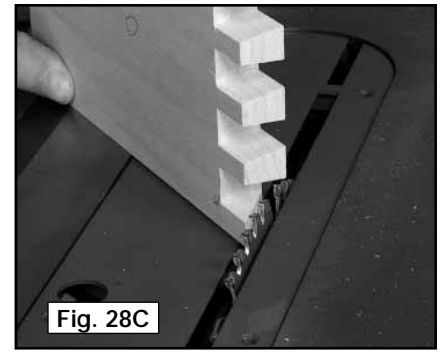

Fig. 28C

## MITERING THE TAILS

- Step 1** - On the inside surface, use a square and pencil to draw a line from the base of the tails to the edge where the miter will be cut (Fig. 29A).
- Step 2** - Set the table saw blade so that the height of cut of the saw blade is the same as the thickness of the mitered half-pin.
- Step 3** - Use a table saw with the miter gauge set to 45° to miter the tails. You will need to make several passes to cut out the material (Fig. 29B).

**NOTE:** A dado head could be used to make this cut in one pass.

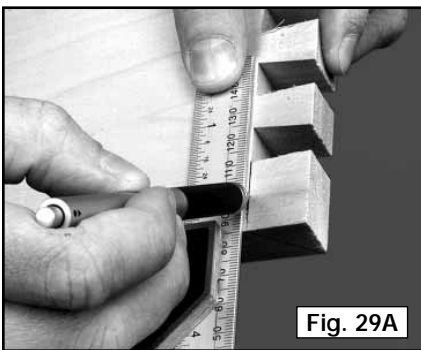

Fig. 29A

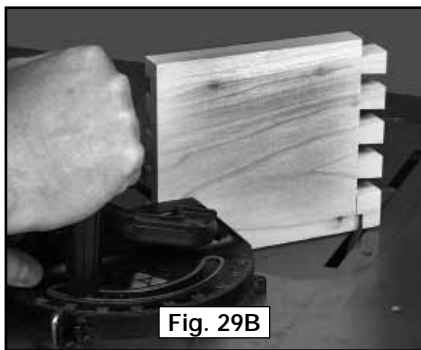

Fig. 29B

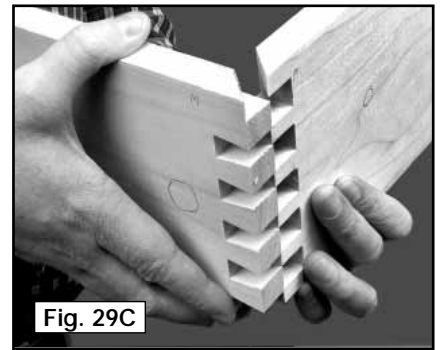

Fig. 29C

## FITTING THE JOINT

You may need to trim the miter cuts by hand for a good fit. Files, chisels, shoulder planes, and rabbet planes work well. Otherwise, adjust the tightness of the joint the same as you would for a normal through dovetail.

## THROUGH-DOVETAIL, SKIPPED-PIN METHOD

This method is very similar to cutting standard through- dovetails (Fig. 30A).

### CUTTING THE TAILS

Cut the tails as normal, except do not cut into the areas where you do not want a pin to appear.

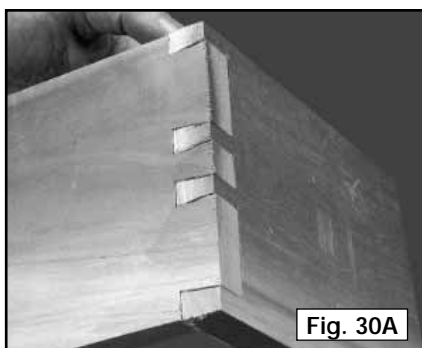

Fig. 30A

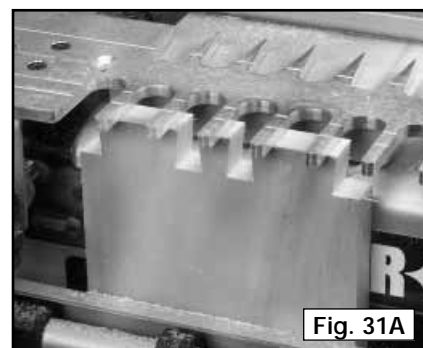
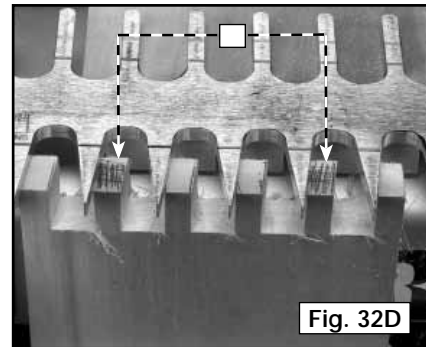
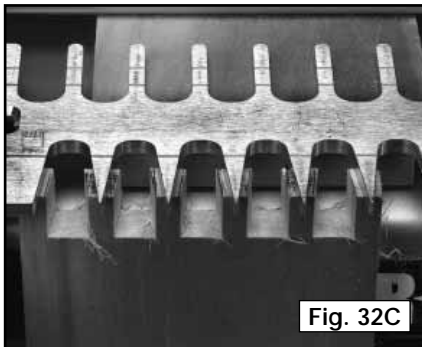
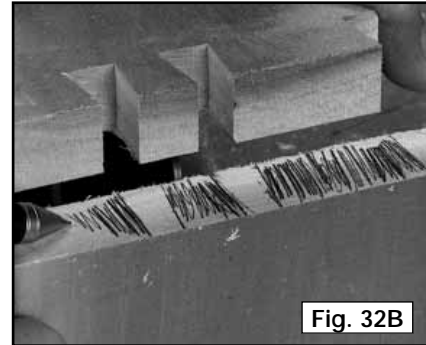
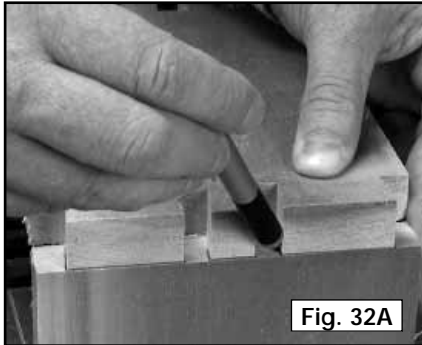

Fig. 31A

## CUTTING THE PINS

- Step 1** - Hold the pin board against the tail board and mark the edges of the tails on the end of the pin board (Fig. 32A).
- Step 3** - Shade in the areas on the end of the pin board where the tails will be (Fig. 32B).
- Step 4** - Cut all the pins (Fig. 32C).
- Step 5** - Slide the pin board to the right 1/4" (Fig. 32D).
- Step 6** - Cut in between the fingers of the template to cut only in the shaded area (A) Fig. 32D.  
Repeat **STEPS 4** and **5** until all of the material between the pins has been removed.



## FITTING THE JOINT

Fit the joint the same as you would a standard through

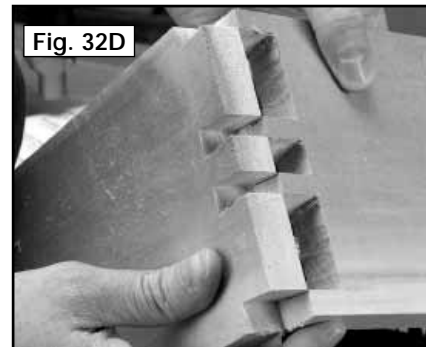

---

---

## HALF-BLIND DOVETAIL, SKIPPED PIN METHOD

This method is similar to making standard half-blind dovetails, except that the tails and pins are cut separately.

Cut the tails first. Use a scrap workpiece (thick enough to prevent contact with the base of the jig) to support the template.

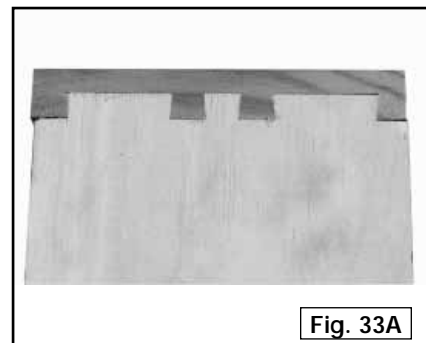

**Step 1** - Make a climb cut from right to left.

**Step 2** - Cut only between the fingers where you want the pins to be (Fig. 34A).

**Step 3** - Use the router to round over the ends of the cuts (Fig. 34B).

**Step 4** - The joint will hide any accidental excess material cut (A) Fig. 34C.

**Step 5** - Use a pencil to mark the location of the ends of the templet fingers on the wood (Fig. 34D).

**Step 6** - Remove the templet. Install the half-blind templet so that its straight edge is facing you.

**Step 7** - Adjust the template back and forth to align the edge of the template with the marks on the wood(B) Fig. 34E.

**Step 8** - Make a cut from left to right removing the remainder of the excess material (Fig. 34F).

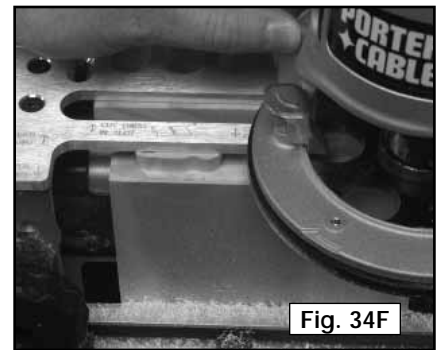
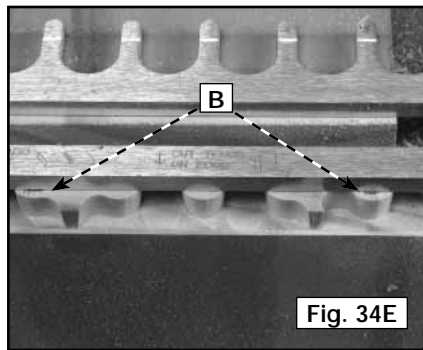
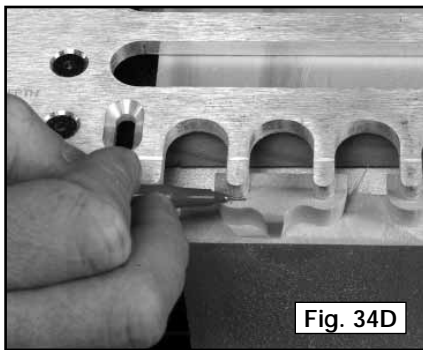
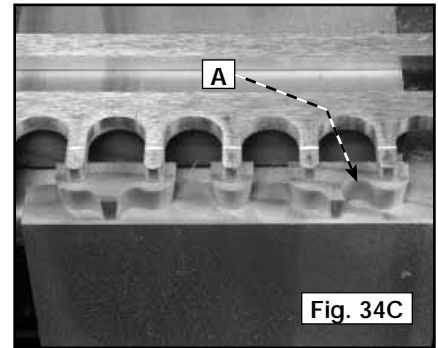
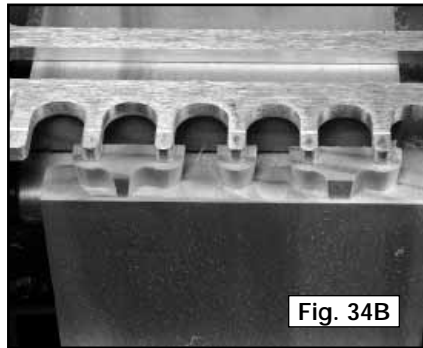
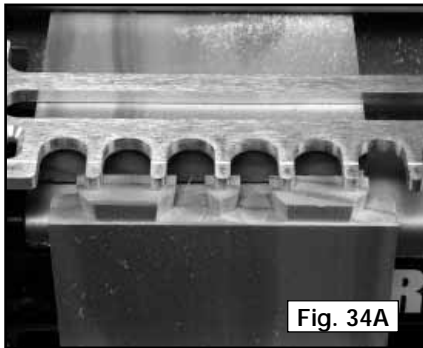

## CUTTING THE PINS

**Step 1** - Cut the tails. Clean out all of the areas between the fingers(Fig. 35A).

**Step 2** - Use a pencil to mark the location of the half-circle between the fingers of the templates (C) Fig. 35B.

**Step 3** - Remove the pin board and hold it next to the tail board.

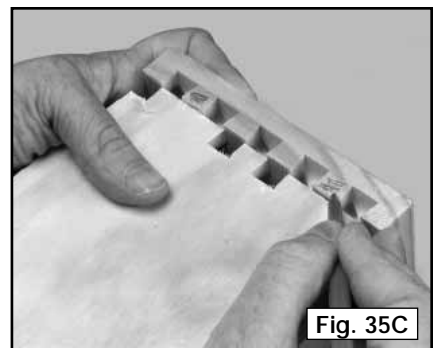
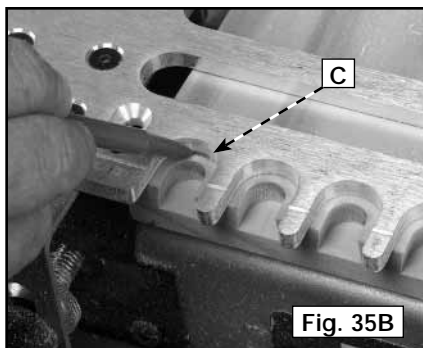
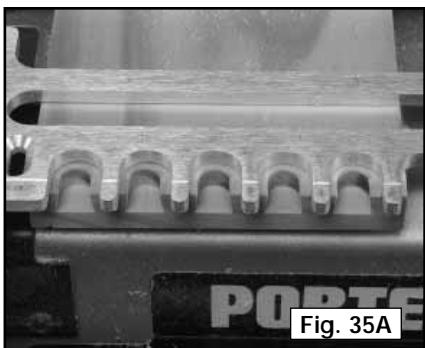

- Step 4 - Shade the pins that will be removed (Fig. 35C).
- Step 5 Place the pin board back in the jig.
- Step 6 Install the half-blind template so that its straight edge faces you.
- Step 7 Adjust the pin board so that the marks align with the straight edge of the templet (D) Fig. 35D.
- Step 8 Make the cuts with the router to remove the shaded pins (Fig. 35E).
- Step 9 Remove all excess material.
- Step 10 If you remove a bit more material than necessary, remember that it will be hidden in the joint (E) Fig.

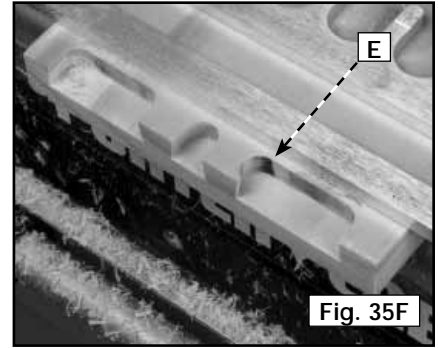
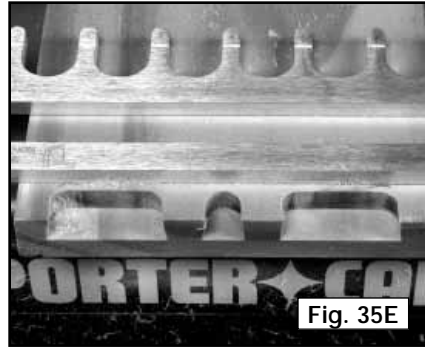
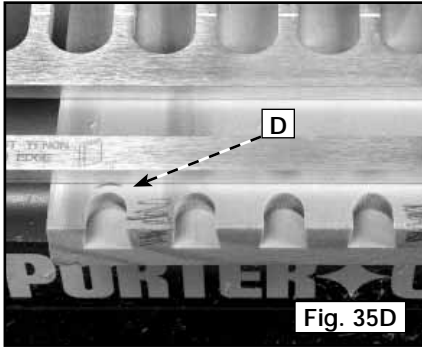

## FITTING THE JOINT

Fit the joint the same as you would the half-blind dovetail.

## SAW KERF ALLOWANCE METHOD

An effective way to match the grain in a decorative box is to make the box from one piece of wood and then cut the lid with a table saw. However, if the dovetails are evenly spaced, they may be unattractive because the saw kerf removed needed material.

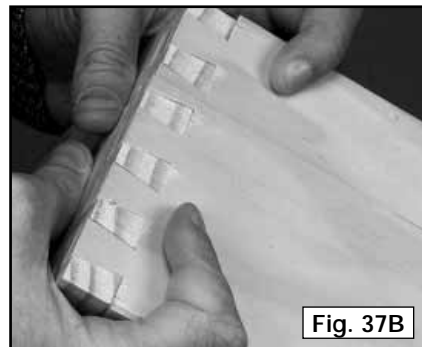
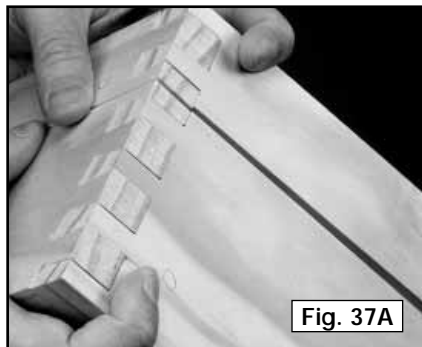

**NOTE:** For this method, you will need a spacer block equal to the thickness of the saw kerf, typically 1/8" on a standard saw blade. Also, make the boards wider than the final size of the box by the same thickness.

**NOTE:** This method is very similar to making standard through-dovetails.

## CUTTING THE TAILS

- Step 1** - Center and clamp the tailboard as normal, but use the spacer on the left side of the board (A) Fig. 38A. (The spacer will cause the board to move slightly off center to the right).
- Step 2** - Mark between the two fingers on the template where you want the kerf to be (B) Fig. 38B.
- Step 3** - Cut the tails from the far left to the right. **Stop at the mark** (Fig. 38C).
- Step 4** - Remove the spacer and slide the tail board to the left.
- Step 5** - Cut the rest of the tails, starting with the tail that has the mark (Fig. 38D).

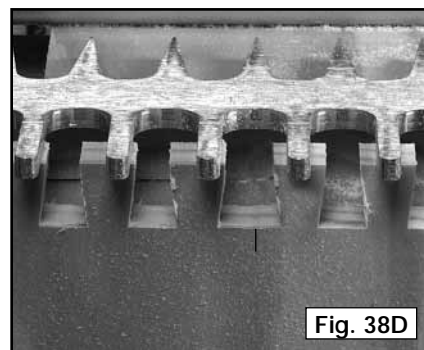
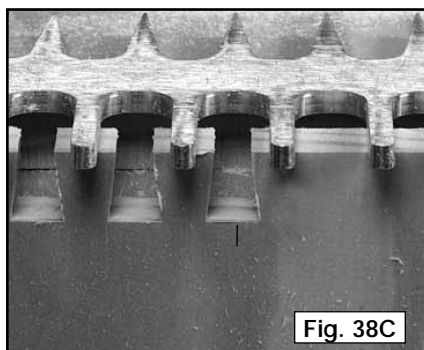
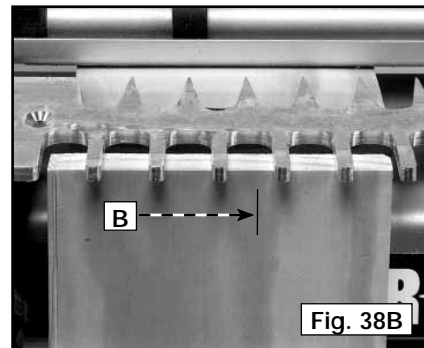
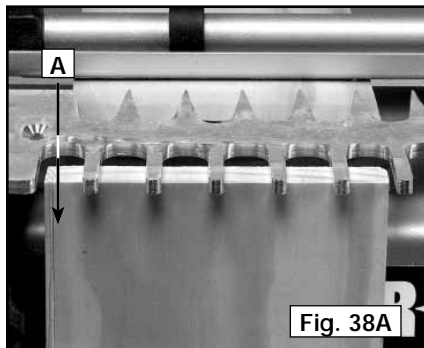

## CUTTING THE PINS

- Step 1** - Clamp the pin board with the spacer on the left (Fig. 39A).
- Step 2** - Mark the pin the saw kerf will go through (Fig. 39B). (Use the tail board for comparison.)
- Step 3** - Cut the tails from left to right. **Stop right before the mark** (Fig. 39C).

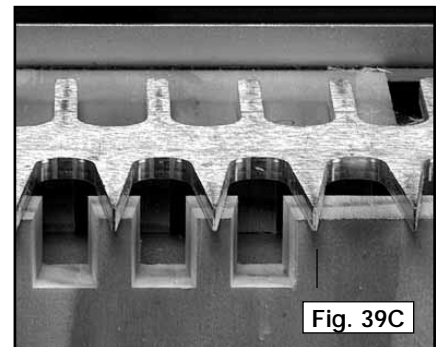
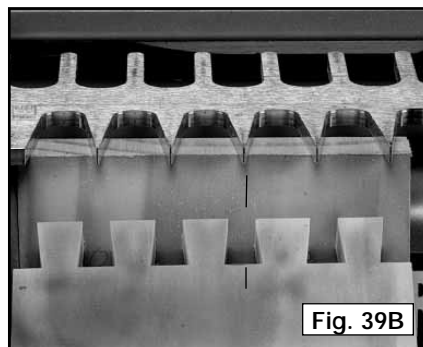
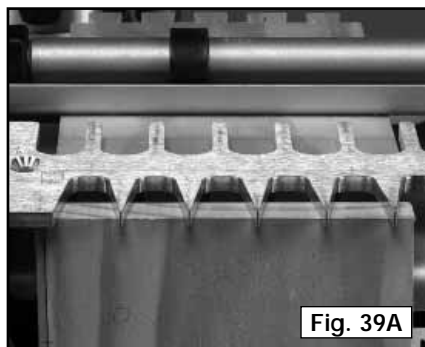

**Step 4** - Remove the spacer and slide the pin board to the left (Fig. 39D).

**Step 5** - Start with the pin to the right of the mark and cut the rest of the pins to the right (Fig. 39E).

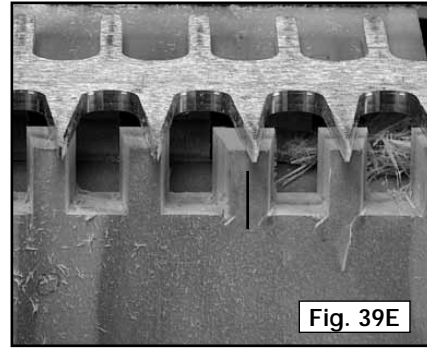
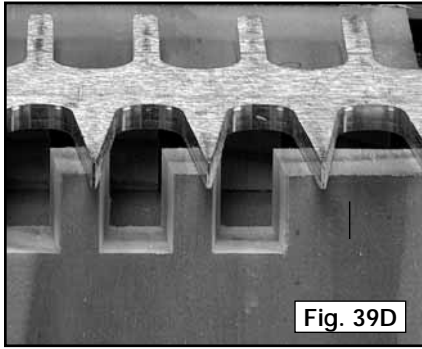

## **FITTING AND CUTTING THE JOINT**

Fitting the joint is the same as fitting the standard dovetail. Once the box is glued and dried, separate the box lid and bottom with a table saw.

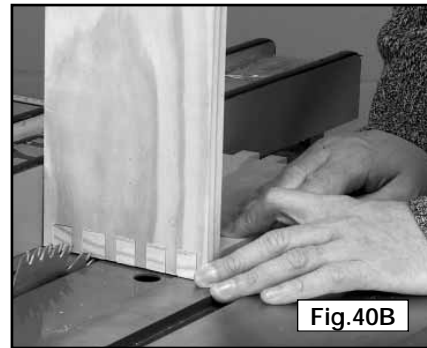

---

---

## **MULTIPLE SPACER METHOD**

The saw kerf allowance method can be modified by using multiple spacers on the same joint to create more varied spacing of the pins and tails.

However, when removing or adding a spacer, continue cutting the NEXT tail (instead of cutting the SAME tail as described in "CUTTING THE TAILS" - STEP 5), and continue with the SAME pin (instead of cutting the NEXT pin as described in "CUTTING THE PINS" - STEP 5).

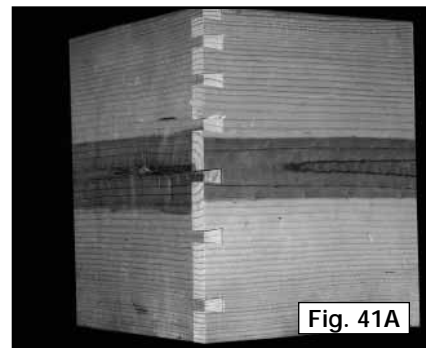

---

---

## **END-TO-END JOINTS**

You can use the 4200 series dovetail jigs to join boards end-to-end to increase length and to make visually interesting larger panels.

### **BOX END-TO-END JOINTS**

End-to-end and standard box joints are the same except in the joining of the boards. You can use any depth of cut with your router as long as you use the same depth on both boards.

**NOTE:** When you set your depth-of-cut, set it so that the bit won't cut into the base of the jig.

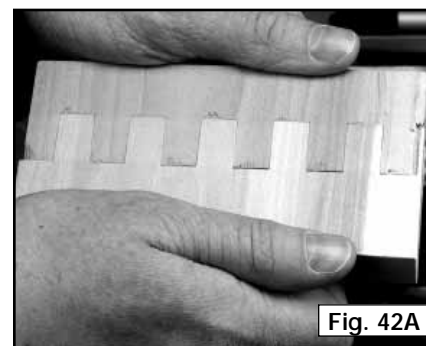



The standard joint is shown in Fig. 42B and the end-to-end joint is shown in Fig. 42C.

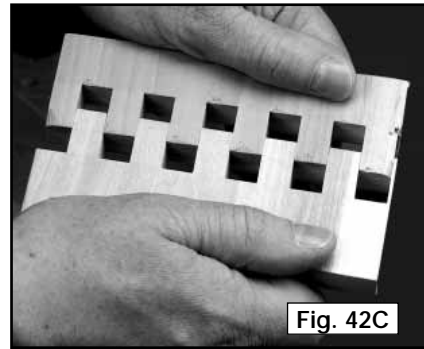
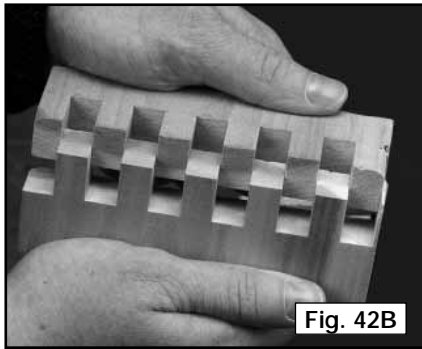

## DOVETAIL END-TO-END JOINTS

A dovetail end-to-end joint is a combination of a box joint and a half-blind dovetail joint. The workpieces are mounted to the jig in the same way as for a box joint. However, the router bit and bit depth are set-up for a half-blind dovetail.

**NOTE:** The tightness of the joint is adjusted by the depth of the router bit.

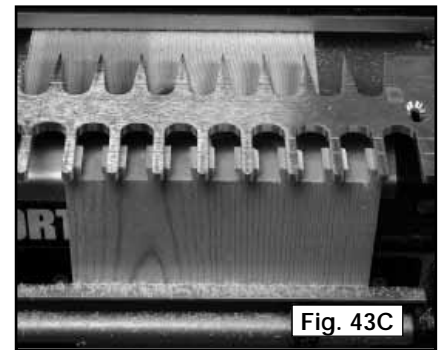
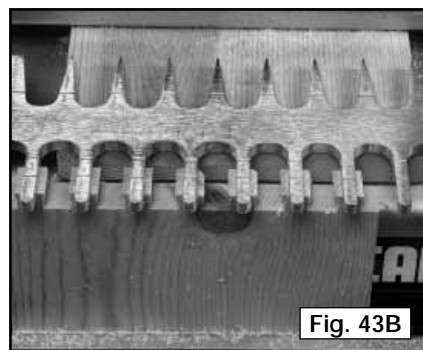
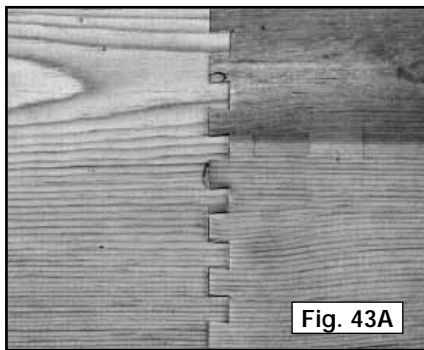

---

---

## DRAWERS WITH DOVETAIL DADOS

Drawers can be made with dovetailed dados (sliding dovetails). Lay out the parts as shown in Fig. 44A. Assembled, the drawers will look the same as Fig. 44B

The drawer front will have two dados, one for each drawer side.

The drawer sides will have a tenon on the front end and a dado near the rear facing the center of the drawer.

The drawer back will have a tenon on each end.

The drawer front and sides will have a cut groove to accept the drawer bottom.

The drawer back will be cut narrower for ease of inserting the drawer bottom into the drawer.

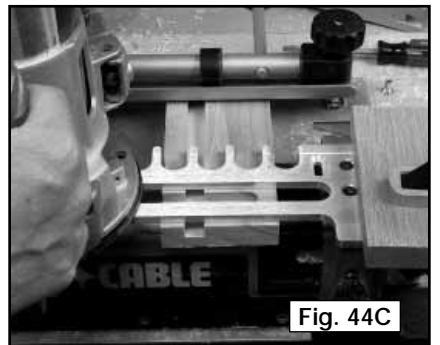
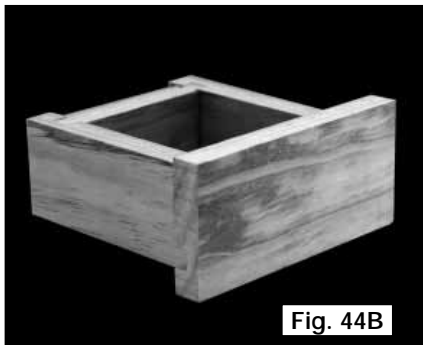
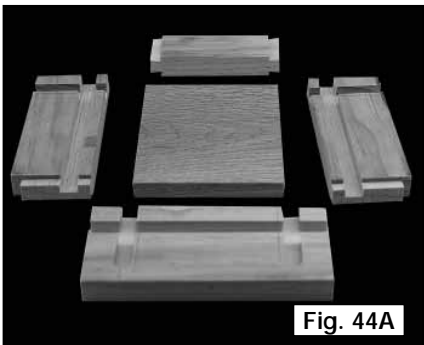

To hide the joint, cut the dado normally, but stop before you reach the top (Fig. 44C).

**NOTE:** You can clamp a stop to the template if you are making multiple cuts (Fig. 44C).

To further hide the joint, you can cut the top corner of the tenon off (Fig. 44A).

**NOTE:** If the sides and back are the same thickness, you can cut all of the tenons with one setup.

# WOODEN HINGES

A wooden hinge can be used to make hinged table leaves or hinged legs for a collapsible table. The hinge pins are normally made of stainless steel, but you can use other materials, including wood for that purpose.

## 180° HINGES WITH A DRILLED HOLE

The workpiece for this simple hinge must be narrow enough to make the hole for the hinge pin with a drill bit. This hinge has at least a range of motion of 180° (Figs. 45A and 45B).

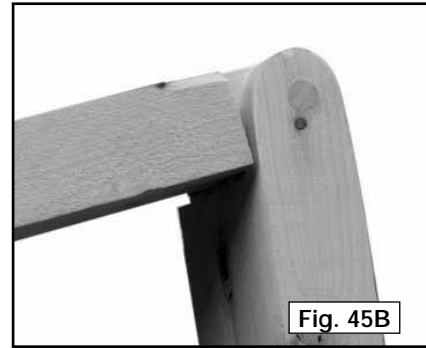
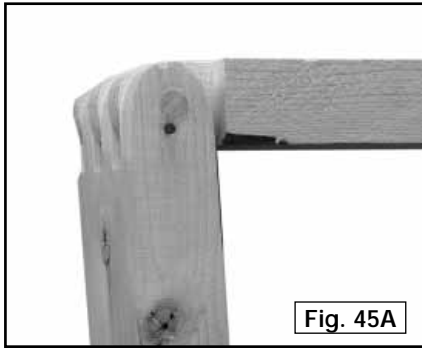

- Step 1** - Round over the ends of the two workpieces (Fig. 45C).
- Step 2** - Use a drill press to drill a hole in the center of each board for the hinge pin (Fig. 45D).
- Step 3** - Make an end-to-end box cut. (Make the depth-of-cut slightly deeper than the thickness of the boards (Fig. 45E).
- Step 4** - Make the length of the hinge pin narrower than the width of the boards
- Step 5** - Hold the boards together, align the holes, and insert the pin (Fig. 45F).
- Step 6** - Glue wooden plugs in the workpiece to hold the pins in place.(Fig. 45G).
- Step 7** - Cut off the protruding part of the plugs and sand (Fig. 45H).

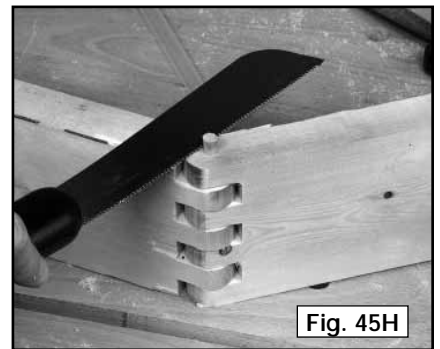
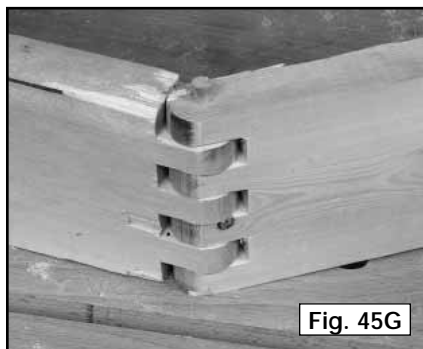
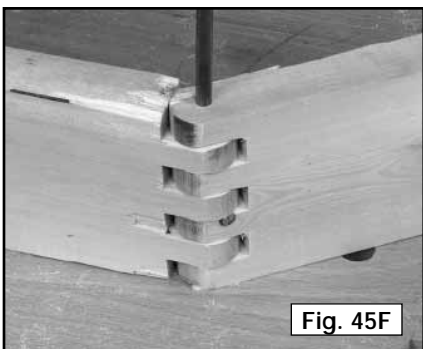
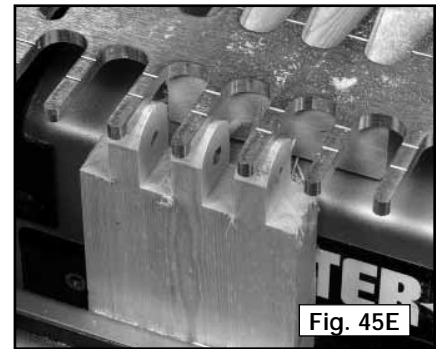
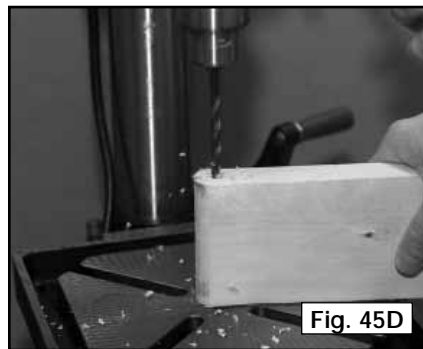
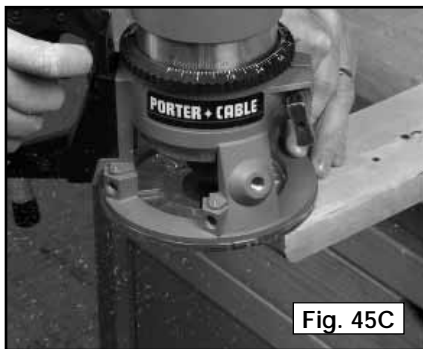

## 270° HINGES WITH A DRILLED HOLE

Follow the previous directions for 180° Hinge and use the following photos to help you make a hinge that will have 270° or more range of motion. Cut the boards as shown in Fig. 46A.

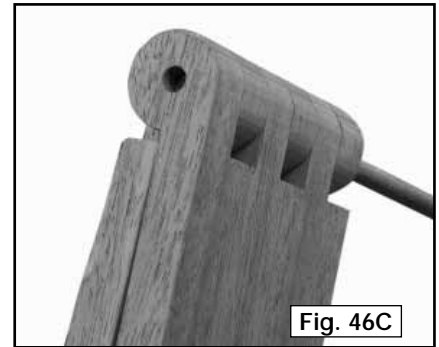
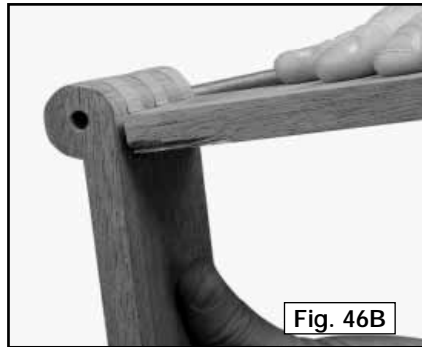
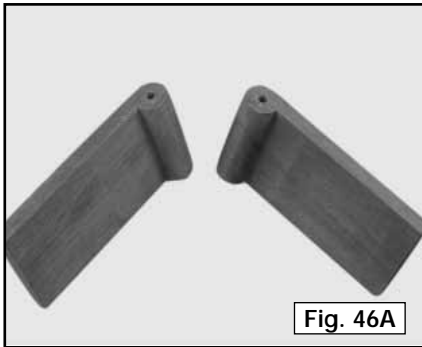

## 180° HINGES WITH ROUTER-MADE GROOVES

When the width of the workpieces are too wide for a drill bit to make the hole, use this method. Two boards compose each hinge half. Make a half-round dado at the end of the workpieces. When you glue the boards together, these two dados make the hole for the hinge pin.



- Step 1** - Use a router to make a half-round dado near the end of each of the four boards. Make the diameter of the groove equal to the diameter of the hinge pin, and the depth of cut half the diameter of the hinge pin (Fig. 48A).
- Step 2** - Insert the metal rod (long enough to stick out of both ends of the board) in one of the dados.
- Step 3** - Glue a second workpiece to the first (Fig. 48B).
- Step 4** - Repeat Steps two and three for the other half of the hinge.
- Step 5** - After the glue dries, remove the metal rod.
- Step 6** - Round over the ends of the glued boards.
- Step 7** - Make the rest of the hinge the same as you would with the 180° Hinge With a Drilled Hole.

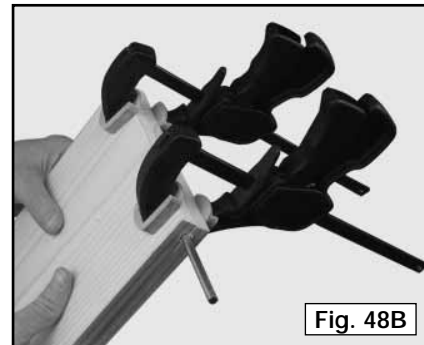
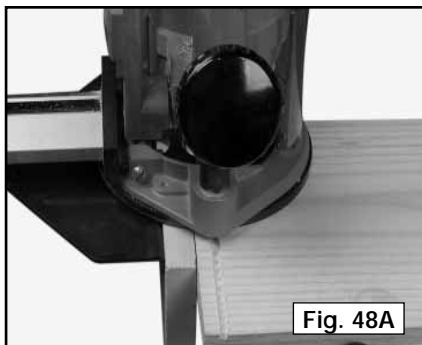

## 270° HINGES WITH ROUTER-MADE GROOVES

This method uses two pieces of wood glued together for each hinge-half. One of the pieces is very short.

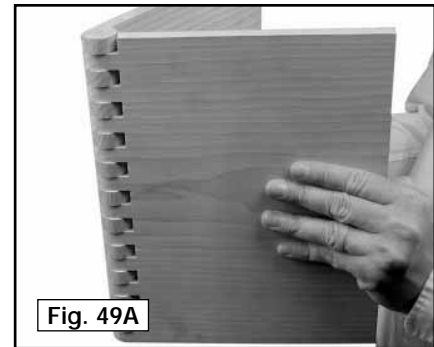

- Step 1** - Use a router to make a half-round dado near the end of a board. Make the diameter of the groove equal to the diameter of the hinge pin, and the depth of cut half the diameter of the hinge pin (Fig. 49B). Round over the ends of the boards (Fig. 49C).
- Step 2** - Cut off the ends of the boards. The length of the cut-off should be twice the thickness of the board (Fig. 49D).
- Step 3** - Repeat Step 1 for the remaining longer boards.
- Step 4** - For both hinge halves, glue the short board to the long board with the metal hinge rod in the grooves and sticking out both sides of the wood (Fig. 49E)
- Step 5** - After the glue dries, remove the metal rod.
- Step 6** - Make the rest of the hinge the same as you would with the 180° Hinge With a Drilled Hole.

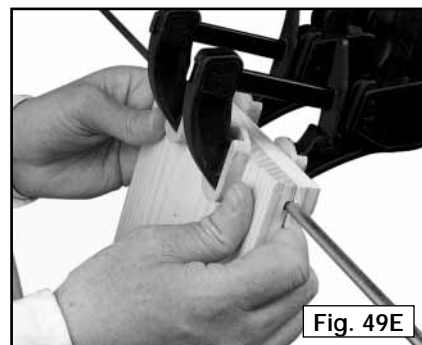
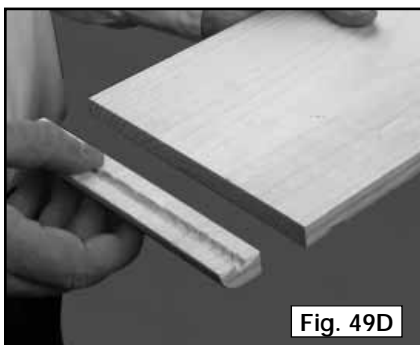
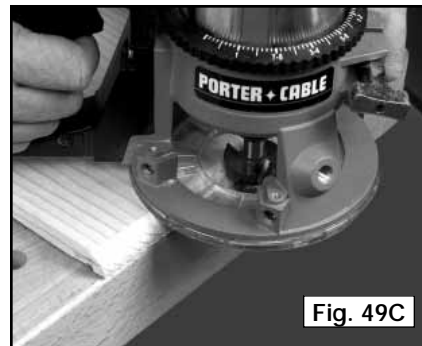
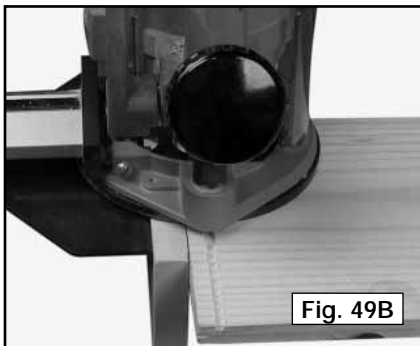

# ANGLED JOINTS

You can join boards at angles other than 90°. Four different methods are shown below by using the through dovetail procedure.

## OBTUSE ANGLED JOINTS

The simplest of these angled joints is the obtuse-angled dovetail. In this joint, two boards are joined together at an angle greater than 90°.

This joint can be made with either the template mounted to the base of the jig or to a clamping board. If the angle is 100° or greater, you must use the clamping board method.

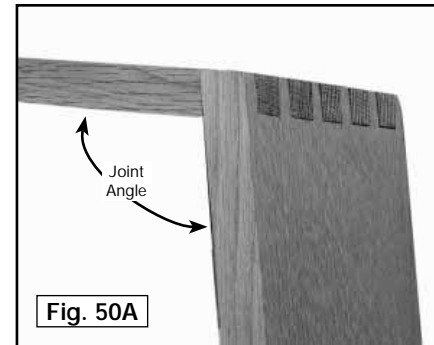

## SETUP WITH THE TEMPLATE MOUNTED TO THE BASE OF THE JIG

- Step 1** - Make an angled insert according to one of the drawings (Figs. 51A and 51B). Match the angle of the insert with the joint angle.
- Step 2** - Make sure that the 1/4-20 flat-head screw does not protrude (A) Fig. 51C.
- Step 3** - Remove the small front knobs, the front clamping rod, and the front clamping U channel. Leave the springs.
- Step 4** - Use two 1/2" 1/4-20 flat-head screws to secure the angled insert to the front of the base of the jig, with the thicker edge of the insert up. If you are using the 6" insert, install it in the 2 holes on the right (Fig. 51C).
- Step 5** - Replace the hardware that was removed in STEP 3.

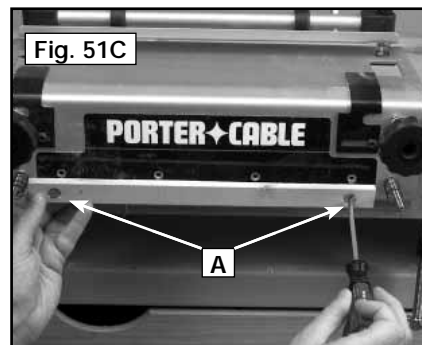
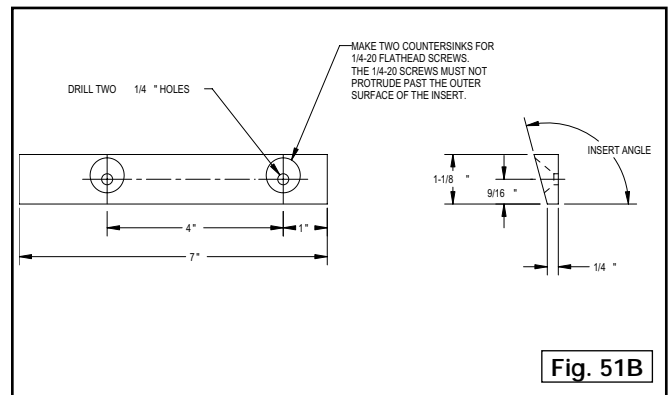
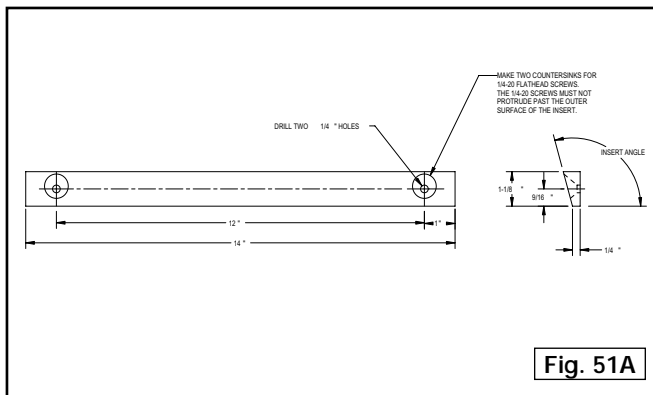

## SETUP WITH THE TEMPLATE MOUNTED TO A CLAMPING BOARD

- Step 1** - Make an angled clamping board according to the drawing (Fig. 52B). Match the angle of the clamping board to the joint angle.
- Step 2** - If necessary, create flat places on the clamping board parallel with the opposite side so that the clamps can grab.
- Step 3** - Attach the template to the clamping board with #10 wood screws. Position the angled surface on the side of the template with the straight fingers (Fig. 52A).

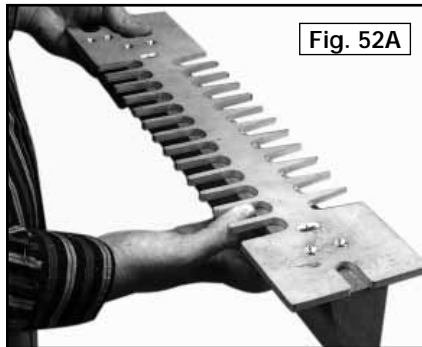

Fig. 52A

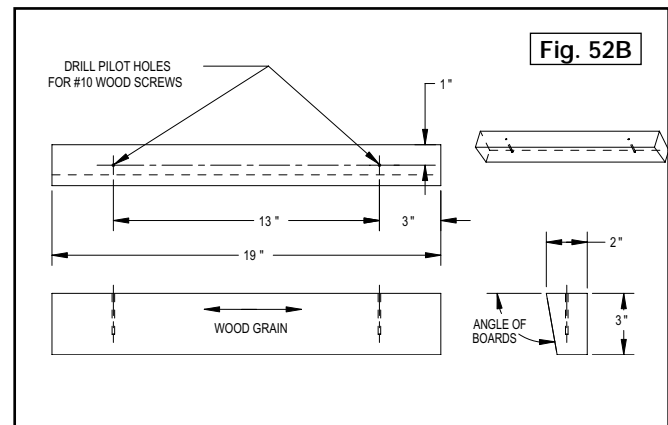

Fig. 52B

## CUTTING THE TAILS

- Step 1** - Cut the end of the tail board according to the instructions in the drawing (Fig. 53A). You can make these cuts on a table saw with the blade beveled (Fig. 53B). Set the miter gauge at 90° for the first cut, then use a tenoning jig for the second cut (Fig. 53C).
- Step 2** - If you use the template mounted to the base of the jig, mount the board with the outside face toward the base of the jig. Center the edges of the board between two fingers (Fig. 53D).
- Step 3** - If you use the board-mounted template, clamp the board with the outside face toward the angled surface of the clamping board. Center the board between two fingers.
- Step 4** - Align the template using the "tails" line.
- Step 5** - If the angle is steep, the "tails" line may not align with the wood. The joint will be fine if you place the straight portion of the template fingers directly over the tail board (A) Fig. 53E. Otherwise, you may have to use an angled clamping board.
- Step 6** - Set the router bit depth where the sides of the board are at a slight angle (Fig. 53F).
- Step 7** - Cut the tails and remove the tail board.

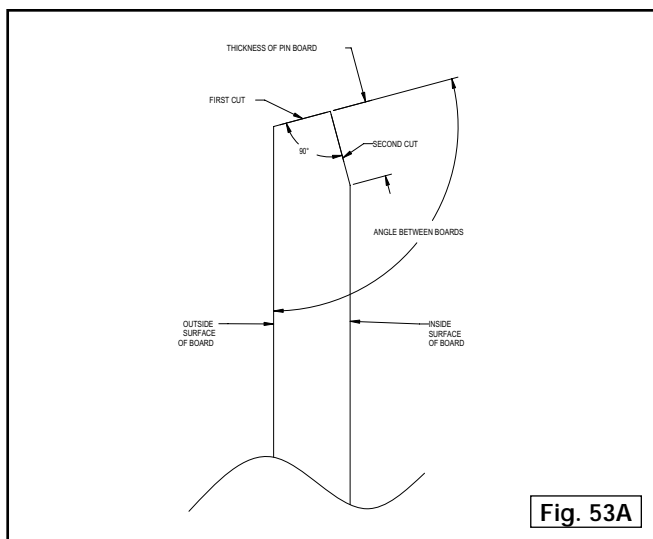

Fig. 53A

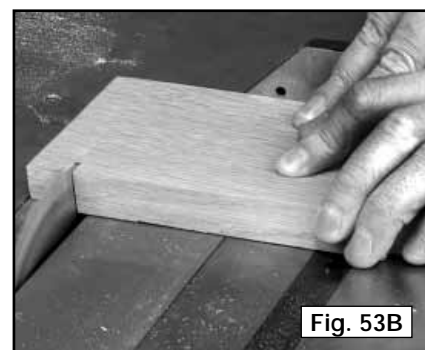

Fig. 53B

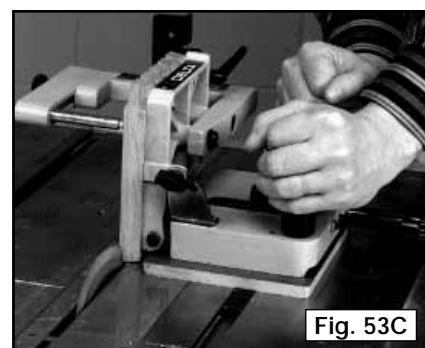

Fig. 53C

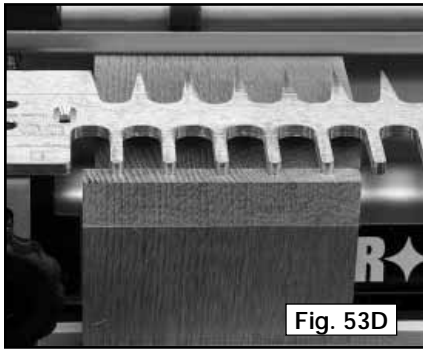

Fig. 53D



Fig. 53E

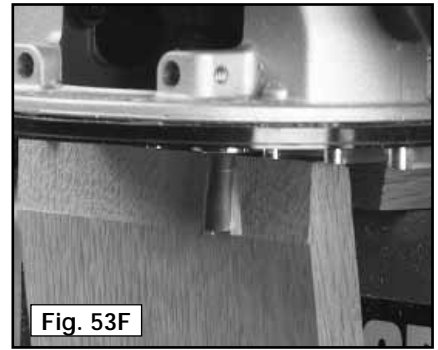

Fig. 53F

## CUTTING THE PINS

- Step 1** - Cut the end of the pin board according to the drawing (54A).
- Step 2** - If you use the template mounted to the base of the jig and a 12" angled insert, remove the small front knobs, clamping rod and clamping U channel. Then remove the angled insert and reinstall the hardware.
- Step 3** - Hold the boards together and mark the end of the pin board along the edges of the tails (Fig. 54B).
- Step 4** - Rotate the template so that the angled fingers are facing toward you.
- Step 5** - If you use the template mounted to the base of the jig, mount the pin board with the outside surface facing away from the base of the jig. Center the marks on the end of the board between the angled fingers of the template (Fig. 54C).
- Step 6** - If you use the template mounted on a clamping board, clamp the pin board with the outside surface facing away from the straight surface of the clamping board. Center the marks on the end of the board between the angled fingers of the template.
- Step 7** - Use the "PINS" line to align the template with the edge of the pin board.
- Step 8** - Set the router bit depth slightly more than the thickness of the tail board. Make sure that the bit does not contact the base of the jig.
- Step 9** - Cut the pins and remove the pin board.

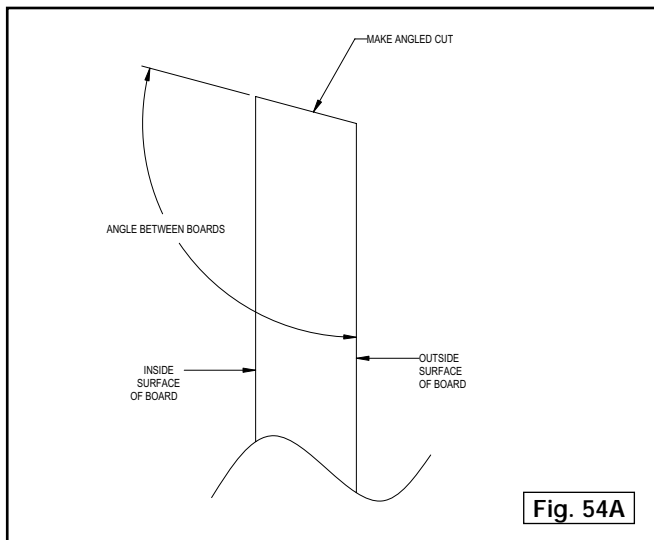

Fig. 54A

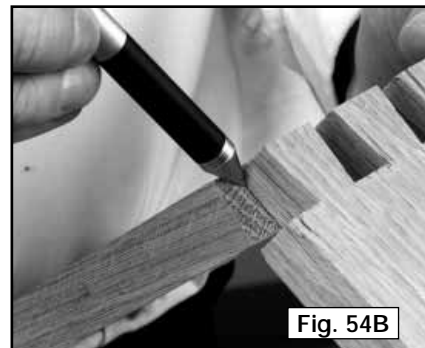

Fig. 54B

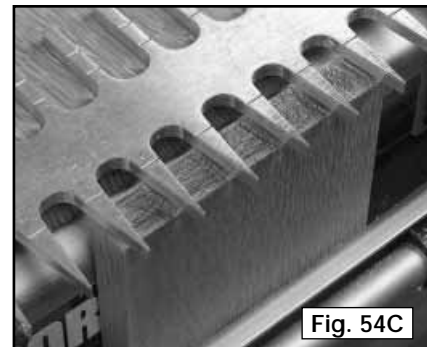

Fig. 54C

## FITTING THE JOINT

Fitting the joint is the same as fitting the standard dovetail. With the angled template fingers facing you, move the template toward you for a tighter joint or away for a looser joint.

# ACUTE ANGLED JOINTS

An acute angle joint joins two boards together at an angle less than 90°. The acute angled joint is very similar in construction to the obtuse angled joint and can be used with the obtuse angled joint to make boxes with angles other than 90°.

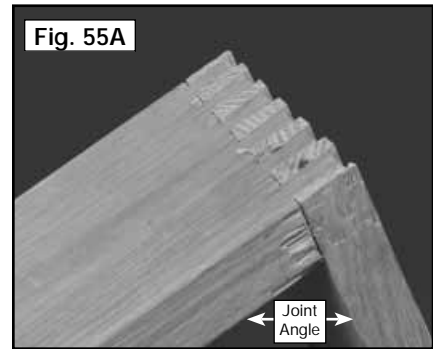

## SETUP

Use the same setup as you would for the obtuse angled joint. Use 180° minus the joint angle for the insert angle when you make your angled insert or your angled clamping board.

**NOTE:** If the acute angle and the obtuse angle add up to 180°, use the same setup for both joints.

## CUTTING THE TAILS

- Step 1** - Cut the end of the tail board according to the instructions on the drawing (Fig. 56A). Steep angles or thin wood will make for a weak joint. Make this cut on a table saw with the blade beveled. Set the miter gauge at 90° for the first cut and use a tenoning jig for the second cut (Fig. 56B).
- Step 2** - Clamp the workpiece as you did for the obtuse-angled joint, except face the outside surface of the board away from the base of the jig.
- Step 3** - Step 3 is identical to Step 5 in "CUTTING THE TAILS" of the obtuse-angled section.
- Step 4** - Set the router bit depth to where the step is in the tail board.
- Step 5** - Cut the tails and remove the tail board.

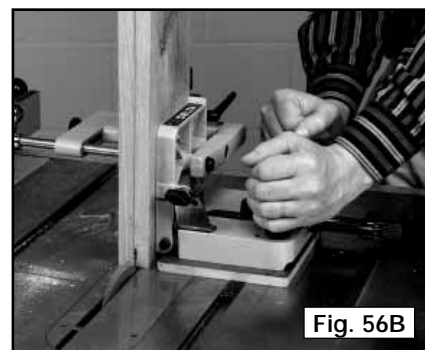
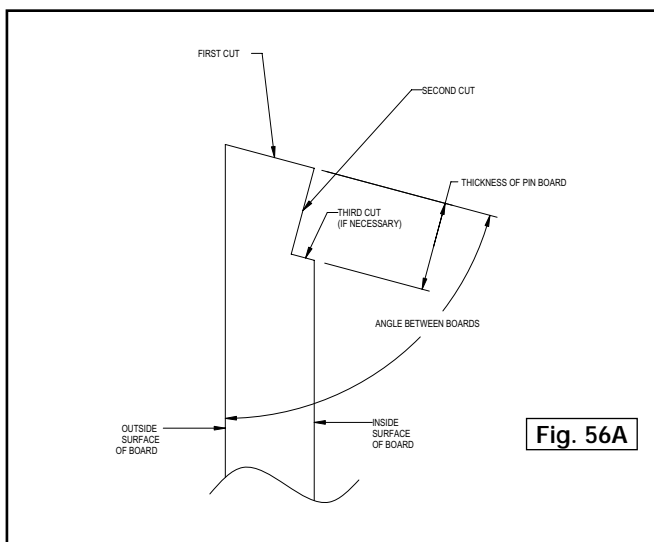

## CUTTING THE PINS

- Step 1** - Cut the end of the pin board according to the instructions on the drawing (Fig. 57A). Steep angles or thin wood will make for a weak joint. Make this cut on a table saw with the blade beveled, and with the miter gauge set at 90°.
- Step 2** - Clamp the workpiece as you did for the obtuse-angled joint.
- Step 3** - Hold the boards together and mark the end of the pin board at the edges of the tails.
- Step 4** - The remainder of the steps, including fitting the joint, are identical to the obtuse-angled joint section.



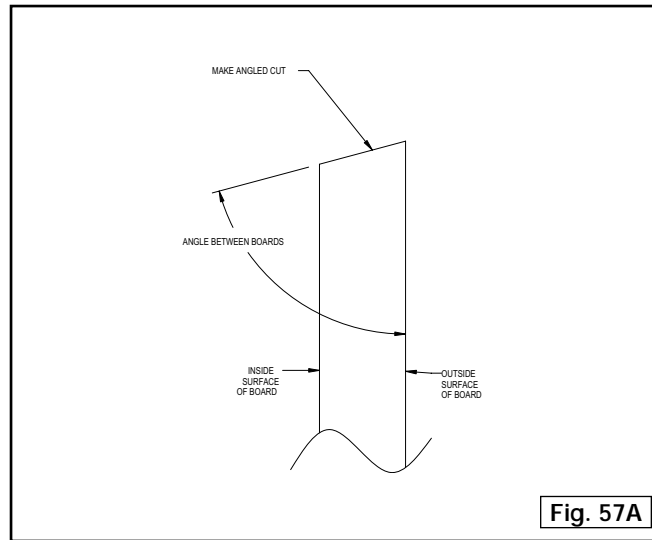

## SLANTED-SIDE JOINTS

Two boards joined at 90°, with one board slanted to the side is known as a slanted-side joint. This method is used to make a box with the ends at right angles to the table, but with the sides tilted outward (cradles, planters, magazine racks).

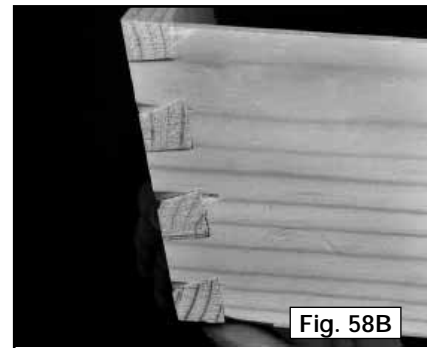
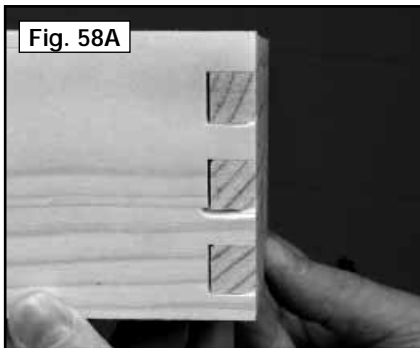

**NOTE:** Usually, the tails are cut into the ends and the pins are cut into the sides.

## CUTTING THE TAILS

**Step 1** - Cut the ends of the tail board at the desired angle. Note that when the angle is approaching 15° that the tails weaken (Fig. 59A).

**Step 2** - Mount the board so that the outside surface faces the base of the jig and the edge is against the template (Fig. 59B).

**Step 3** - Cut the tails in the same manner as you would the standard dovetails.

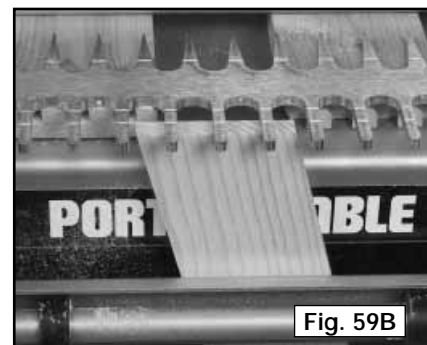
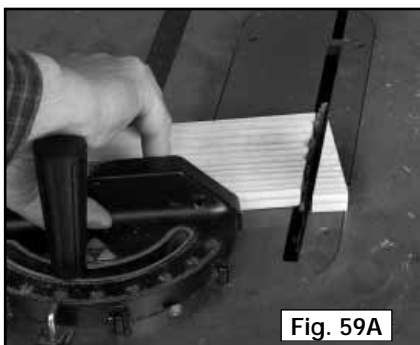

## CUTTING THE PINS

- Step 1** - Cut the pin board according to Fig. 60A.
- Step 2** - Hold the boards together and mark the pin board at the edges of the tails (Fig. 60B).
- Step 3** - Rotate the template so that the tapered fingers for cutting the pins is facing you.
- Step 4** - Mount the pin board with the outside surface facing away from the base of the jig. Center the marks from STEP 2 between the tapered fingers (A) Fig. 60C.
- Step 5** - Cut the pins in the same manner as you would with standard dovetails.

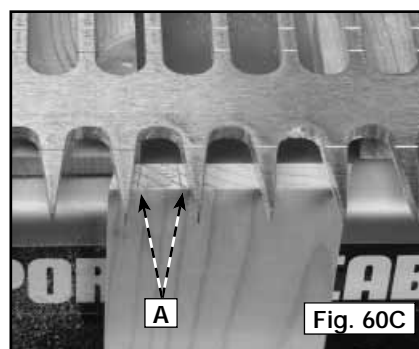
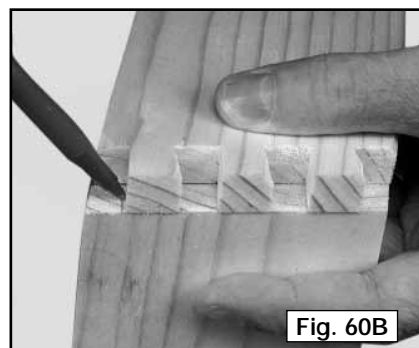
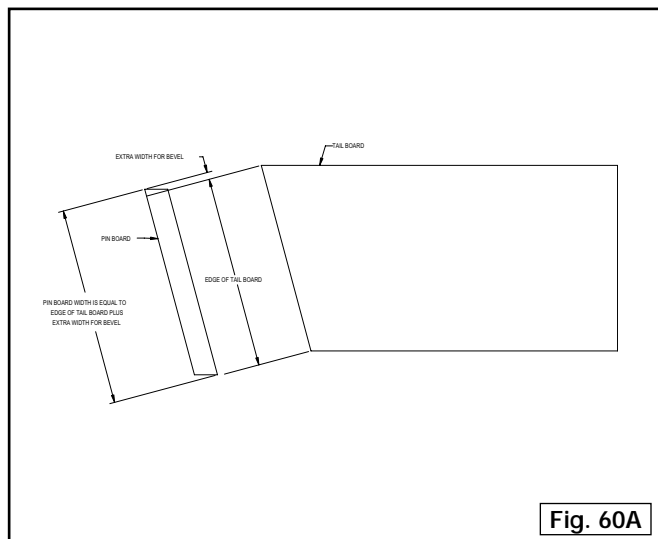

## FITTING THE JOINT

Fitting the joint is the same as fitting the standard dovetail. HINT: Use pieces of scrap wood the same thickness and species of wood to make test pin boards until the template is adjusted for a perfect fit.

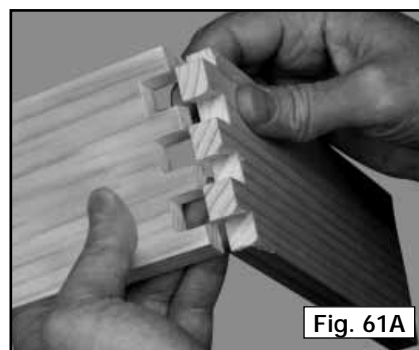

---

---

## COMPOUND-ANGLE JOINTS

Two boards joined at 90°, with both boards slanted to the side is known as a compound-angle joint. This method is used to make serving trays or planters.

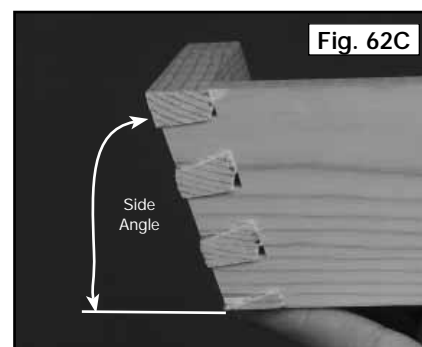
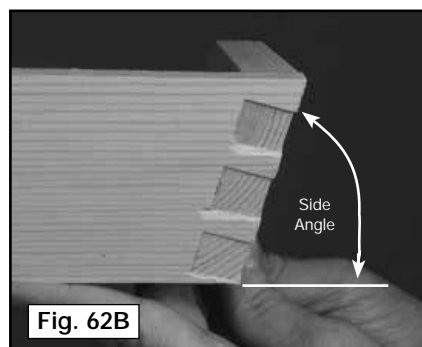

**NOTE:** The instructions given here are for templates mounted to the base of the jig. However, this joint can also be made with templates mounted to angled clamping boards. You must use the angled clamping board for steeper angles.

Use the following table for setting up your table saw for these cuts:

DESIRED SIDE ANGLE	MITER gauge ANGLE	BLADE TILT ANGLE
85°	85.0°	89.6°
80°	80.1°	88.3°
75°	75.5°	86.2°
70°	71.1°	83.3°
65°	67.1°	79.7°

## SETUP

Use the same setup as you would for the obtuse angled joint. Use the blade tilt angle for making the angle insert or the angled clamping block. Bevel the edges according to the drawing (Fig. 63A).

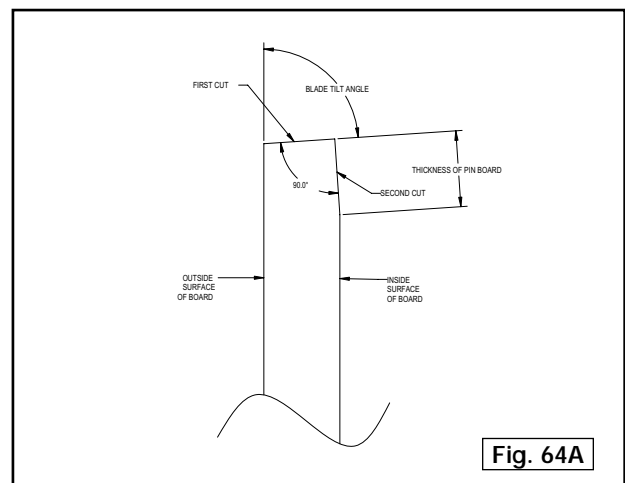
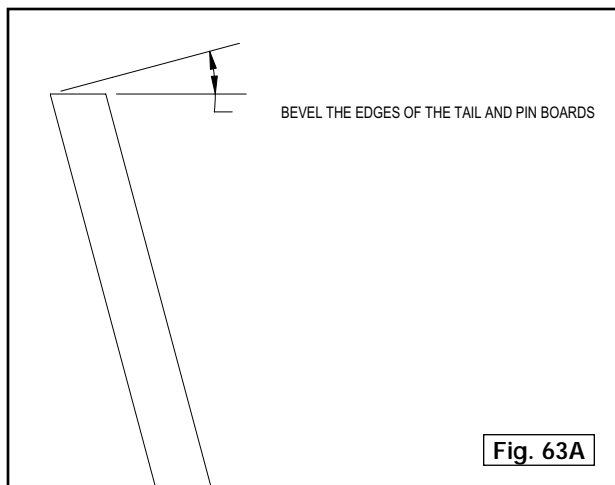

**Step 1 -** Cut the end of the tail board according to the drawing (Fig. 64A). Set the miter gauge and tilt the blade to the values in the above table. Make the first cut with the board flat on the table surface and guide it with the miter gauge (Fig. 64B). Make the second cut with a tenoning jig (Fig. 64C).

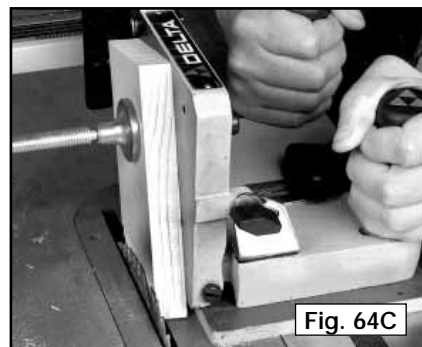
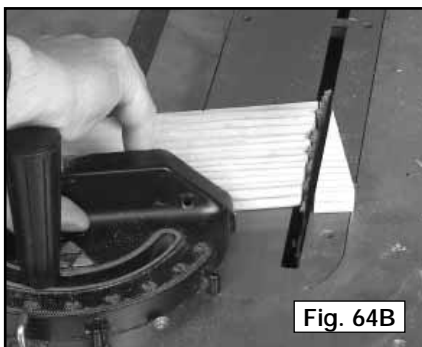

## CUTTING THE TAILS

- Step 2** - With the angled insert attached to the base of the jig, mount the tail board with the outside surface of the board facing the jig and with the board centered between the fingers of the template (Fig. 64D).
- Step 3** - Align the template using the "Tails" alignment line. If the angle is so steep that the "Tails" alignment line will not work, you may have to use an angled clamping board. However, as long as the rounded part of the fingers go past the edge of the wood, the set up will work fine as is.
- Step 4** - Set the router bit depth to where the sides of the board go off at a slight angle (Fig. 64E).
- Step 5** - Cut the tails and remove the tail board.

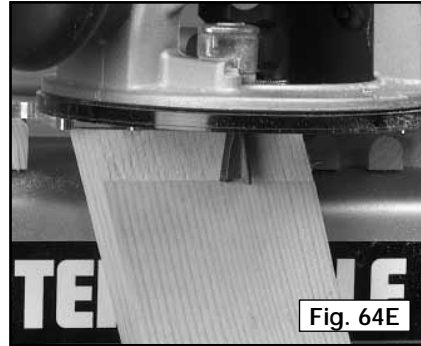
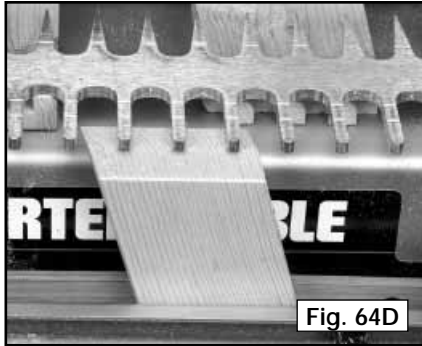

## CUTTING THE PINS

- Step 1** - Cut the end of the tail board according to the drawing (Fig. 65A). Set the miter gauge and tilt the blade to the values in the previous table. Remember that the miter gauge for the tailboard must be tilted opposite for the pin board.
- Step 2** - If you are using the 12" long angled insert, remove it from the jig.
- Step 3** - Hold the outside surfaces of the boards together and mark the pin board at the edges of the tail (Fig. 65B).
- Step 4** - 65B).
- Step 5** - Rotate the template so that the angled fingers for cutting the pins is facing you. Mount the pin board with the outside surface facing away from the base of the jig. Center the marks on the end of the board between the angled fingers of the template (A) Fig. 65C.
- Step 6** - the end of the board between the angled fingers of the template (A) Fig. 65C.
- Step 7** - Use the "PINS" alignment line to align the template with the edge of the pin board. Set the router bit depth to slightly more than the thickness of the tail board, but prevent the bit from contacting the base of the jig..
- Step 8** - Cut the pins and remove the pin board.

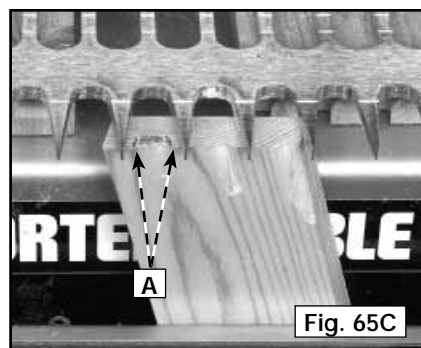
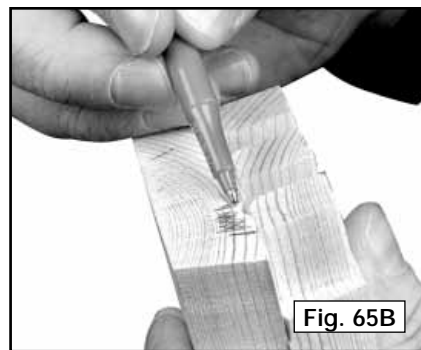
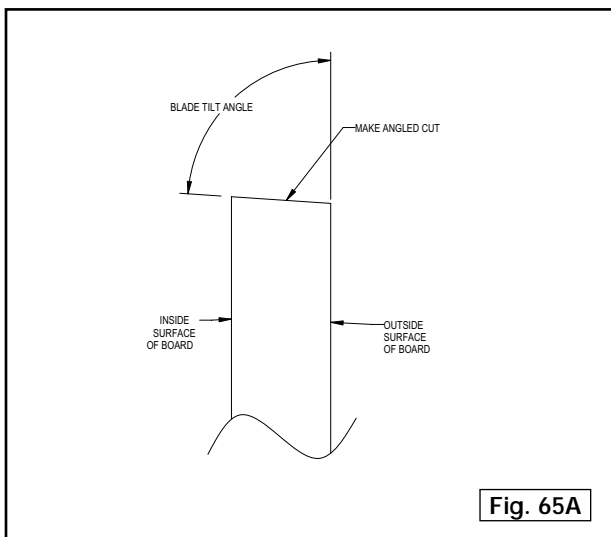

## FITTING THE JOINT

Fitting the joint is the same as fitting the standard dovetail. HINT: Use pieces of scrap wood the same thickness and species of wood to make test pin boards until the template is adjusted for a perfect fit.

---

---

## INLAYED JOINTS

The 4200 series dovetail jigs will allow you to make joints with inlays of different colored wood for a very unique

### INLAYED THROUGH DOVETAIL

The inlayed through dovetail is produced by utilizing 2 through dovetails, one on top of the other.

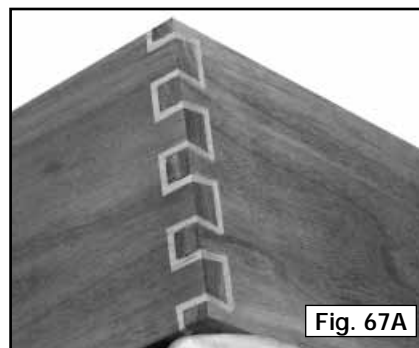

### SETUP

Select two sets of router bit combinations from the table for "Through Dovetail Router Bit Combinations" in the section "**TABLES OF COMMONLY AVAILABLE ROUTER BIT SIZES**". Use the following table to determine the thickness of the inlay line

Router Bit Set Combinations	Thickness of Inlay Line in Decimal Measurements	Approximate Thickness in Fractional Measurements
T1 & T2	0.056	7/128
T1 & T3	0.083	11/128
T1 & T4	0.097	3/32
T2 & T3	0.028	1/32
T2 & T4	0.042	5/128
T3 & T4	0.014	1/64

Use the set with the bigger dovetail bit for the first joint. Make sure that the length of the cutter on the bit is at least the thickness of the pin board plus the thickness of the inlay line. At the same time, make sure that the length of the cutter on the straight bit is at least the thickness of the tail board.

Use the set with the smaller dovetail bit for the second joint. Make sure that the length of the cutter is at least the thickness of the pin board. At the same time, make sure that the length of the cutter on the straight bit is at least the thickness of the tail board plus the thickness of the inlay line.

Plane the inlay board the same thickness as the thickness of the pin board plus the thickness of the inlay line from the table above.

### MAKE THE FIRST JOINT

Make the first joint the same way that you would make a standard through dovetail (Fig. 68A).

If the jig is set up to make through dovetails with the tails and pins slightly protruding or recessed, use the alternate method of setting the router bit depth found in the section on "MISCELLANEOUS TECHNIQUES".

Glue the joint together and let it dry.

## CUT OFF THE INLAY BOARD

After the joint has dried, cut the inlay board to an amount equal to the thickness of the inlay (Fig. 68B).

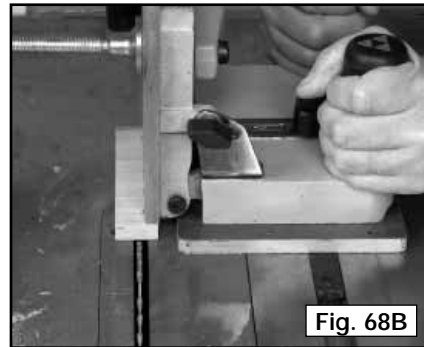
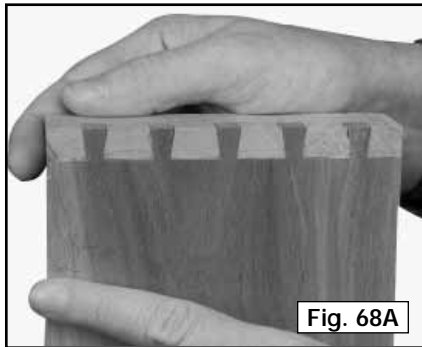

If desired, you can cut off the small area shown from the remainder of the inlay wood (Fig. 68C). If left on, the completed joint will have an extra amount of material on the inside. another alternative is to bevel this extra material (Fig. 68D).

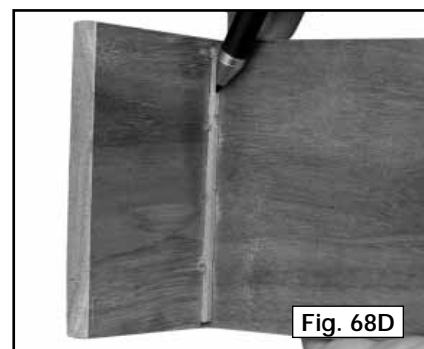
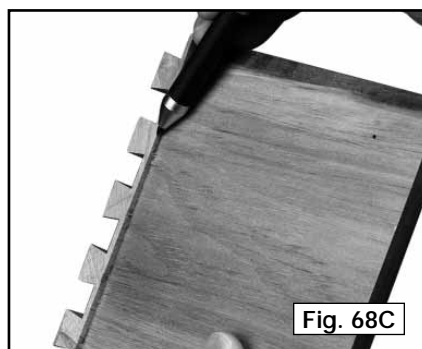

## MAKE THE SECOND JOINT

Make the second joint the same way as you would a standard through dovetail. HINT: Do not move the offset guides after making the first joint.

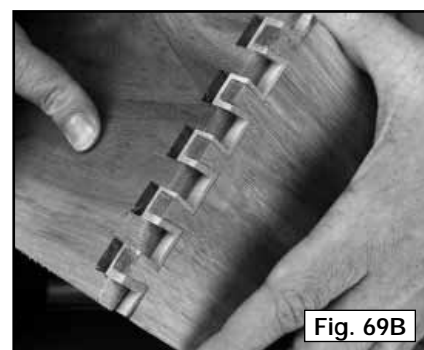
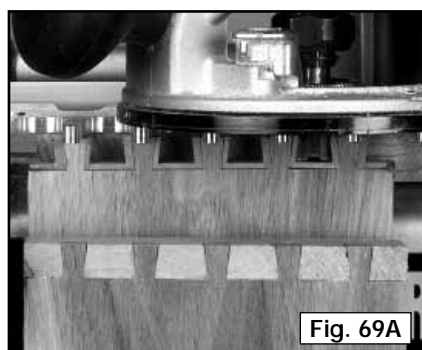

---

---

## INLAYED HALF-BLIND DOVETAIL

Make this joint by producing two half-blind dovetails on top of each other.

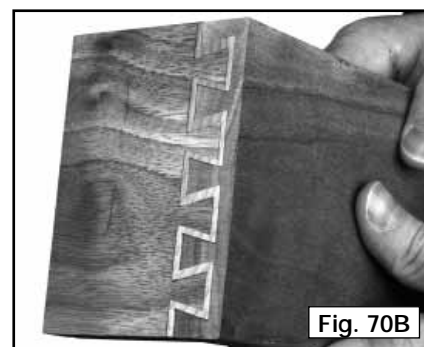

## SETUP

Select one set of dovetail bits from the table for Combinations for Half-blind dovetails with the pins and the tails cut separately in the section "**TABLES OF COMMONLY AVAILABLE ROUTER BIT SIZES**". Use the following table to determine the thickness of the inlay line:

Dovetail Bit Set	Thickness of Inlay Line in Decimal Measurements	Approximate Thickness in Fractional Measurements
H1	0.100	13/128
H2	0.050	3/64
H3	0.042	5/128
H4	0.028	1/32
H5	0.014	1/64

NOTE: If the thickness of the inlay line is very thin, you may have difficulty cutting the inlay correctly.

## MAKE THE FIRST JOINT

The first joint is identical to that described in the section on Half-Blind Dovetail Bits with the Pins and Tails Cut Separately under the chapter "ALTERNATE ROUTER BITS". Use the inlay material as the pin board (normally the drawer front). For the first joint, cut the tail board with the larger dovetail bit and the pin board with the smaller dovetail bit.

Glue the joint and let it dry.

## CUT OFF THE INLAY BOARD

After the joint has dried, cut off the inlay board. Cut off the pin board flush with the inside edge of the tail board (Fig. 71B). Then cut off the front edge of the inlay board (Fig. 71C), making sure that the remainder of the inlay (A) Fig 71D is cut so that the thickness is equal to the thickness found in the table on the previous page.

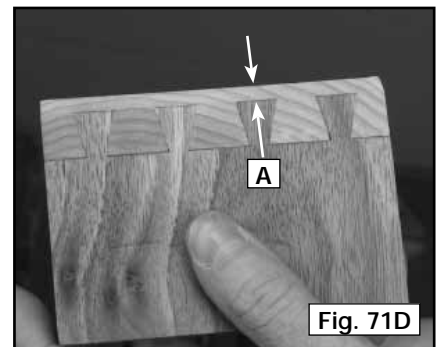
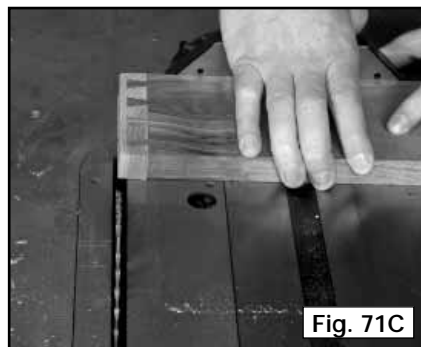
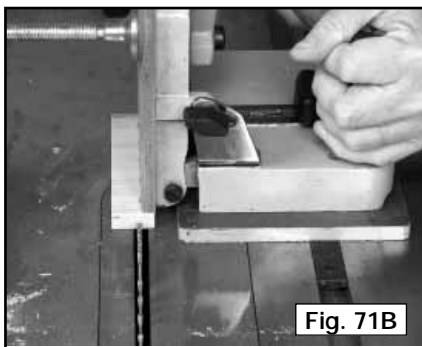
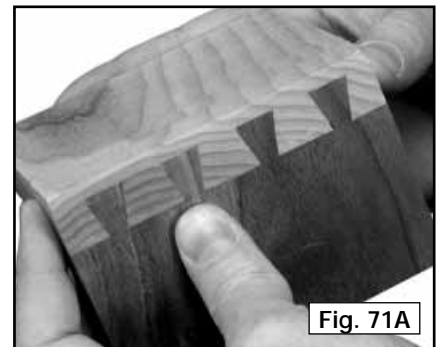

## MAKE THE SECOND JOINT

The second joint is also identical to that described in the section on Half-Blind Dovetail Bits with the Pins and Tails Cut Separately under the chapter "ALTERNATE ROUTER BITS". Use the board from the previous section as the tail board. Cut the tail board with the smaller dovetail bit and the pin board with the larger dovetail bit.

HINT: Using two routers to make these joints will make your work easier.

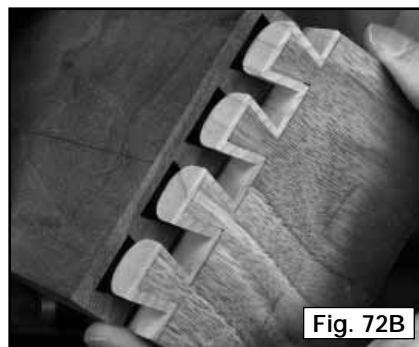
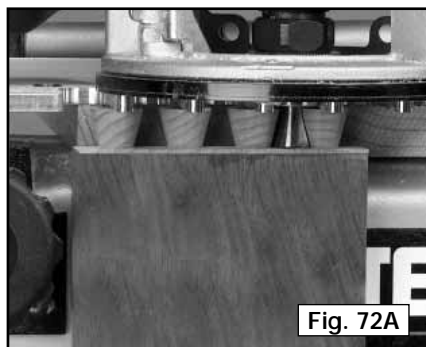

---

---

## INLAYED BOX JOINT

This joint is made by cutting two box joints on top of each other.

### SETUP

Select one set of dovetail bits from the table for "Box Joint Bit Combinations" in the section "TABLES OF COMMONLY AVAILABLE ROUTER BIT SIZES". Use the following table to determine the thickness of the inlay line:

Straight Bit Set	Thickness of Inlay Line
B2	1/16"
B3	1/8"

NOTE: If the thickness of the inlay line is very thin, you may have difficulty in cutting the inlay correctly. You must plane the inlay board to the thickness of the second board plus the thickness of the inlay line.

### MAKE THE FIRST JOINT

The first joint is identical to a box joint with alternate router bit sizes as found in the section "ALTERNATE ROUTER BITS". Make a box joint with the first board and the inlay board. Use the larger straight bit with the first board and the smaller bit with the inlay board.

If the jig is set up to make through dovetails with the tails and pins slightly protruding or recessed, use the alternate method of setting the router bit depth found in the section on "MISCELLANEOUS TECHNIQUES".

NOTE: For the tails and pins to be flush, be careful to make the bit depth very precise.

### CUT OFF THE INLAY BOARD

After the joint has dried, cut off most of the inlay board. Leave an amount equal to the thickness of the inlay.

### MAKE THE SECOND JOINT

The second joint is also identical to a box joint with alternate router bit sizes as found in the section "ALTERNATE ROUTER BITS". Make a box joint with the board from the previous section and the second board. Use the smaller straight bit with the board from the previous section and the larger bit with the second board.

HINT: this section of your project (aligning the joint) is easier if you do not move the offset guides after making the first joint.



## TABLES OF COMMONLY AVAILABLE ROUTER BIT SIZES

<b>THROUGH DOVETAIL ROUTER BIT COMBINATIONS</b>		
Combination Number	7° Dovetail Bit	Straight Bit
T1	3/4"	3/16"
T2	5/8"	5/16"
T3	9/16"	3/8"
T4	17/32"	13/32"

<b>HALF-BLIND DOVETAIL BITS</b>		
Bit (Diameter and Angle)		Approximate* Depth of Cut
17/32"	7°	13/32"
17/32"	14°	3/16"
9/16"	7°	3/4"
5/8"	14°	9/16"

<b>COMBINATIONS FOR HALF-BLIND DOVETAILS WITH THE PINS AND THE TAILS CUT SEPARATELY.</b>					
<u>Combination Number</u>	<u>Large Dovetail Bit (Diameter and Angle)</u>		<u>Small Dovetail Bit (Diameter and Angle)</u>		<u>Approximate* Depth of Cut</u>
H1	3/4"	14°	1/2"	14°	9/16"
H2	5/8"	14°	1/2"	14°	3/8"
H3	5/8"	7°	17/32"	7°	7/8"
H4	5/8"	7°	9/16"	7°	1"
H5	9/16"	7°	17/32"	7°	5/8"

★ The actual depth-of-cut may be a little deeper or shallower than what appears on this table. Since vendors use different manufacturing tolerances on bit dimensions, use the manufacturer's advertised bit dimensions only as a guide. Remember that a small amount of variation within tolerances can have a large impact on the final depth-of-cut.

<b>BOX JOINT BIT COMBINATIONS</b>		
Combination Number	Larger Straight Bit	Smaller Straight Bit
B1	1/2"	1/2"
B2	9/16"	7/16"
B3	5/8"	3/8"

## TROUBLESHOOTING

For assistance with your tool, visit our website at [www.porter-cable.com](http://www.porter-cable.com) for a list of service centers, or call the Porter-Cable Customer Care Center at (888) 848-5175.

## MAINTENANCE

**▲WARNING:** To reduce the risk of serious personal injury, turn tool off and disconnect tool from power source before installing and removing accessories, before adjusting or changing set-ups or when making repairs. An accidental start-up can cause injury.

### REPAIRS

For assistance with your tool, visit our website at [www.porter-cable.com](http://www.porter-cable.com) for a list of service centers, or call the Porter-Cable Customer Care Center at (888) 848-5175.

### CLEANING

**▲WARNING:** Periodically blowing dust and chips out of the motor housing using clean, dry compressed air is a suggested maintenance procedure. To reduce the risk of serious personal injury, **ALWAYS** wear ANSI Z87.1 safety glasses while using compressed air.

**▲WARNING:** When cleaning, use only mild soap and a damp cloth on plastic parts. Many household cleaners contain chemicals which could seriously damage plastic. Also, do not use gasoline, turpentine, lacquer or paint thinner, dry cleaning fluids or similar products which may seriously damage plastic parts. **NEVER** let any liquid get inside the tool; **NEVER** immerse any part of the tool into a liquid.

## SERVICE

### REPLACEMENT PARTS

Use only identical replacement parts. For a parts list or to order parts, visit our website at [servicenet.porter-cable.com](http://servicenet.porter-cable.com). You can also order parts from your nearest Porter-Cable Factory Service Center or Porter-Cable Authorized Warranty Service Center. Or, you can call our Customer Care Center at (888) 848-5175.

### SERVICE AND REPAIRS

All quality tools will eventually require servicing and/or replacement of parts. For information about Porter-Cable, its factory service centers or authorized warranty service centers, visit our website at [www.porter-cable.com](http://www.porter-cable.com) or call our Customer Care Center at (888) 848-5175. All repairs made by our service centers are fully guaranteed against defective material and workmanship. We cannot guarantee repairs made or attempted by others.

You can also write to us for information at PORTER-CABLE, 4825 Highway 45 North, Jackson, Tennessee 38305 - Attention: Product Service. Be sure to include all of the information shown on the nameplate of your tool (model number, type, serial number, etc.).

## ACCESSORIES

A complete line of accessories is available from your Porter-Cable Factory Service Center or a Porter-Cable Authorized Warranty Service Center. Please visit our Web Site [www.porter-cable.com](http://www.porter-cable.com) for a catalog or for the name of your nearest supplier.

**▲WARNING:** Since accessories other than those offered by Porter-Cable have not been tested with this product, use of such accessories could be hazardous. For safest operation, only Porter-Cable recommended accessories should be used with this product.

# WARRANTY

## PORTER-CABLE LIMITED ONE YEAR WARRANTY

Porter-Cable warrants its Professional Power Tools for a period of one year from the date of original purchase. We will repair or replace at our option, any part or parts of the product and accessories covered under this warranty which, after examination, proves to be defective in workmanship or material during the warranty period. For repair or replacement return the complete tool or accessory, transportation prepaid, to your nearest Porter-Cable Service Center or Authorized Service Station. Proof of purchase may be required. This warranty does not apply to repair or replacement required due to misuse, abuse, normal wear and tear or repairs attempted or made by other than our Service Centers or Authorized Service Stations.

ANY IMPLIED WARRANTY, INCLUDING THE IMPLIED WARRANTIES OF MERCHANTABILITY AND FITNESS FOR A PARTICULAR PURPOSE, WILL LAST ONLY FOR ONE (1) YEAR FROM THE DATE OF PURCHASE.

To obtain information on warranty performance please write to: PORTER-CABLE CORPORATION, 4825 Highway 45 North, Jackson, Tennessee 38305; Attention: Product Service. THE FOREGOING OBLIGATION IS PORTER-CABLE'S SOLE LIABILITY UNDER THIS OR ANY IMPLIED WARRANTY AND UNDER NO CIRCUMSTANCES SHALL PORTER-CABLE BE LIABLE FOR ANY INCIDENTAL OR CONSEQUENTIAL DAMAGES. Some states do not allow limitations on how long an implied warranty lasts or the exclusion or limitation of incidental or consequential damages, so the above limitation or exclusion may not apply to you.

This warranty gives you specific legal rights and you may also have other legal rights which vary from state to state.

**LATIN AMERICA:** This warranty does not apply to products sold in Latin America. For products sold in Latin America, see country specific warranty information contained in the packaging, call the local company or see website for warranty information.

The following are trademarks for one or more Porter-Cable and Delta products: • Les marques suivantes sont des marques de commerce se rapportant à un ou plusieurs produits Porter-Cable ou Delta : • Las siguientes son marcas comerciales para uno o más productos de Porter-Cable y Delta:

2 BY 4<sup>®</sup>, 890<sup>™</sup>, Air America<sup>®</sup>, AIRBOSS<sup>™</sup>, Auto-Set<sup>®</sup>, B.O.S.S.<sup>®</sup>, Bammer<sup>®</sup>, Biesemeyer<sup>®</sup>, Builders Saw<sup>®</sup>, Charge Air<sup>®</sup>, Charge Air Pro<sup>®</sup>, CONTRACTOR SUPERDUTY<sup>®</sup>, Contractor's Saw<sup>®</sup>, Delta<sup>®</sup>, DELTA<sup>®</sup>, Delta Industrial<sup>®</sup>, DELTA MACHINERY & DESIGN<sup>™</sup>, Delta Shopmaster and Design<sup>®</sup>, Delta X5<sup>®</sup>, Deltacraft<sup>®</sup>, DELTAGRAM<sup>®</sup>, Do It. Feel It.<sup>®</sup>, DUAL LASERLOC AND DESIGN<sup>®</sup>, EASY AIR<sup>®</sup>, EASY AIR TO GO<sup>™</sup>, ENDURADIAMOND<sup>®</sup>, Ex-Cell<sup>®</sup>, Front Bevel Lock<sup>®</sup>, Get Yours While the Sun Shines<sup>®</sup>, Grip to Fit<sup>®</sup>, GRIPVAC<sup>™</sup>, GTF<sup>®</sup>, HICKORY WOODWORKING<sup>®</sup>, Homecraft<sup>®</sup>, HP FRAMER HIGH PRESSURE<sup>®</sup>, IMPACT SERIES<sup>™</sup>, Innovation That Works<sup>®</sup>, Jet-Lock<sup>®</sup>, Job Boss<sup>®</sup>, Kickstand<sup>®</sup>, LASERLOC<sup>®</sup>, LONG-LASTING WORK LIFE<sup>®</sup>, MAX FORCE<sup>™</sup>, MAX LIFE<sup>®</sup>, Micro-Set<sup>®</sup>, Midi-Lathe<sup>®</sup>, Monsoon<sup>®</sup>, MONSTER-CARBIDE<sup>™</sup>, Network<sup>®</sup>, OLDHAM<sup>®</sup>, Omnijig<sup>®</sup>, PC EDGE<sup>®</sup>, Performance Crew<sup>™</sup>, Performance Gear<sup>®</sup>, Pocket Cutter<sup>®</sup>, Porta-Band<sup>®</sup>, Porta-Plane<sup>®</sup>, Porter Cable<sup>®</sup>, Porter-Cable Professional Power Tools<sup>®</sup>, Powerback<sup>®</sup>, POZI-STOP<sup>™</sup>, Pressure Wave<sup>®</sup>, PRO 4000<sup>®</sup>, Proair<sup>®</sup>, Quicksand and Design<sup>®</sup>, Quickset II<sup>®</sup>, QUIET DRIVE TECHNOLOGY<sup>™</sup>, QUIET DRIVE TECHNOLOGY AND DESIGN<sup>™</sup>, Quik-Change<sup>®</sup>, QUIK-TILT<sup>®</sup>, RAPID-RELEASE<sup>™</sup>, RAZOR<sup>®</sup>, Redefining Performance<sup>®</sup>, Riptide<sup>®</sup>, Safe Guard II<sup>®</sup>, Sand Trap and Design<sup>®</sup>, Sanding Center<sup>®</sup>, Saw Boss<sup>®</sup>, Shop Boss<sup>®</sup>, Sidekick<sup>®</sup>, Site Boss<sup>®</sup>, Speed-Bloc<sup>®</sup>, Speedmatic<sup>®</sup>, Stair Ease<sup>®</sup>, Steel Driver Series<sup>®</sup>, SUPERDUTY<sup>®</sup>, T4 & DESIGN<sup>®</sup>, THE AMERICAN WOODSHOP<sup>®</sup>, THE PROFESSIONAL EDGE<sup>®</sup>, Thin-Line<sup>®</sup>, Tiger Saw<sup>®</sup>, TIGERCLAW<sup>®</sup>, TIGERCLAW AND DESIGN<sup>®</sup>, Torq-Buster<sup>®</sup>, TRU-MATCH<sup>®</sup>, T-Square<sup>®</sup>, Twinlaser<sup>®</sup>, Unifence<sup>®</sup>, Uniguard<sup>®</sup>, UNIRIP<sup>®</sup>, UNISAW<sup>®</sup>, UNITED STATES SAW<sup>®</sup>, Veri-Set<sup>®</sup>, Versa-Feeder<sup>®</sup>, VIPER<sup>®</sup>, VT<sup>™</sup>, VT RAZOR<sup>™</sup>, Water Driver<sup>®</sup>, WATER VROOM<sup>®</sup>, Waveform<sup>®</sup>, Whisper Series<sup>®</sup>, X5<sup>®</sup>, YOUR ACHIEVEMENT. OUR TOOLS.<sup>®</sup>

Trademarks noted with ® are registered in the United States Patent and Trademark Office and may also be registered in other countries. Other trademarks may apply. • Les marques de commerce suivies du symbole ® sont enregistrées auprès du United States Patent and Trademark Office et peuvent être enregistrées dans d'autres pays. D'autres marques de commerce peuvent également être applicables. • Las marcas comerciales con el símbolo ® están registradas en la Oficina de patentes y marcas comerciales de Estados Unidos (United States Patent and Trademark Office), y también pueden estar registradas en otros países. Posiblemente se apliquen otras marcas comerciales registradas.

**PORTER  CABLE<sup>®</sup>**

Porter-Cable  
4825 Highway 45 North  
Jackson, TN 38305  
(800) 848-5175  
[www.deltaportercable.com](http://www.deltaportercable.com)