

Instruction manual

Double Insulated Portable Electric Screwdrivers

MODELS 4630 and 4634
Depth Sensing Drywall and Deck Drivers



MODEL 4640
Depth Sensing Fastener Driver

To learn more about Porter-Cable
visit our website at:

<http://www.porter-cable.com>

PORTER-CABLE
PROFESSIONAL POWER TOOLS

IMPORTANT

Please make certain that the person who is to use this equipment carefully reads and understands these instructions before starting operations.

The Model and Serial No. plate is located on the main housing of the tool. Record these numbers in the spaces below and retain for future reference.

Model No. _____

Type _____

Serial No. _____

TABLE OF CONTENTS

IMPORTANT SAFETY INSTRUCTIONS	2
SAFETY GUIDELINES	3
GENERAL SAFETY RULES	4
ADDITIONAL SPECIFIC SAFETY RULES	6
CARTON CONTENTS	8
FUNCTIONAL DESCRIPTION	8
ASSEMBLY	8
OPERATION	8
TROUBLESHOOTING	11
MAINTENANCE	11
SERVICE	13
ACCESSORIES	13
WARRANTY	14
ESPAÑOL	15
FRANÇAISE	27
SERVICE CENTER LOCATIONSback cover

IMPORTANT SAFETY INSTRUCTIONS

▲ WARNING Read and understand all warnings and operating instructions before using any tool or equipment. When using tools or equipment, basic safety precautions should always be followed to reduce the risk of personal injury. Improper operation, maintenance or modification of tools or equipment could result in serious injury and property damage. There are certain applications for which tools and equipment are designed. Porter-Cable strongly recommends that this product NOT be modified and/or used for any application other than for which it was designed.

If you have any questions relative to its application DO NOT use the product until you have written Porter-Cable and we have advised you.

Online contact form at www.porter-cable.com

Postal Mail: Technical Service Manager
Porter-Cable Corporation
4825 Highway 45 North
Jackson, TN 38305

Information regarding the safe and proper operation of this tool is available from the following sources:

Power Tool Institute

1300 Sumner Avenue, Cleveland, OH 44115-2851

www.powertoolinstitute.org

National Safety Council

1121 Spring Lake Drive, Itasca, IL 60143-3201

American National Standards Institute, 25 West 43rd Street, 4 floor, New York, NY 10036 www.ansi.org ANSI 01.1 Safety Requirements for Woodworking Machines, and the U.S. Department of Labor regulations www.osha.gov

SAVE THESE INSTRUCTIONS!

SAFETY GUIDELINES - DEFINITIONS

It is important for you to read and understand this manual. The information it contains relates to protecting YOUR SAFETY and PREVENTING PROBLEMS. The symbols below are used to help you recognize this information.



▲ DANGER

indicates an imminently hazardous situation which, if not avoided, will result in death or serious injury.

▲ WARNING

indicates a potentially hazardous situation which, if not avoided, could result in death or serious injury.

▲ CAUTION

indicates a potentially hazardous situation which, if not avoided, may result in minor or moderate injury.

CAUTION

used without the safety alert symbol indicates a potentially hazardous situation which, if not avoided, may result in property damage.

CALIFORNIA PROPOSITION 65

▲ WARNING

Some dust created by power sanding, sawing, grinding, drilling, and other construction activities contains chemicals known (to the State of California) to cause cancer, birth defects or other reproductive harm. Some examples of these chemicals are:

- lead from lead-based paints
- crystalline silica from bricks and cement and other masonry products
- arsenic and chromium from chemically-treated lumber

Your risk from these exposures varies, depending on how often you do this type of work. To reduce your exposure to these chemicals: work in a well ventilated area, and work with approved safety equipment, always wear NIOSH/OSHA approved, properly fitting face mask or respirator when using such tools.

GENERAL SAFETY RULES

▲ WARNING Read all instructions. Failure to follow all instructions listed below may result in electric shock, fire and/or serious injury. The term "power tool" in all of the warnings listed below refers to your mains-operated (corded) power tool or battery-operated (cordless) power tool.



SAVE THESE INSTRUCTIONS

1) Work area safety

- a) **Keep work area clean and well lit.** Cluttered or dark areas invite accidents.
- b) **Do not operate power tools in explosive atmospheres, such as in the presence of flammable liquids, gases or dust.** Power tools create sparks which may ignite the dust or fumes.
- c) **Keep children and bystanders away while operating a power tool.** Distractions can cause you to lose control.

2) Electrical safety

- a) **Power tool plugs must match the outlet. Never modify the plug in any way. Do not use any adapter plugs with earthed (grounded) power tools.** Unmodified plugs and matching outlets will reduce risk of electric shock.
- b) **Avoid body contact with earthed or grounded surfaces such as pipes, radiators, ranges and refrigerators.** There is an increased risk of electric shock if your body is earthed or grounded.
- c) **Do not expose power tools to rain or wet conditions.** Water entering a power tool will increase the risk of electric shock.
- d) **Do not abuse the cord. Never use the cord for carrying, pulling or unplugging the power tool. Keep cord away from heat, oil, sharp edges or moving parts.** Damaged or entangled cords increase the risk of electric shock.
- e) **When operating a power tool outdoors, use an extension cord suitable for outdoor use.** Use of a cord suitable for outdoor use reduces the risk of electric shock.

3) Personal safety

- a) **Stay alert, watch what you are doing and use common sense when operating a power tool. Do not use a power tool while you are tired or under the influence of drugs, alcohol or medication.** A moment of inattention while operating power tools may result in serious personal injury.
- b) **Use safety equipment. Always wear eye protection.** Safety equipment such as dust mask, non-skid safety shoes, hard hat, or hearing protection used for appropriate conditions will reduce personal injuries.
- c) **Avoid accidental starting. Ensure the switch is in the off-position before plugging in.** Carrying power tools with your finger on the switch or plugging in power tools that have the switch on invites accidents.

GENERAL SAFETY RULES continued

- d) **Remove any adjusting key or wrench before turning the power tool on.** A wrench or a key left attached to a rotating part of the power tool may result in personal injury.
- e) **Do not overreach. Keep proper footing and balance at all times.** This enables better control of the power tool in unexpected situations.
- f) **Dress properly. Do not wear loose clothing or jewelry. Keep your hair, clothing and gloves away from moving parts.** Loose clothes, jewelry or long hair can be caught in moving parts.
- g) **If devices are provided for the connection of dust extraction and collection facilities, ensure these are connected and properly used.** Use of these devices can reduce dust-related hazards.

4) Power tool use and care

- a) **Do not force the power tool. Use the correct power tool for your application.** The correct power tool will do the job better and safer at the rate for which it was designed.
- b) **Do not use the power tool if the switch does not turn it on and off.** Any power tool that cannot be controlled with the switch is dangerous and must be repaired.
- c) **Disconnect the plug from the power source before making any adjustments, changing accessories, or storing power tools.** Such preventive safety measures reduce the risk of starting the power tool accidentally.
- d) **Store idle power tools out of the reach of children and do not allow persons unfamiliar with the power tool or these instructions to operate the power tool.** Power tools are dangerous in the hands of untrained users.
- e) **Maintain power tools. Check for misalignment or binding of moving parts, breakage of parts and any other condition that may affect the power tools operation. If damaged, have the power tool repaired before use.** Many accidents are caused by poorly maintained power tools.
- f) **Keep cutting tools sharp and clean.** Properly maintained cutting tools with sharp cutting edges are less likely to bind and are easier to control.
- g) **Use the power tool, accessories and tool bits etc., in accordance with these instructions and in the manner intended for the particular type of power tool, taking into account the working conditions and the work to be performed.** Use of the power tool for operations different from those intended could result in a hazardous situation.

5) Service









- a) **Have your power tool serviced by a qualified repair person using only identical replacement parts.** This will ensure that the safety of the power tool is maintained.

ADDITIONAL SPECIFIC SAFETY RULES

1. **Hold power tools by insulated gripping surfaces when performing an operation where the cutting tool may contact hidden wiring or its own cord.** Contact with a "live" wire will make exposed metal parts of the tool "live" and shock the operator.
2. **Verify the direction of rotation before starting the tool. Never attempt to change direction of rotation while switch is "ON".** To do so, may damage interlock feature built into switch. Be sure switch is "OFF" and motor has completely stopped before changing direction of rotation.
3. **Wear eye and hearing protection. Always use safety glasses.** Everyday eyeglasses are NOT safety glasses. USE CERTIFIED SAFETY EQUIPMENT. Eye protection equipment should comply with ANSI Z87.1 standards. Hearing equipment should comply with ANSI S3.19 standards.
4. **⚠ WARNING Use of this tool can generate and disburse dust or other airborne particles, including wood dust, crystalline silica dust and asbestos dust.** Direct particles away from face and body. Always operate tool in well ventilated area and provide for proper dust removal. Use dust collection system wherever possible. Exposure to the dust may cause serious and permanent respiratory or other injury, including silicosis (a serious lung disease), cancer, and death. Avoid breathing the dust, and avoid prolonged contact with dust. Allowing dust to get into your mouth or eyes, or lay on your skin may promote absorption of harmful material. Always use properly fitting NIOSH/OSHA approved respiratory protection appropriate for the dust exposure, and wash exposed areas with soap and water.

SAVE THESE INSTRUCTIONS!

SYMBOL		DEFINITION
V	volts
A	amperes
Hz	hertz
W	watts
kW	kilowatts
F	farads
μF	microfarads
l	litres
g	grams
kg	kilograms
bar	bars
Pa	pascals
h	hours
min	minutes
s	seconds
n ₀	no-load speed
.../min or ...min ⁻¹	Revolutions or reciprocations per minute
or d.c.	direct current
or a.c.	alternating current

- 2  two-phase alternating current
- 2N  two-phase alternating current with neutral
- 3  three-phase alternating current
- 3N  three-phase alternating current with neutral
-  A rated current of the appropriate fuse-link in amperes
-  time-lag miniature fuse-link where X is the symbol for the time/current characteristic, as given in IEC 60127
-  protective earth
-  class II tool
- IPXX IP symbol

SAVE THESE INSTRUCTIONS!

MOTOR

Many Porter-Cable tools will operate on either D.C., or single phase 25 to 60 cycle A.C. current and voltage within plus or minus 5 percent of that shown on the specification plate on the tool. Several models, however, are designed for A.C. current only. Refer to the specification plate on your tool for proper voltage and current rating.

CAUTION Do not operate your tool on a current on which the voltage is not within correct limits. Do not operate tools rated A.C. only on D.C. current. To do so may seriously damage the tool.

EXTENSION CORD SELECTION

If an extension cord is used, make sure the conductor size is large enough to prevent excessive voltage drop which will cause loss of power and possible motor damage. A table of recommended extension cord sizes will be found in this section. This table is based on limiting line voltage drop to 5 volts (10 volts for 230 volts) at 150% of rated amperes.

If an extension cord is to be used outdoors, it must be marked with the suffix W-A or W following the cord type designation. For example – SJTW-A to indicate it is acceptable for outdoor use.

RECOMMENDED EXTENSION CORD SIZES FOR USE WITH PORTABLE ELECTRIC TOOLS

		Length of Cord in Feet									
		115V	25 Ft.	50 Ft.	100 Ft.	150 Ft.	200 Ft.	250 Ft.	300 Ft.	400 Ft.	500 Ft.
		230V	50 Ft.	100 Ft.	200 Ft.	300 Ft.	400 Ft.	500 Ft.	600 Ft.	800 Ft.	1000 Ft.
Nameplate Ampere Rating	0-2	18	18	18	18	16	16	14	14	12	12
	2-3	18	18	18	16	14	14	12	12	10	10
	3-4	18	18	16	14	12	12	10	10	8	8
	4-5	18	18	14	12	12	10	10	8	8	6
	5-6	18	16	14	12	10	10	8	8	6	6
	6-8	18	16	12	10	10	8	6	6	4	4
	8-10	18	14	12	10	8	8	6	6	4	4
	10-12	16	14	10	8	8	6	6	4	4	2
	12-14	16	12	10	8	6	6	4	4	2	2
	14-16	16	12	10	8	6	6	4	4	2	2
	16-18	14	12	8	8	6	4	4	2	2	2
	18-20	14	12	8	6	6	4	4	2	2	2

CARTON CONTENTS

Carton contents include the screwdriver, an instruction manual, and a parts list.

FUNCTIONAL DESCRIPTION

FOREWORD

Porter-Cable screwdrivers are designed to install or remove various sizes and types of fasteners.

ASSEMBLY

NOTE: This tool is shipped completely assembled. No assembly time or tools are required.

OPERATION

TO START AND STOP THE TOOL

▲ CAUTION Make sure that the switch is off before connecting the tool to the power source.

Check to see that the switch is “OFF”. Make sure that the power circuit voltage is the same as that shown on the specification plate of the tool. Connect the drill to the power circuit.

1. Squeeze the trigger switch (A) Fig. 1 to start the motor. Release the trigger to stop the motor.
2. A lock button (B) Fig. 1 is provided to keep the motor running without holding the trigger switch “ON”. **TO LOCK** the trigger switch “ON”, squeeze the trigger as far as it will go, push in lock button and release trigger. **TO UNLOCK** the lock button, squeeze the trigger and release, leaving the lock button free to spring out.

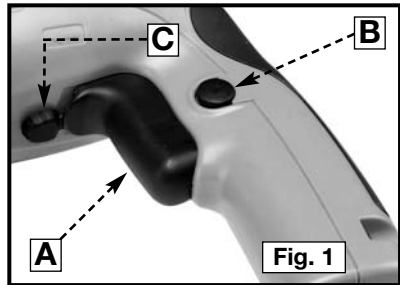

NOTE: The lock button can be engaged only when the tool is running at maximum speed.

▲ CAUTION Never use the lock button when the tool may have to be stopped suddenly.

3. These tools will operate in either the forward direction (clockwise rotation) for drilling holes, or the reverse direction (counter-clockwise rotation) for releasing jammed drill bits. For counter-clockwise rotation, stop the motor by releasing the trigger switch and push the reversing switch (C) Fig. 1 toward the right side of the drill, or in the opposite direction for clockwise rotation.

CAUTION

Never attempt to change direction of rotation while the switch is **“ON”**. To do so, may damage interlock feature built into switch. Be sure that the switch is **“OFF”** and the motor has completely stopped before changing the direction of rotation.

4. VARIABLE SPEED – As the trigger switch is squeezed, the tool speed increases.

TO CHANGE HEX NUTSETTER – MODEL 4640**⚠ WARNING****DISCONNECT TOOL FROM POWER SOURCE.**

1. Pull the Depth Stop Assembly (A) Fig. 2 from the clutch housing (B).
2. Pull the nutsetter (C) Fig. 3 straight out. If it is difficult to remove, grip it with pliers and pull.
3. Push the nutsetter into the screwdriver spindle until the ball in the spindle snaps into the groove in the nutsetter shank.
4. Replace the depth stop assembly and adjust for depth of drive (see **“ADJUST DEPTH STOP, MODEL 4640”**).

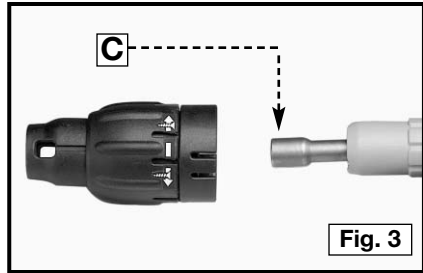
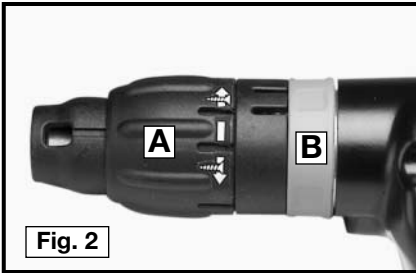
**ADJUST DEPTH STOP – MODEL 4640**

1. Turn the adjusting collar (A) Fig. 2 until the end of the depth stop is flush with the end of the nutsetter. Do not push the nutsetter in. This will engage the internal drive.
2. Drive a test fastener into a piece of scrap material identical to the workpiece. Examine the results of the drive and make any necessary depth stop adjustments.
 - a) To increase the depth of drive, repeat **STEP 1** and turn the adjusting collar so that the end of the nutsetter extends beyond the end of the depth stop.
 - b) To decrease the depth of drive, repeat **STEP 1** and turn the adjusting collar so that the end of the depth stop extends beyond the end of the nutsetter.

Each click of the adjusting collar results in .007" change in the depth of drive.

3. Repeat **STEPS 1** and **2** until the desired result is obtained.

CHANGE BIT HOLDER – MODELS 4630, 4634

⚠ WARNING

DISCONNECT TOOL FROM POWER SOURCE.

1. Pull the Depth Stop Assembly (A) Fig. 4 from the clutch housing.
2. Pull the bit holder (C) Fig. 4 out. If it is difficult to remove, grip it with pliers and pull.

NOTE: You can remove the bit (B) Fig. 4 from the bit holder by pulling it straight out.

3. Push the new bit holder into the spindle and snap it into place.
4. Replace the Depth Stop Assembly and **adjust the depth stop** (see “**ADJUST DEPTH STOP, MODELS 4630 AND 4634**”).

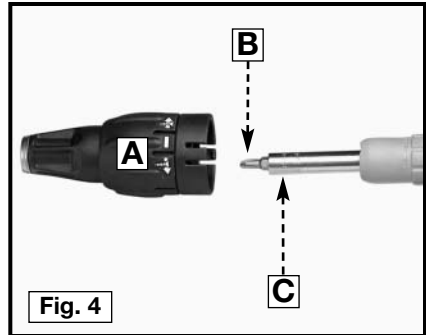

ADJUST DEPTH STOP – MODELS 4630 AND 4634

1. Turn the adjusting collar until the end of the bit extends 3/32" beyond the end of the depth stop. **Do not push the bit holder in.** This will engage the internal drive.
2. Drive a test fastener in the same material as your workpiece. Examine the results and make any additional depth stop adjustments:
 - a) To increase the depth of drive, repeat **STEP 1** and turn the adjusting collar so that the end of the bit extends further than the end of the depth stop.
 - b) To decrease depth of drive, repeat **STEP 1** and turn the adjusting collar so that the end of the bit is closer to the end of depth stop. Each click of the adjusting collar results in a .007" change in the depth of drive.
3. Repeat **STEPS 1** and **2** until the desired result is obtained.

DRIVING DRYWALL SCREWS – MODELS 4630, 4634

NOTE: Maximum size screw for use with this tool is #12 Wood Screw.

1. Install a drywall bit and bit holder in the screwdriver.
2. Set the screwdriver for the correct rotation.
3. Start the screwdriver and place a drywall screw on the bit.

⚠ CAUTION

Do not exert pressure on the screw while performing this operation.

4. Place the end of the screw in the desired location and remove your fingers.
5. Apply forward pressure to the drive screw until the depth stop rests on the surface of the work. Adjust the depth stop so that the fastener head is sunk just below the surface of the wallboard.

DRIVING SELF-DRILLING/TAPPING SCREWS – MODELS 4640

NOTE: Maximum size screws for use with this tool are #12 wood screws and 1/4" self-drilling/tapping screws.

These screws drill and tap their own hole as they are driven. This differs from self-tapping screws in that pre-drilled holes for tapping are not required. To drive these screws:

1. Install the proper nutsetter that fits the screw to the screwdriver.
2. Set the screwdriver for the correct rotation.
3. Start the screwdriver and insert the head of the screw in the nutsetter.

⚠ CAUTION Do not exert pressure on the screw while performing this operation.

4. Place the end of the screw in the desired location and remove your fingers.
5. Apply forward pressure to drive screw until depth stop rests on the surface of the work. Adjust the depth stop so that the fastener head seats firmly on the work. Avoid seating the fastener too deep to prevent shearing off the head.

TO REMOVE SCREWS – ALL MODELS

1. Remove the Depth Stop Assembly.
2. Install a proper bit that fits the screw.
3. Set the screwdriver for reverse rotation.
4. Place the bit on the screw and apply forward pressure.
5. Start the screwdriver.

TROUBLESHOOTING

For assistance with your tool, visit our website at www.porter-cable.com for a list of service centers or call the Porter-Cable help line at 1-800-487-8665.

MAINTENANCE

CHECK CLUTCH CONDITION

⚠ WARNING DISCONNECT TOOL FROM POWER SOURCE.

Periodically, check the screwdriver clutch jaws for wear by removing the screwdriver mechanism housing (A) Fig. 5 from the power unit.

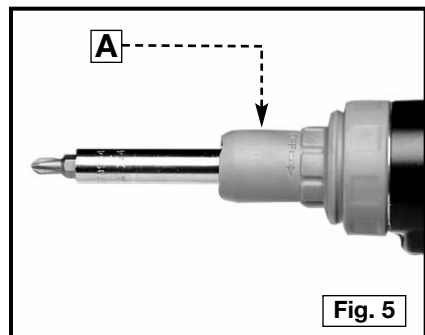

NOTE: The clutch housing is attached to the power unit with **left-hand** threads. Remove the depth-stop assembly from the clutch housing by pulling it straight off. Remove the clutch housing by turning the clutch housing clockwise.

NOTE: Be careful not to lose the small spring that is in the end of the power unit spindle shaft.

Note the condition of the 3-jaw clutch faces on the power unit and screwdriver mechanism. If they are badly rounded where the angular face meets the top surface (or appear otherwise worn or faulty), or if the clutch elements are not securely held in place on their respective shafts by the snap rings, return the entire tool to your AUTHORIZED PORTER-CABLE SERVICE STATION for service.

If the jaws are not seriously worn and no other apparent faults show up in the mechanism, clear the mechanism and all internal areas of chips or other foreign material. Brush a thin coat of PORTER-CABLE gear lubricant on the clutch elements and surrounding areas. Attach the screwdriver mechanism to the power unit. Be sure the spring is in the spindle shaft.

NOTE: The housing threads are left-hand thread.

KEEP TOOL CLEAN

Periodically blow out all air passages with dry compressed air. All plastic parts should be cleaned with a soft damp cloth. NEVER use solvents to clean plastic parts. They could possibly dissolve or otherwise damage the material.

▲WARNING Wear ANSI Z87.1 safety glasses while using compressed air.

FAILURE TO START

Should your tool fail to start, check to make sure the prongs on the cord plug are making good contact in the outlet. Also, check for blown fuses or open circuit breakers in the line.

LUBRICATION

This tool has been lubricated with a sufficient amount of high grade lubricant for the life of the unit under normal operating conditions. No further lubrication is necessary.

BRUSH INSPECTION (If applicable)

For your continued safety and electrical protection, brush inspection and replacement on this tool should ONLY be performed by an AUTHORIZED PORTER-CABLE SERVICE STATION or a PORTER-CABLE•DELTA FACTORY SERVICE CENTER.

At approximately 100 hours of use, take or send your tool to your nearest authorized Porter-Cable Service Station to be thoroughly cleaned and inspected. Have worn parts replaced and lubricated with fresh lubricant. Have new brushes installed, and test the tool for performance.

Any loss of power before the above maintenance check may indicate the need for immediate servicing of your tool. DO NOT CONTINUE TO OPERATE TOOL UNDER THIS CONDITION. If proper operating voltage is present, return your tool to the service station for immediate service.

SERVICE

REPLACEMENT PARTS

When servicing use only identical replacement parts. For a service parts list or to learn more about Porter-Cable visit our website at www.porter-cable.com

SERVICE AND REPAIRS

All quality tools will eventually require servicing, or replacement of parts due to wear from normal use. For assistance with your tool, visit our website at www.porter-cable.com for a list of service centers or call the Customer Care Department at **1-800-487-8665**. All repairs made by our service centers are fully guaranteed against defective material and workmanship. We cannot guarantee repairs made or attempted by others.

Should you have any questions about your tool, feel free to write us at any time. In any communications, please give all information shown on the nameplate of your tool (model number, type, serial number, etc.).

ACCESSORIES

A complete line of accessories is available from your Porter-Cable•Delta Supplier, Porter-Cable•Delta Factory Service Centers, and Porter-Cable Authorized Service Stations. Please visit our Web Site www.porter-cable.com for a catalog or for the name of your nearest supplier.

▲ WARNING Since accessories other than those offered by Porter-Cable•Delta have not been tested with this product, use of such accessories could be hazardous. For safest operation, only Porter-Cable•Delta recommended accessories should be used with this product.

WARRANTY

PORTER-CABLE LIMITED ONE YEAR WARRANTY

Porter-Cable warrants its Professional Power Tools for a period of one year from the date of original purchase. We will repair or replace at our option, any part or parts of the product and accessories covered under this warranty which, after examination, proves to be defective in workmanship or material during the warranty period. For repair or replacement return the complete tool or accessory, transportation prepaid, to your nearest Porter-Cable Service Center or Authorized Service Station. Proof of purchase may be required. This warranty does not apply to repair or replacement required due to misuse, abuse, normal wear and tear or repairs attempted or made by other than our Service Centers or Authorized Service Stations.

ANY IMPLIED WARRANTY, INCLUDING THE IMPLIED WARRANTIES OF MERCHANTABILITY AND FITNESS FOR A PARTICULAR PURPOSE, WILL LAST ONLY FOR ONE (1) YEAR FROM THE DATE OF PURCHASE.

To obtain information on warranty performance please write to: PORTER-CABLE CORPORATION, 4825 Highway 45 North, Jackson, Tennessee 38305; Attention: Product Service. THE FOREGOING OBLIGATION IS PORTER-CABLE'S SOLE LIABILITY UNDER THIS OR ANY IMPLIED WARRANTY AND UNDER NO CIRCUMSTANCES SHALL PORTER-CABLE BE LIABLE FOR ANY INCIDENTAL OR CONSEQUENTIAL DAMAGES. Some states do not allow limitations on how long an implied warranty lasts or the exclusion or limitation of incidental or consequential damages, so the above limitation or exclusion may not apply to you.

This warranty gives you specific legal rights and you may also have other legal rights which vary from state to state.

PORTER-CABLE • DELTA SERVICE CENTERS (CENTROS DE SERVICIO DE PORTER-CABLE • DELTA) (CENTRE DE SERVICE PORTER-CABLE • DELTA)

**Parts and Repair Service for Porter-Cable • Delta Power Tools are Available at These Locations
(Obtenga Refacción de Partes o Servicio para su Herramienta en los Siguientes Centros de Porter-Cable • Delta)
(Locations où vous trouverez les pièces de rechange nécessaires ainsi qu'un service d'entretien)**

ARIZONA
Phoenix 85013-2906
4501 N. 7th Ave.
Phone: (602) 279-6414
Fax: (602) 279-5470

CALIFORNIA
Ontario 91761 (Los Angeles)
3949A East Guasti Road
Phone: (909) 390-5555
Fax: (909) 390-5554

San Diego 92111
7290 Clairemont Mesa Blvd.
Phone: (858) 279-2011
Fax: (858) 279-0362

San Leandro 94577 (Oakland)
3039 Teagarden Street
Phone: (510) 357-9762
Fax: (510) 357-7939

COLORADO
Denver 80223
700 West Mississippi Ave.
Phone: (303) 922-8325
Fax: (303) 922-0245

FLORIDA
Davie 33314 (Miami)
4343 South State Rd. 7 (441)
Unit #107
Phone: (954) 321-6635
Fax: (954) 321-6638

Tampa 33634
4909 West Waters Ave.
Phone: (813) 884-0434
Fax: (813) 888-5997

GEORGIA
Forest Park 30297 (Atlanta)
5442 Frontage Road,
Suite 112
Phone: (404) 608-0006
Fax: (404) 608-1123

ILLINOIS
Addison 60101 (Chicago)
400 South Rohlwing Rd.
Phone: (630) 424-8805
Fax: (630) 424-8895

Woodridge 60517 (Chicago)
2033 West 75th Street
Phone: (630) 910-9200
Fax: (630) 910-0360

KANSAS
Overland Park 66214
9201 Quivira Road
Phone: (913) 495-4330
Fax: (913) 495-4378

MARYLAND
Elkridge 21075 (Baltimore)
7397-102 Washington Blvd.
Phone: (410) 799-9394
Fax: (410) 799-9398

MASSACHUSETTS
Franklin 02038 (Boston)
Franklin Industrial Park
101E Constitution Blvd.
Phone: (508) 520-8802
Fax: (508) 528-8089

MICHIGAN
Madison Heights 48071 (Detroit)
30475 Stephenson Highway
Phone: (248) 597-5000
Fax: (248) 597-5004

MINNESOTA
Eden Prairie 55344
9709 Valley View Road
Phone: (952) 884-9191
Fax: (952) 884-3750

MISSOURI
St. Louis 63146
11477 Page Service Drive
Phone: (314) 997-9100
Fax: (314) 997-9183

NEW YORK
Flushing 11365-1595 (N.Y.C.)
175-25 Horace Harding Expwy.
Phone: (718) 225-2040
Fax: (718) 423-9619

NORTH CAROLINA
Charlotte 28270
9129 Monroe Road, Suite 115
Phone: (704) 841-1176
Fax: (704) 708-4625

OHIO
Columbus 43229
1948 Schrock Road
Phone: (614) 895-3112
Fax: (614) 895-3187

Cleveland 44125
8001 Sweet Valley Drive Unit #19
Phone: (216) 447-9030
Fax: (216) 447-3097

OREGON
Portland 97230
14811 North East Airport Way
Phone: (503) 255-6556
Fax: (503) 255-6543

PENNSYLVANIA
Willow Grove 19090 (Philadelphia)
520 North York Road
Phone: (215) 658-1430
Fax: (215) 658-1433

TEXAS
Carrollton 75006 (Dallas)
1300 Interstate 35 N, Suite 112
Phone: (972) 446-2996
Fax: (972) 446-8157

Houston 77022-2122
536 East Tidwell Rd.
Phone: (713) 692-7111
Fax: (713) 692-1107

WASHINGTON
Auburn 98001 (Seattle)
3320 West Valley HWY, North
Building D, Suite 111
Phone: (253) 333-8353
Fax: (253) 333-9613

Authorized Service Stations are located in many large cities. Telephone **800-487-8665** or **731-541-6042** for assistance locating one. Parts and accessories for Porter-Cable • Delta products should be obtained by contacting any Porter-Cable • Delta Distributor, Authorized Service Center, or Porter-Cable • Delta Factory Service Center. If you do not have access to any of these, call **888-848-5175** and you will be directed to the nearest Porter-Cable • Delta Factory Service Center. Las Estaciones de Servicio Autorizadas están ubicadas en muchas grandes ciudades. Llame al **800-487-8665** ó al **731-541-6042** para obtener asistencia a fin de localizar una. Las piezas y los accesorios para los productos Porter-Cable • Delta deben obtenerse poniéndose en contacto con cualquier distribuidor Porter-Cable • Delta, Centro de Servicio Autorizado o Centro de Servicio de Fábrica Porter-Cable • Delta. Si no tiene acceso a ninguna de estas opciones, llame al **888-848-5175** y le dirijirán al Centro de Servicio de Fábrica Porter-Cable • Delta más cercano. Des centres de service agréés sont situés dans beaucoup de grandes villes. Appelez au **800-487-8665** ou au **731-541-6042** pour obtenir de l'aide pour en repérer un. Pour obtenir des pièces et accessoires pour les produits Porter-Cable • Delta, s'adresser à tout distributeur Porter-Cable • Delta, centre de service agréé ou centre de service d'usine Porter-Cable • Delta. Si vous n'avez accès à aucun de ces centres, appeler le **888-848-5175** et on vous dirigera vers le centre de service d'usine Porter-Cable • Delta le plus proche.

CANADIAN PORTER-CABLE • DELTA SERVICE CENTERS

ALBERTA
Bay 6, 2520-23rd St. N.E.
Calgary, Alberta
T2E 8L2
Phone: (403) 735-6166
Fax: (403) 735-6144

BRITISH COLUMBIA
8520 Baxter Place
Burnaby, B.C.
V5A 4T8
Phone: (604) 420-0102
Fax: (604) 420-3522

MANITOBA
1699 Dublin Avenue
Winnipeg, Manitoba
R3H 0H2
Phone: (204) 633-9259
Fax: (204) 632-1976

ONTARIO
505 Southgate Drive
Guelph, Ontario
N1H 6M7
Phone: (519) 767-4132
Fax: (519) 767-4131

QUÉBEC
1515 Ave.
St-Jean Baptiste, Suite 160
Québec, P.Q.
G2E 5E2
Phone: (418) 877-7112
Fax: (418) 877-7123

1447, Bégin
St-Laurent, (Mt), P.Q.
H4R 1V8
Phone: (514) 336-8772
Fax: (514) 336-3505

The following are trademarks of PORTER-CABLE • DELTA (Las siguientes son marcas registradas de PORTER-CABLE • DELTA S.A.) (Les marques suivantes sont des marques de fabricant de la PORTER-CABLE • DELTA): Auto-Set®, BAMMER®, B.O.S.S.®, Builder's Saw®, Contractor's Saw®, Contractor's Saw II™, Delta®, DELTACRAFT®, DELTAGRAM™, Delta Series 2000™, DURATRONIC™, Emc2™, FLEX®, Flying Chips™, FRAME SAW®, Grip Vac™, Homecraft®, INNOVATION THAT WORKS™, Jet-Lock®, JETSTREAM™, 'kickstand', LASERLOC®, MICRO-SET®, Micro-Set®, MIDI LATHE®, MORTEN™, NETWORK™, OMNIJIG®, POCKET CUTTER®, PORTA-BAND®, PORTA-PLANE®, PORTER-CABLE® & (design), PORTER-CABLE® PROFESSIONAL POWER TOOLS, PORTER-CABLE REDEFINING PERFORMANCE™, Posi-Matic™, Q-3® & (design), QUICKSAND® & (design), QUICKSET™, QUICKSET II®, QUICKSET PLUS™, RIPTIDE™ & (design), SAFE GUARD II®, SAFE-LOC®, Sanding Center®, SANDTRAP® & (design), SAW BOSS®, Sawbuck™, Sidekick®, SPEED-BLOC®, SPEEDMATIC®, SPEEDTRONIC®, STAIR EASE®, The American Woodshop® & (design), The Lumber Company® & (design), THE PROFESSIONAL EDGE®, THE PROFESSIONAL SELECT®, THIN-LINE™, TIGER®, TIGER CUB®, TIGER SAW®, TORQBUSTER®, TORQ-BUSTER®, TRU-MATCH™, TWIN-LITE™, UNIGUARD®, Unifence®, UNIFEEDER™, Unihand™, Uniplane™, Unirip®, Unisaw®, Univise®, Versa-Feeder®, VERSA-PLANE®, WHISPER SERIES®, WOODWORKER'S CHOICE™.

Trademarks noted with ™ and ® are registered in the United States Patent and Trademark Office and may also be registered in other countries. Las Marcas Registradas con el signo de ™ y ® son registradas por la Oficina de Registros y Patentes de los Estados Unidos y también pueden estar registradas en otros países. Marques déposées, indiquées par la lettre ™ et ®, sont déposées au Bureau des brevets d'invention et marques déposées aux États-Unis et pourraient être déposées aux autres pays.