

**ESPAÑOL: PÁGINA 15  
FRANÇAISE : PAGE 29**

# Instruction manual

# Drywall Sander



MODEL 7800  
MODEL 7801

Patent Pending

To learn more about Porter-Cable visit our website at:

<http://www.porter-cable.com>



Copyright © 2002 Porter-Cable Corporation

### **IMPORTANT**

*Please make certain that the person who is to use this equipment carefully reads and understands these instructions before starting operations.*

The Model and Serial No. plate is located on the main housing of the tool. Record these numbers in the spaces below and retain for future reference.

Model No. \_\_\_\_\_

Type \_\_\_\_\_

Serial No. \_\_\_\_\_

Part No. 904374 - 06-26-02

**⚠ WARNING: SOME DUST CREATED BY POWER SANDING, SAWING, GRINDING, DRILLING, AND OTHER CONSTRUCTION ACTIVITIES**

contains chemicals known to cause cancer, birth defects or other reproductive harm. Some examples of these chemicals are:

- lead from lead-based paints,
- crystalline silica from bricks and cement and other masonry products, and
- arsenic and chromium from chemically-treated lumber.

Your risk from these exposures varies, depending on how often you do this type of work. To reduce your exposure to these chemicals: work in a well ventilated area, and work with approved safety equipment, such as those dust masks that are specially designed to filter out microscopic particles.

## GENERAL SAFETY RULES

**⚠ WARNING: READ AND UNDERSTAND ALL INSTRUCTIONS.** Failure to follow all instructions listed below, may result in electric shock, fire and/or serious personal injury.

SAVE THESE INSTRUCTIONS.

### WORK AREA

1. **Keep your work area clean and well lit.** Cluttered benches and dark areas invite accidents.
2. **Do not operate power tools in explosive atmospheres, such as in the presence of flammable liquids, gases, or dust.** Power tools create sparks which may ignite the dust or fumes.
3. **Keep bystanders, children, and visitors away while operating a power tool.** Distractions can cause you to lose control.

### ELECTRICAL SAFETY

1. **Grounded tools must be plugged into an outlet properly installed and grounded in accordance with all codes and ordinances. Never remove the grounding prong or modify the plug in any way. Do not use any adapter plugs. Check with a qualified electrician if you are in doubt as to whether the outlet is properly grounded.** If the tools should electrically malfunction or break down, grounding provides a low resistance path to carry electricity away from the user.
2. **Avoid body contact with grounded surfaces such as pipes, radiators, ranges and refrigerators.** There is an increased risk of electric shock if your body is grounded.
3. **Don't expose power tools to rain or wet conditions.** Water entering a power tool will increase the risk of electric shock.
4. **Do not abuse the cord. Never use the cord to carry the tools or pull the plug from an outlet. Keep cord away from heat, oil, sharp edges or moving parts. Replace damaged cords immediately.** Damaged cords increase the risk of electric shock.
5. **When operating a power tool outside, use an outdoor extension cord marked "W-A" or "W".** These cords are rated for outdoor use and reduce the risk of electric shock.

### PERSONAL SAFETY

1. **Stay alert, watch what you are doing, and use common sense when operating a power tool. Do not use tool while tired or under the influence of drugs, alcohol, or medication.** A moment of inattention while operating power tools may result in serious personal injury.

- 2. Dress properly. Do not wear loose clothing or jewelry. Contain long hair. Keep your hair, clothing, and gloves away from moving parts.** Loose clothes, jewelry, or long hair can be caught in moving parts.
- 3. Avoid accidental starting. Be sure switch is OFF before plugging in.** Carrying tools with your finger on the switch or plugging in tools that have the switch ON invites accidents.
- 4. Remove adjusting keys or wrenches before turning the tool ON.** A wrench or a key that is left attached to a rotating part of the tool may result in personal injury.
- 5. Do not overreach. Keep proper footing and balance at all times.** Proper footing and balance enables better control of the tool in unexpected situations.
- 6. Use safety equipment. Always wear eye protection.** Dust mask, non-skid safety shoes, hard hat, or hearing protection must be used for appropriate conditions.

## TOOLS USE AND CARE

- 1. Use clamps or other practical way to secure and support the workpiece to a stable platform.** Holding the work by hand or against your body is unstable and may lead to loss of control.
- 2. Do not force tool. Use the correct tool for your application.** The correct tool will do the job better and safer at the rate for which it is designed.
- 3. Do not use tool if switch does not turn it ON or OFF.** Any tool that cannot be controlled with the switch is dangerous and must be repaired.
- 4. Disconnect the plug from the power source before making any adjustments, changing accessories, or storing the tool.** Such preventive safety measures reduce the risk of starting the tool accidentally.
- 5. Store idle tools out of reach of children and other untrained persons.** Tools are dangerous in the hands of untrained users.
- 6. Maintain tools with care. Keep cutting tools sharp and clean.** Properly maintained tools, with sharp cutting edges are less likely to bind and are easier to control.
- 7. Check for misalignment or binding of moving parts, breakage of parts, and any other condition that may affect the tool's operation. If damaged, have the tool serviced before using.** Many accidents are caused by poorly maintained tools.
- 8. Use only accessories that are recommended by the manufacturer for your model.** Accessories that may be suitable for one tool may become hazardous when used on another tool.







## SERVICE

- 1. Tool service must be performed only by qualified repair personnel.** Service or maintenance performed by unqualified personnel could result in a risk of injury.
2. When servicing a tool, use only identical replacement parts. Follow instructions in the Maintenance Section of this manual. Use of unauthorized parts or failure to follow Maintenance Instructions may create a risk of electric shock or injury.

**ADDITIONAL SAFETY RULES FOR DRYWALL SANDER**

1. **USE A RESPIRATOR approved by NIOSH for “Dust and Mist”.** Ventilate work area and/or use a dust collector. Continued and prolonged exposure to high concentrations of airborne dust may affect the respiratory system function.
2. **MAINTAIN FIRM FOOTING AND BALANCE.** Use appropriate scaffolding. Do not overreach.
3. **SANDING OF LEAD-BASED PAINT IS NOT RECOMMENDED.** Lead based paint should only be removed by a professional.
4. **SOME WOOD CONTAINS PRESERVATIVES WHICH CAN BE TOXIC.** Take extra care to prevent inhalation and skin contact when working with these materials. Request and follow any safety information available from your material supplier.
5.  **WARNING:** This tool was designed for certain applications. **DO NOT** modify and/or use it for any application other than for which it was designed. If you have questions relative to its application **DO NOT** use the tool until you have written Porter-Cable and we have advised you.

Technical Service Manager  
 Porter-Cable Corporation  
 4825 Highway 45 North  
 Jackson, TN 38305

SYMBOL	DEFINITION
V	volts
A	amperes
Hz	hertz
W	watts
kW	kilowatts
μF	microfarads
l	liters
kg	kilograms
N/cm <sup>2</sup>	newtons per square centimeter
Pa	pascals
h	hours
min	minutes
s	seconds
	alternating current
3 	three-phase alternating current
3N 	three-phase alternating current with neutral
— — —	direct current
n <sub>0</sub>	no load
	alternating or direct current
	Class II Construction
	splash-proof construction
	watertight construction
.../min	revolutions or reciprocation per minute

## REPLACEMENT PARTS

When servicing use only identical replacement parts.

## MOTOR

Many Porter-Cable tools will operate on either D.C., or single phase 25 to 60 cycle A.C. current and voltage within plus or minus 5 percent of that shown on the specification plate on the tool. Several models, however, are designed for A.C. current only. Refer to the specification plate on your tool for proper voltage and current rating.

**CAUTION:** Do not operate your tool on a current on which the voltage is not within correct limits. Do not operate tools rated A.C. only on D.C. current. To do so may seriously damage the tool.

## EXTENSION CORD SELECTION

If an extension cord is used, make sure the conductor size is large enough to prevent excessive voltage drop which will cause loss of power and possible motor damage. A table of recommended extension cord sizes will be found in this section. This table is based on limiting line voltage drop to 5 volts (10 volts for 230 volts) at 150% of rated amperes.

If an extension cord is to be used outdoors it must be marked with the suffix W-A or W following the cord type designation. For example – SJTW-A to indicate it is acceptable for outdoor use.

RECOMMENDED EXTENSION CORD SIZES FOR USE WITH PORTABLE ELECTRIC TOOLS

		Length of Cord in Feet									
		115V	25 Ft.	50 Ft.	100 Ft.	150 Ft.	200 Ft.	250 Ft.	300 Ft.	400 Ft.	500 Ft.
		230V	50 Ft.	100 Ft.	200 Ft.	300 Ft.	400 Ft.	500 Ft.	600 Ft.	800 Ft.	1000 Ft.
Nameplate Ampere Rating	0-2	18	18	18	16	16	14	14	12	12	
	2-3	18	18	16	14	14	12	12	10	10	
	3-4	18	18	16	14	12	12	10	10	8	
	4-5	18	18	14	12	12	10	10	8	8	
	5-6	18	16	14	12	10	10	8	8	6	
	6-8	18	16	12	10	10	8	6	6	6	
	8-10	18	14	12	10	8	8	6	6	4	
	10-12	16	14	10	8	8	6	6	4	4	
	12-14	16	12	10	8	6	6	6	4	2	
	14-16	16	12	10	8	6	6	4	4	2	
	16-18	14	12	8	8	6	4	4	2	2	
	18-20	14	12	8	6	6	4	4	2	2	

## ADDITIONAL SAFETY RULES FOR PAINT REMOVAL

**⚠ WARNING: Extreme care should be taken when removing paint. The peelings, residue, and vapors of paint may contain lead, which is poisonous. Exposure to even low levels of lead can cause irreversible brain and nervous system damage; young and unborn children are particularly vulnerable.**

Before beginning any paint removal process you should determine whether the paint you are removing contains lead. This can be done by your local health department or by a professional who uses a paint analyzer to check for lead.

**LEAD-BASED PAINT SHOULD ONLY BE REMOVED BY A PROFESSIONAL.**

Persons removing paint should follow these guidelines:

- 1. KEEP THE WORK AREA WELL VENTILATED.** Open the windows and put an exhaust fan in one of them. Be sure the fan is moving air from inside to outside.
- 2. REMOVE OR COVER** any carpets, rugs, furniture, clothing, cooking utensils and air ducts.
- 3. PLACE DROP CLOTHS** in the work area to catch any paint chips or peelings. Wear protective clothing such as extra work shirts, overalls and hats.
- 4. WORK IN ONE ROOM AT A TIME.** Furnishings should be removed or placed in the center of the room and covered. Work areas should be sealed off from the rest of the dwelling by sealing doorways with drop cloths.
- 5. CHILDREN, PREGNANT OR POTENTIALLY PREGNANT** women and nursing mothers should not be present in the work area until the work is done and all clean up is complete.
- 6. WEAR A DUST RESPIRATOR** or a dual (dust and fume) respirator mask which has been approved by the Occupational Safety and Health Administration (OSHA), the National Institute of Safety and Health (NIOSH), or the United States Bureau of Mines. These masks and replaceable filters are readily available at major hardware stores. Be sure the mask fits. Beards and facial hair may keep the masks from sealing properly. Change filters often. **DISPOSABLE PAPER MASKS ARE NOT ADEQUATE.**
- 7. KEEP FOOD AND DRINK** out of the work area. Wash hands, arms and face and rinse mouth before eating or drinking. Do not smoke or chew gum or tobacco in the work area.
- 8. CLEAN UP ALL REMOVED PAINT** and dust by wet mopping the floors. Use a wet cloth to clean all walls, sills and any other surfaces where paint or dust is clinging. **DO NOT SWEEP**, dry dust or vacuum. Use a high phosphate detergent or trisodium (TSP) to wash and mop areas.
- 9. AT THE END OF EACH WORK SESSION** put the paint chips and debris in a double plastic bag, close it with tape or twist ties and dispose of properly.
- 10. REMOVE PROTECTIVE CLOTHING** and work shoes in the work area to avoid carrying dust into the rest of the dwelling. Wash work clothes separately. Wipe shoes off with a wet rag that is then washed with the work clothes. Wash hair and body thoroughly with soap and water.

## OPERATING INSTRUCTIONS

### FUNCTIONAL DESCRIPTION

The Porter-Cable Drywall Sander is designed for sanding walls and ceilings made of drywall or plaster. The Sander provides a superior finish, and is faster than conventional finishing methods for both new construction and renovation work. Clean-up time for **Model 7800** is minimized by the use of an external vacuum cleaner attached to the sander.

### ABRASIVE DISC SELECTION

The Drywall Sander is shipped with a 100 grit, abrasive disc installed. This abrasive is suitable for most applications. Abrasive discs of 120 grit and 150 grit are available for situations requiring a smoother finish.

**CAUTION: Do not attempt to use any abrasives other than those recommended by Porter-Cable.**

### HOW TO HOLD A DRYWALL SANDER

The Drywall Sander should be held with both hands on the main tube (A) Fig. 1. The hands may be positioned anywhere along the main tube to provide the best combination of reach and leverage for the particular application.

**CAUTION: Keep your hands on the main tube (A) Fig. 1. Keep away from the sanding head area. The sanding head swivels in multiple directions and could pinch your hand.**

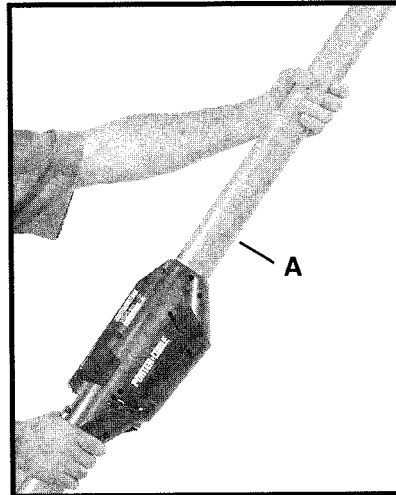

Fig. 1

### CONNECT MODEL 7800 DRYWALL SANDER TO VACUUM CLEANER

The following items are furnished with the **Model 7800** Drywall Sander:

1. One vacuum hose. The hose is 13 feet long with a standard 1-1/4" vacuum cleaner connector on one end and a special swivel connector on the Sander end. It has a static dissipating feature to dissipate static electrical charges that are sometimes experienced when recovering drywall dust.
2. One 1 1/4" to 2 1/2" adapter (adapts the 1 1/4" hose connector to fit a 2 1/2" vacuum cleaner).
3. Three straps to connect the Sander cord to the vacuum hose (to prevent tangling).

## INSTALLATION

1. Install the special drywall dust bag into your vacuum cleaner, following the instructions supplied with the vacuum cleaner. If this dust bag does not fit your vacuum cleaner correctly, purchase and install a suitable filter bag that is rated for drywall dust.

**CAUTION: Failure to use a dust bag rated for drywall dust will increase the level of airborne dust particles in the work area. Continued and prolonged exposure to high concentrations of airborne dust may affect your respiratory system function.**

2. Connect the vacuum hose to the Drywall Sander. Open the Drywall Sander's hose connector by turning the large nut (A) Fig. 2 counterclockwise a few turns. Push the vacuum hose swivel connector (B) Fig. 2 into the Drywall Sander connector and seat firmly. Turn the large nut clockwise to tighten the connector.

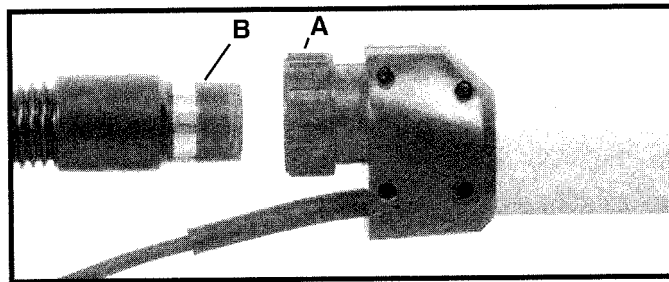

Fig. 2

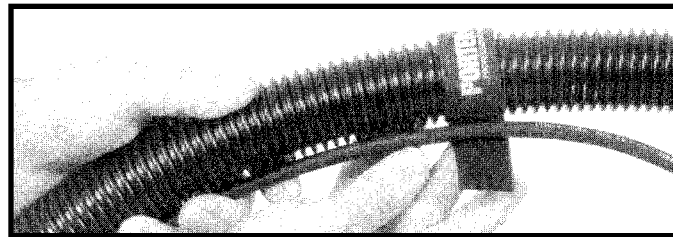

Fig. 3

3. Install the three "hook & loop" type straps to prevent tangling of the Sander cord and the vacuum hose. Lay the cord and the vacuum hose out parallel to each other. Place a strap approximately two feet from each end and place the third strap halfway between the other two. Wrap the long end of each strap around the vacuum hose and close. Wrap the short end of each strap around the cord and close (Fig. 3).

4. Connect the vacuum hose to your vacuum cleaner. Use the 1-1/4" to 2-1/2" adapter if necessary. If your vacuum cleaner requires a special connector (something other than the standard 1-1/4" to 2-1/2" connectors supplied with the Drywall Sander), contact your vacuum cleaner supplier for the proper adapter.



## TO START AND STOP DRYWALL SANDER

Be certain that the power circuit voltage is the same as that shown on the specification plate of the tool, and that the switch is OFF. Connect the tool to the power circuit.

The Drywall Sander is equipped with a “rocker” type switch (A) Fig. 4. The top end of the switch button is labeled “OFF”, and the bottom end of the button is labeled “ON”. To start the Sander, press the bottom (ON) end of the switch. To stop the Sander: press the top (OFF) end of the switch.

## SPEED CONTROL

The **Model 7800** Drywall Sander is equipped with a variable speed control. The speed is adjusted by turning the control knob (B) Fig. 4. The control knob is numbered “1” through “5”. The setting “1” is the slowest speed (approximately 1000 RPM) and “5” is the fastest speed (approximately 2,000 RPM).

Use the higher speed settings for fast stock removal. Use the lower speed setting to reduce removal rate for more precise control. The **Model 7801** Drywall Sander has a constant speed of 2,000 RPM.

## BRUSH-TYPE SKIRT

On the **Model 7800**, a brush-type skirt (A) Fig. 5, surrounds the abrasive pad. This skirt serves two purposes: (1) It extends below the surface of the abrasive pad so that it contacts the work surface first, preventing the abrasive from “gouging” the work. (2) It helps contain the drywall dust until the vacuum cleaner pulls it away.

Replace the skirt if it is damaged or if it is worn excessively. Replacement skirts are available from any Porter-Cable Service Center (see the list in back of this manual).

Since the **Model 7801** requires no vacuum cleaner, the skirt is shorter, but provides the same purpose as #1 in the preceding paragraph.

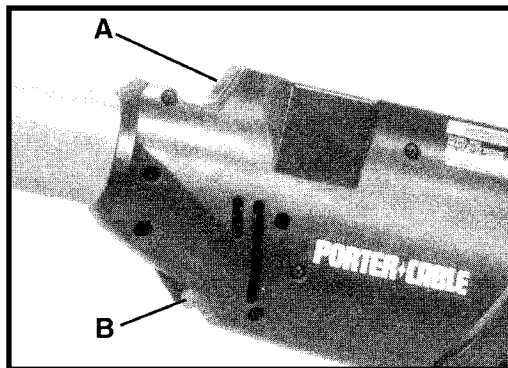

Fig. 4

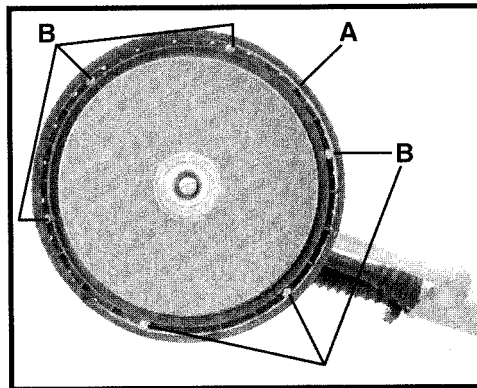

Fig. 5

**CAUTION:** DISCONNECT TOOL FROM POWER SOURCE.

## TO REPLACE SKIRT

- (1) Remove abrasive pad (see ABRASIVE PAD REPLACEMENT).
- (2) Use phillips screwdriver to remove the six retaining screws (B) Fig. 5.
- (3) Lift the skirt out of housing.
- (4) Position new skirt to housing and install the six retaining screws. (5) Replace the abrasive pad.

## SANDING DRYWALL

The Drywall Sander has a unique articulating sanding head. the head can swivel in multiple directions, allowing the abrasive pad to conform to the work surface (Figs. 6, 7, and 8). This action enables the operator to sand the top, middle, and bottom of a wall or ceiling without changing position.

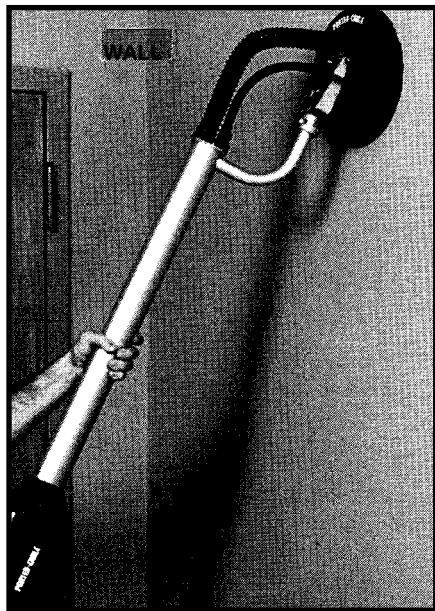

Fig. 6

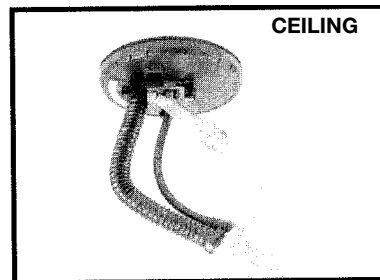

Fig. 7

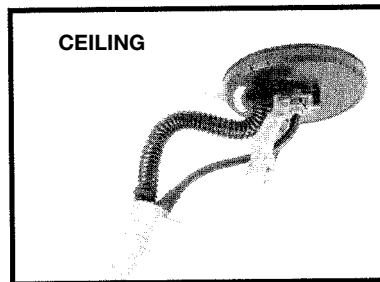

Fig. 8

1. Turn the vacuum cleaner switch "ON". (**Model 7800** only).

**CAUTION: Wear a respirator approved by NIOSH for "Dust and Mist".**

2. Turn Drywall Sander switch "ON".
3. Position the Drywall Sander lightly against the work surface. Apply just enough pressure to align the sanding head with the work surface.
4. Apply additional pressure to engage the abrasive pad on the work surface. Move the Sander in an overlapping pattern to smooth the drywall compound down to a "featheredge".

Apply **ONLY** enough pressure to keep the abrasive pad flat against the work. Excessive pressure can cause unacceptable swirl marks and unevenness in the work surface.

Keep the Sander in constant motion while the abrasive pad is in contact with the work surface. Use a steady, sweeping motion. Stopping the Sander on the work, or moving the Sander erratically can cause unacceptable swirl marks and unevenness in the work surface.

**NOTE:** Do not allow rotating abrasive pad to contact sharp protrusions. Contact with protruding objects (nails, screws, electrical boxes, etc.), can severely damage the abrasive pad.

## ABRASIVE PAD REPLACEMENT

**CAUTION:** DISCONNECT TOOL FROM POWER SOURCE.

1. Grasp the abrasive pad and the sander housing to prevent pad rotation.
2. Rotate the pad retaining nut (A) Fig. 9 counterclockwise and remove.
3. Lift off the large metal washer (B) Fig. 9, and the abrasive pad (C) Fig. 9.

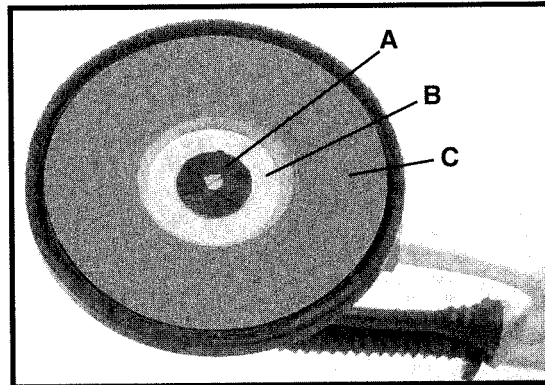

Fig. 9

**NOTE:** When the abrasive pad (C) Fig. 9 is lifted off the Sander, the abrasive back-up disc (A) Fig. 10 is exposed. Please note that this back-up disc is also covered with an abrasive material., and is used ONLY to prevent “slippage” between the back-up disc and the foam-backed abrasive pad. it is NOT suitable for use as a sanding abrasive.  
**DO NOT USE THE SANDER WITHOUT A PROPER ABRASIVE PAD**

Position the new abrasive pad to the back-up disc, and center the hole of the disc on the hub (B) Fig. 10 of the back-up disc.

5. Position the large metal washer (B) Fig. 9, and the retaining nut (A) Fig. 9, to the Sander.
6. Rotate the retaining nut clockwise to hand tighten (while holding the abrasive pad as described in step 1).

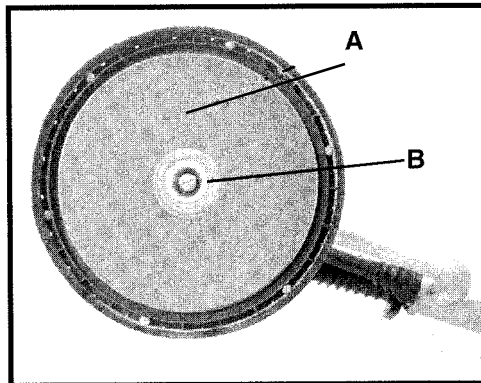

Fig. 10

## TRANSPORTATION AND STORAGE

Keep the Drywall Sander dry during transport and storage. Do not allow anything to press against the abrasive pad. The pad might deform, causing it to sand unevenly. If the pad cannot be protected during transport or storage: remove the abrasive pad and store it separately.

## MAINTENANCE

### KEEP TOOL CLEAN

Periodically blow out all air passages with dry compressed air. All plastic parts should be cleaned with a soft damp cloth. NEVER use solvents to clean plastic parts. They could possibly dissolve or otherwise damage the material.

**CAUTION:** Wear safety glasses while using compressed air.

### FAILURE TO START

Should your tool fail to start, check to make sure the prongs on the cord plug are making good contact in the outlet. Also, check for blown fuses or open circuit breakers in the line.

### LUBRICATION

This tool has been lubricated with a sufficient amount of high grade lubricant for the life of the unit under normal operating conditions. No further lubrication is necessary.

## BRUSH INSPECTION AND LUBRICATION

For your continued safety and electrical protection, brush inspection and replacement on this tool should **ONLY** be performed by an AUTHORIZED PORTER-CABLE SERVICE STATION or a PORTER-CABLE/DELTA FACTORY SERVICE CENTER.

At approximately 100 hours of use, take or send your tool to your nearest authorized Porter-Cable Service Station to be thoroughly cleaned and inspected. Have worn parts replaced and lubricate with fresh lubricant. Have new brushes installed, and test the tool for performance.

Any loss of power before the above maintenance check may indicate the need for immediate servicing of your tool. **DO NOT CONTINUE TO OPERATE TOOL UNDER THIS CONDITION.** If proper operating voltage is present, return your tool to the service station for immediate service.

## SERVICE AND REPAIRS

All quality tools will eventually require servicing or replacement of parts due to wear from normal use. These operations, including brush inspection and replacement, should **ONLY** be performed by either an AUTHORIZED PORTER-CABLE SERVICE STATION or a PORTER-CABLE/DELTA FACTORY SERVICE CENTER. All repairs made by these agencies are fully guaranteed against defective material and workmanship. We cannot guarantee repairs made or attempted by anyone other than these agencies.

Should you have any questions about your tool, feel free to write us at any time. In any communications, please give all information shown on the nameplate of your tool (model number, type, serial number, etc.).

## ACCESSORIES

A complete line of accessories is available from your Porter-Cable • Delta Supplier, Porter-Cable • Delta Factory Service Centers, and Porter-Cable Authorized Service Stations. Please visit our Web Site [www.porter-cable.com](http://www.porter-cable.com) for a catalog or for the name of your nearest supplier.

**⚠ WARNING:** Since accessories other than those offered by Porter-Cable • Delta have not been tested with this product, use of such accessories could be hazardous. For safest operation, only Porter-Cable • Delta recommended accessories should be used with this product.

## **PORTER-CABLE LIMITED ONE YEAR WARRANTY**

Porter-Cable warrants its Professional Power Tools for a period of one year from the date of original purchase. We will repair or replace, at our option, any part or parts of the product and accessories covered under this warranty which, after examination, proves to be defective in workmanship or material during the warranty period. For repair or replacement, return the complete tool or accessory, transportation prepaid, to your nearest Porter-Cable Service Center or Authorized Service Station. Proof of purchase may be required. This warranty does not apply to repair or replacement required due to misuse, abuse, normal wear and tear or repairs attempted or made by other than our Service Centers or Authorized Service Stations.

ANY IMPLIED WARRANTY, INCLUDING THE IMPLIED WARRANTIES OF MERCHANTABILITY AND FITNESS FOR A PARTICULAR PURPOSE, WILL LAST ONLY FOR ONE (1) YEAR FROM THE DATE OF PURCHASE.

To obtain information on warranty performance please write to: PORTER-CABLE CORPORATION, 4825 Highway 45 North, P.O. Box 2468, Jackson, Tennessee 38302-2468; Attention: Product Service. THE FOREGOING OBLIGATION IS PORTER-CABLE'S SOLE LIABILITY UNDER THIS OR ANY IMPLIED WARRANTY AND UNDER NO CIRCUMSTANCES SHALL PORTER-CABLE BE LIABLE FOR ANY INCIDENTAL OR CONSEQUENTIAL DAMAGES. Some states do not allow limitations on how long an implied warranty lasts or the exclusion or limitation of incidental or consequential damages, so the above limitation or exclusion may not apply to you.

This warranty gives you specific legal rights and you may also have other legal rights which vary from state to state.

**PORTER-CABLE • DELTA SERVICE CENTERS  
(CENTROS DE SERVICIO DE PORTER-CABLE • DELTA)  
(CENTRE DE SERVICE PORTER-CABLE • DELTA)**

**Parts and Repair Service for Porter-Cable • Delta Power Tools are Available at These Locations  
(Obtenga Refacción de Partes o Servicio para su Herramienta en los Sigüientes Centros de Porter-Cable • Delta)  
(Locations où vous trouverez les pièces de rechange nécessaires ainsi qu'un service d'entretien)**

<b>ARIZONA</b> Tempe 85282 (Phoenix) 2400 West Southern Avenue Suite 105 Phone: (602) 437-1200 Fax: (602) 437-2200	<b>ILLINOIS</b> Addison 60101 (Chicago) 311 Laura Drive Phone: (630) 628-6100 Fax: (630) 628-0023  Woodridge 60517 (Chicago) 2033 West 75th Street Phone: (630) 910-9200 Fax: (630) 910-0360	<b>MINNESOTA</b> Minneapolis 55429 5522 Lakeland Avenue North Phone: (763) 561-9080 Fax: (763) 561-0653	Cleveland 44125 8001 Sweet Valley Drive Unit #19 Phone: (216) 447-9030 Fax: (216) 447-3097
<b>CALIFORNIA</b> Ontario 91761 (Los Angeles) 3949A East Guasti Road Phone: (909) 390-5555 Fax: (909) 390-5554  San Leandro 94577 (Oakland) 3039 Teagarden Street Phone: (510) 357-9762 Fax: (510) 357-7939	<b>MARYLAND</b> Elkridge 21075 (Baltimore) 7397-102 Washington Blvd. Phone: (410) 799-9394 Fax: (410) 799-9398	<b>MISSOURI</b> North Kansas City 64116 1141 Swift Avenue P.O. Box 12393 Phone: (816) 221-2070 Fax: (816) 221-2897  St. Louis 63119 7574 Watson Road Phone: (314) 968-8950 Fax: (314) 968-2790	<b>OREGON</b> Portland 97230 4916 NE 122 nd Ave. Phone: (503) 252-0107 Fax: (503) 252-2123
<b>FLORIDA</b> Davie 33314 (Miami) 4343 South State Rd. 7 (441) Unit #107 Phone: (954) 321-6635 Fax: (954) 321-6638  Tampa 33609 4538 W. Kennedy Boulevard Phone: (813) 877-9585 Fax: (813) 289-7948	<b>MASSACHUSETTS</b> Braintree 02185 (Boston) 719 Granite Street Phone: (781) 848-9810 Fax: (781) 848-6759  Franklin 02038 (Boston) Franklin Industrial Park 101E Constitution Blvd. Phone: (508) 520-8802 Fax: (508) 528-8089	<b>NEW YORK</b> Flushing 11365-1595 (N.Y.C.) 175-25 Horace Harding Expwy. Phone: (718) 225-2040 Fax: (718) 423-9619	<b>PENNSYLVANIA</b> Willow Grove 19090 520 North York Road Phone: (215) 658-1430 Fax: (215) 658-1433
<b>GEORGIA</b> Forest Park 30297 (Atlanta) 5442 Frontage Road, Suite 112 Phone: (404) 608-0006 Fax: (404) 608-1123	<b>MICHIGAN</b> Madison Heights 48071 (Detroit) 30475 Stephenson Highway Phone: (248) 597-5000 Fax: (248) 597-5004	<b>NORTH CAROLINA</b> Charlotte 28270 9129 Monroe Road, Suite 115 Phone: (704) 841-1176 Fax: (704) 708-4625	<b>TEXAS</b> Carrollton 75006 (Dallas) 1300 Interstate 35 N, Suite 112 Phone: (972) 446-2996 Fax: (972) 446-8157  Houston 77055 West 10 Business Center 1008 Wirt Road, Suite 120 Phone: (713) 682-0334 Fax: (713) 682-4867
		<b>OHIO</b> Columbus 43214 4560 Indianola Avenue Phone: (614) 263-0929 Fax: (614) 263-1238	<b>WASHINGTON</b> Renton 98055 (Seattle) 268 Southwest 43rd Street Phone: (425) 251-6680 Fax: (425) 251-9337

Authorized Service Stations are located in many large cities. Telephone **800-487-8665** or **731-541-6042** for assistance locating one. Parts and accessories for Porter-Cable • Delta products should be obtained by contacting any Porter-Cable • Delta Distributor, Authorized Service Center, or Porter-Cable • Delta Factory Service Center. If you do not have access to any of these, call **888-848-5175** and you will be directed to the nearest Porter-Cable • Delta Factory Service Center. Las Estaciones de Servicio Autorizadas están ubicadas en muchas grandes ciudades. Llame al **800-487-8665** ó al **731-541-6042** para obtener asistencia a fin de localizar una. Las piezas y los accesorios para los productos Porter-Cable • Delta deben obtenerse poniéndose en contacto con cualquier distribuidor Porter-Cable • Delta, Centro de Servicio Autorizado o Centro de Servicio de Fábrica Porter-Cable • Delta. Si no tiene acceso a ninguna de estas opciones, llame al **888-848-5175** y le dirigrán al Centro de Servicio de Fábrica Porter-Cable • Delta más cercano. Des centres de service agréés sont situés dans beaucoup de grandes villes. Appelez au **800-487-8665** ou au **731-541-6042** pour obtenir de l'aide pour en repérer un. Pour obtenir des pièces et accessoires pour les produits Porter-Cable • Delta, s'adresser à tout distributeur Porter-Cable • Delta, centre de service agréé ou centre de service d'usine Porter-Cable • Delta. Si vous n'avez accès à aucun de ces centres, appelez le **888-848-5175** et on vous dirigera vers le centre de service d'usine Porter-Cable • Delta le plus proche.

**CANADIAN PORTER-CABLE • DELTA SERVICE CENTERS**

<b>ALBERTA</b> Bay 6, 2520-23rd St. N.E. Calgary, Alberta T2E 8L2 Phone: (403) 735-6166 Fax: (403) 735-6144	<b>MANITOBA</b> 1699 Dublin Avenue Winnipeg, Manitoba R3H 0H2 Phone: (204) 633-9259 Fax: (204) 632-1976	<b>QUÉBEC</b> 1515 Ave. St-Jean Baptiste, Québec, Québec G2E 5E2 Phone: (418) 877-7112 Fax: (418) 877-7123
<b>BRITISH COLUMBIA</b> 8520 Baxter Place Burnaby, B.C. V5A 4T8 Phone: (604) 420-0102 Fax: (604) 420-3522	<b>ONTARIO</b> 505 Southgate Drive Guelph, Ontario N1H 6M7 Phone: (519) 836-2840 Fax: (519) 767-4131	1447, Begin St-Laurent, (Montréal), Québec H4R 1V8 Phone: (514) 336-8772 Fax: (514) 336-3505

The following are trademarks of PORTER-CABLE • DELTA (Las siguientes son marcas registradas de PORTER-CABLE • DELTA S.A.) (Les marques suivantes sont des marques de fabricant de la PORTER-CABLE • DELTA): BAMMER®, LASERLOC®, OMNIJIG®, POCKET CUTTER®, PORTA-BAND®, PORTA-PLANE®, PORTER-CABLE®, QUICKSAND®, SANDTRAP®, SAW BOSS®, SPEED-BLOC®, SPEEDMATIC®, SPEEDTRONIC®, STAIR-EASE®, THE PROFESSIONAL EDGE®, THE PROFESSIONAL SELECT®, TIGER CUB®, TIGER SAW®, TORQ-BUSTER®, VERSA-PLANE®, WHISPER SERIES®, DURATRONIC™, FRAME SAW™, INNOVATION THAT WORKS™, JETSTREAM™, MICRO-SET™, MORTEN™, NETWORK™, RIPTIDE™, TRU-MATCH™, WOODWORKER'S CHOICE™, THE AMERICAN WOOD SHOP™ (design) , AUTO-SET™, B.O.S.S.™, BUILDER'S SAW™, CONTRACTOR'S SAW™, DELTA™, DELTACRAFT™, HOMECRAFT™, JET-LOCK™, KICKSTAND™, THE LUMBER COMPANY™ (design), MICRO-SET™, Q3™, QUICKSET II™, QUICKSET PLUS™, SAFEGUARD II™, SANDING CENTER™, SIDEKICK™, UNIFENCE™, UNIGUARD™, UNIRIP™, UNISAW™, VERSA-FEEDER™, TPS™, Emc™.

Trademarks noted with ™ and ® are registered in the United States Patent and Trademark Office and may also be registered in other countries. Las Marcas Registradas con el signo de ™ y ® son registradas por la Oficina de Registros y Patentes de los Estados Unidos y también pueden estar registradas en otros países. Marques déposées, indiquées par la lettre ™ et ®, sont déposées au Bureau des brevets d'invention et marques déposées aux Etats-Unis et pourraient être déposées aux autres pays.