

# Instruction manual

# FINISH NAILER



MODEL DA250B

### ***IMPORTANT***

Please make certain that the person who is to use this equipment carefully reads and understands these instructions before starting operations.

The Model and Serial No. plate is located on the main housing of the tool. Record these numbers in the spaces below and retain for future reference.

Model No. \_\_\_\_\_

Type \_\_\_\_\_

Serial No. \_\_\_\_\_

To learn more about Porter-Cable  
visit our website at:

<http://www.porter-cable.com>

**PORTER-CABLE**  
PROFESSIONAL POWER TOOLS



# PORTER+CABLE

Porter-Cable Corporation  
4825 Highway 45 North  
Jackson, TN 38305

## **GB** ENGLISH EC-DECLARATION OF CONFORMITY

We declare under our sole responsibility that  
this product is in conformity with the  
regulations EN292-2: section 3 of 1992  
EN292-1: section 5 of 1992  
EN1050: 1993  
EN792 13: 2000

## **E** ESPANOL DECLARACION DE CONFORMIDAD "CE"

Declaramos bajo nuestra sola responsabilidad que est e  
producto está en conformidad con las regulaciones  
EN292-2: section 3 of 1992  
EN292-1: section 5 of 1992  
EN1050: 1993  
EN792 13: 2000

## **F** FRANÇAISE DÉCLARATION DE CONFORMITÉ CE

Nous déclarons sous notre propre responsabilitte que  
ce produit est conforme aux reglementations  
EN292-2: section 3 of 1992  
EN292-1: section 5 of 1992  
EN1050: 1993  
EN792 13: 2000

Robert F. Burkholder  
Sr. Vice President of Technology

# PORTER+CABLE

PROFESSIONAL POWER TOOLS

**Date of Manufacture:** \_\_\_\_\_

Fecha de fabricación:, Date de fabrication:

**Serial No:** \_\_\_\_\_

Número de serie:, Nombre d'ordre

## SAFETY GUIDELINES / DEFINITIONS

This manual contains information that is important for you to know and understand. This information relates to protecting YOUR SAFETY and PREVENTING EQUIPMENT PROBLEMS. To help you recognize this information, we use the symbols below. Please read the manual and pay attention to these sections.

- ▲ DANGER** indicates an imminently hazardous situation which, if not avoided, will result in death or serious injury.
- ▲ WARNING** indicates a potentially hazardous situation which, if not avoided, could result in death or serious injury.
- ▲ CAUTION** indicates a potentially hazardous situation which, if not avoided, may result in minor or moderate injury.
- CAUTION** used without the safety alert symbol indicates potentially hazardous situation which, if not avoided, may result in property damage.

## IMPORTANT SAFETY INSTRUCTIONS

### SAVE THESE INSTRUCTIONS!

**▲ WARNING** Improper operation or maintenance of this product could result in serious injury and property damage. Read and understand all warnings and operating instructions before using this tool. When using pneumatic tools, basic safety precautions should always be followed to reduce the risk of personal injury. For additional information visit our website [www.porter-cable.com](http://www.porter-cable.com).

Additional Information regarding the safe and proper operation of air nailer and fastener tools (i.e. a safety video) is available from the International Staple, Nail and Tool Association (ISANTA) ([www.isanta.org](http://www.isanta.org)). Additional Information regarding the safe and proper operation of power tools (i.e. a safety video) is available from the Power Tool Institute, 1300 Sumner Avenue, Cleveland, OH 44115-2851 ([www.powertoolinstitute.com](http://www.powertoolinstitute.com)). Additional Information is also available from the National Safety Council, 1121 Spring Lake Drive, Itasca, IL 60143-3201, the American National Standards Institute ANSI O1.1 Safety Requirements for Woodworking Machines, and the U.S. Department of Labor regulations.

### READ AND FOLLOW ALL INSTRUCTIONS.

**▲ WARNING** There are certain applications for which this tool was designed. Porter-Cable strongly recommends that this tool NOT be modified and/or used for any application other than for which it was designed. If you have any questions relative to its application DO NOT use the tool until you have written Porter-Cable and we have advised you.

Technical Service Manager  
Porter-Cable Corporation  
4825 Highway 45 North  
Jackson, TN 38305

## GENERAL SAFETY RULES

**1. Read and understand tool labels and manual.** Failure to follow warnings could result in **DEATH** or **SERIOUS INJURY**. Fig. 1.

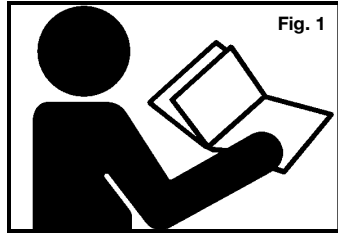

**2. Operator and others in work area MUST wear safety glasses with side shields.** These safety glasses must conform to ANSI Z87.1 requirements (approved glasses have "Z87" printed or stamped on them). Fig. 2.

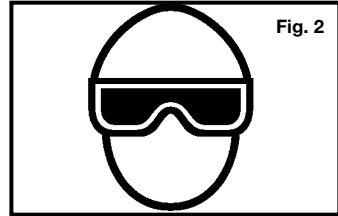

**3. Keep fingers AWAY from trigger when not driving fasteners to avoid accidental firing.** Never carry tool with finger on trigger. In "contact actuation mode", tool will fire a fastener if tool is bumped. Fig. 3.

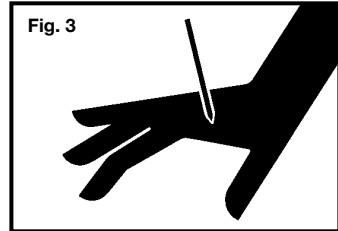

**4. Choice of triggering method is important.** Check manual for triggering options. See "Using the Tool with Different Triggering Options" section of this manual.

**5. Never point tool at yourself or others in work area.** Serious injury or death may occur if the tool is activated. Fig. 4.

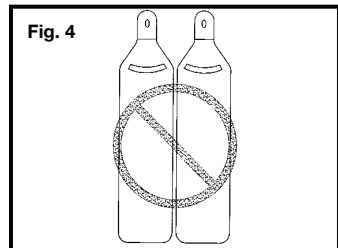

**6. Never use oxygen or other bottled gasses.** Explosion will occur. Never use combustible gases or any other reactive gas as a power source for this tool: explosion and serious personal injury will result. Fig. 5.

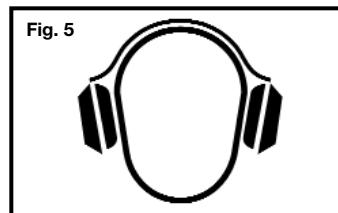

**7. Wear ear protection** to safe-guard against possible hearing loss. Ear protection equipment must conform to ANSI S3.19 requirements. Fig. 5.

**8. Use clean, dry, regulated, compressed air** at 70 to 120 PSI, (4.8 to 8.3 BAR). Fig. 6.

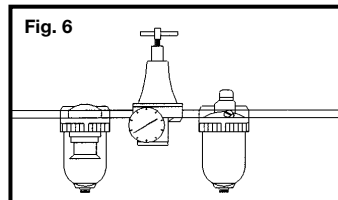

**9. Do not connect tool** to pressure which potentially exceeds 200 PSI (13.7 BAR).

**10. All air line components (hoses, connectors, filters, regulators, etc.)** must be rated for a maximum working pressure of at least 150 PSI (10.3 BAR) or 150% of the maximum system pressure, which ever is greater.

**11. Connect tool to air supply hose** with a coupling that automatically removes all pressure from the tool when the coupling is disconnected. Fig. 7.

**12. Disconnect tool from air supply hose** before doing tool maintenance, clearing a jammed fastener, leaving work area, moving tool to another location, or handing the tool to another person. Fig. 7.

**13. Never use a tool** that is leaking air, has missing or damaged parts, or requires repair. Make sure all screws and caps are securely tightened. Fig. 8.

**14. Never use tool if safety, trigger or springs** are inoperable, missing or damaged. Do not alter or remove safety, trigger, or springs. Make daily inspections for free movement of trigger and safety mechanism. Fig. 8.

**15. Do not use tool without safety warning label.** If label is missing, damaged or unreadable, contact your Porter-Cable Service Center for a replacement. Fig. 9.

**16. Only use parts, fasteners and accessories** approved by Porter-Cable.

**17. Connect tool to air supply before** loading fasteners, to prevent a fastener from being fired during connection. The tool driving mechanism may cycle when tool is connected to the air supply. Fig. 10.

**18. Always assume the tool contains fasteners.** No horseplay. Respect the tool as a working implement. Fig. 11.

**19. Operator and bystanders should wear hard hats** to safeguard against possible injuries. Fig. 12.

**20. Do not load fasteners** with trigger or safety depressed, to prevent unintentional firing of a fastener. Fig. 13

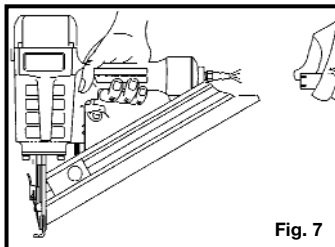

Fig. 7

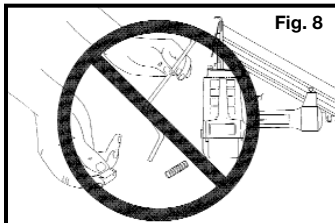

Fig. 8



Fig. 9

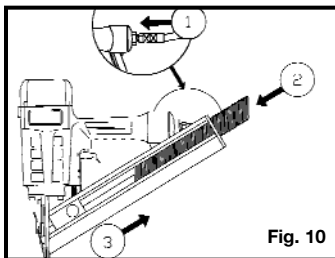

Fig. 10

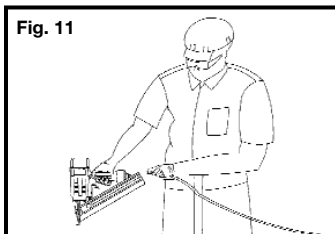

Fig. 11

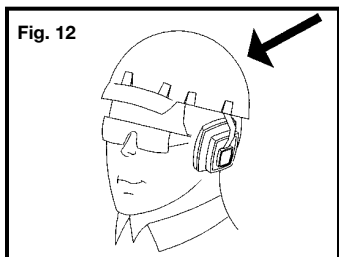

Fig. 12

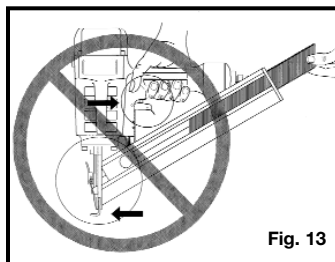

Fig. 13

**21. Remove finger from trigger** when not driving fasteners. Never carry tool with finger on trigger. In “Contact Actuation Mode” tool will fire a fastener if safety is bumped while trigger is depressed. Fig. 14.

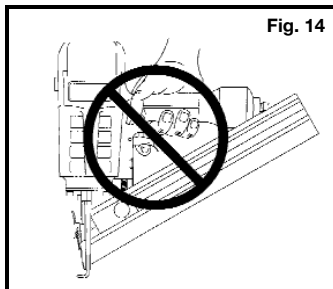

Fig. 14

**22. Do not overreach.** Keep proper footing and balance at all times when using or handling the tool.

**23. Fire fasteners into work surface only:** never into materials too hard to penetrate. Fig. 15.

**24. Grip tool firmly to maintain control while allowing tool to recoil away from work surface as fastener is driven.** In “Contact Actuation Mode” if safety element is allowed to recontact work surface before trigger is released an unwanted fastener will be fired.

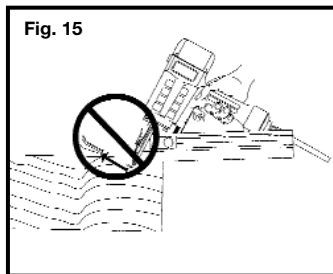

Fig. 15

**25. Do not drive fasteners on top of other fasteners,** or with the tool at too steep an angle: the fasteners can ricochet causing personal injury. Fig. 15.

**26. Do not drive fasteners close to the edge of the workpiece.** The workpiece is likely to split allowing the fastener to fly free or ricochet causing personal injury. Fig. 16.

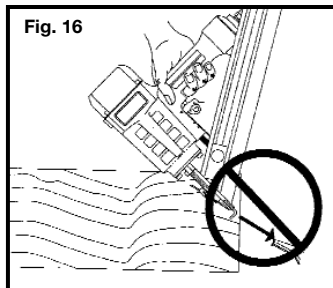

Fig. 16

**27. FOR TOOLS USED IN CONTACT ACTUATION MODE, Do not use on scaffoldings or ladders** or for tasks in which changing location involves the use of scaffoldings, stairs, ladders, and the like. Do not use for specific tasks such as closing boxes or crates or fitting transportation safety systems on vehicles and wagons. Fig. 17.

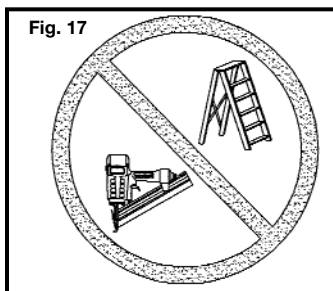

Fig. 17

## TECHNICAL SPECIFICATIONS

Noise level

A - Weighted sound impulse . . .  
power level . . . . . 101 dBA

P - Emission sound pressure  
pressure level . . . . . 93 dBA

Typical Mean

effective Acceleration . . . . . 5.4 m/s<sup>2</sup>

## EMPLOYER'S RESPONSIBILITIES

Employer must enforce compliance with the safety warnings and all other instructions contained in this manual.

Keep this manual available for use by all people assigned to use this tool.

For personal safety and proper operation of this tool, read and understand tool labels and manual. Failure to follow warnings could result in DEATH or SERIOUS INJURY. Read and follow all of these instructions carefully.

## FUNCTIONAL DESCRIPTION

Porter-Cable Model DA250B is a heavy duty pneumatic finish nailer. It is designed to install 15 ga. finish nails of various lengths from 1 $\frac{1}{4}$ " to 2 $\frac{1}{2}$ " long.

**Use approved Porter-Cable fasteners only.**

### POWER SOURCE

This tool is designed to operate on clean, dry, compressed air at regulated pressures between 70 and 120 PSI (Pounds per Square Inch)(4.8 to 8.3 BAR). The preferred system would include a filter, a pressure regulator, and an automatic oiler located as close to the tool as possible, within 15 ft/4.6 m is ideal.

All compressed air contains moisture and other contaminants that are detrimental to internal components of the tool. An air line filter will remove most of these contaminants and significantly prolong the life of the tool. If an in-line oiler is not available: place five or six drops of Porter-Cable Air Tool Oil into the tool's air inlet at the beginning of each workday.

The tool is equipped with a  $\frac{1}{4}$ " male "quick connector". A  $\frac{3}{8}$ " male "quick connector" is available from Porter-Cable and may be used in situations where a  $\frac{1}{4}$ " supply line is not available. The tool must always be connected to the air supply with a coupling such that all pressure is removed from the tool when the coupling is disconnected.

### PREPARING THE TOOL

1. After reading and understanding this entire manual, connect tool to air supply (Fig. 18).
2. Orient a strip of approved fasteners with points down (A) Fig. 19, align, and insert into the magazine "T" slot **points first**.

**⚠ WARNING Do not load fastener strip into magazine backwards.**

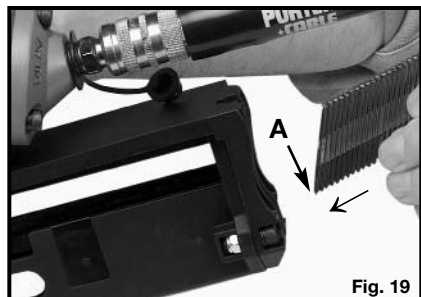

3. Observe fastener icon (A) Fig. 19A. Insert fasteners (B) Fig. 19A with points down (C) Fig. 19A. Slide fasteners forward to the front of the magazine. The magazine will hold two full strips of fasteners.

**IMPORTANT:** Fasteners must point in the same direction as they will be driven.

4. Feed the strip of fasteners into the magazine (“T” slot), until they are past the spring (A) Fig. 20.

5. Pull the follower (B) Fig. 21, all the way to the rear of the magazine and release. The follower will apply pressure to the strip of nails to feed it into the driving mechanism.

6. Adjust directional exhaust deflector (A) Fig. 22, so that the exhaust air blast will be directed away from the operator. The exhaust deflector provides seven detented positions for directing the exhaust blast away from the operator. Grasp the deflector and rotate it to the desired position for the current application.

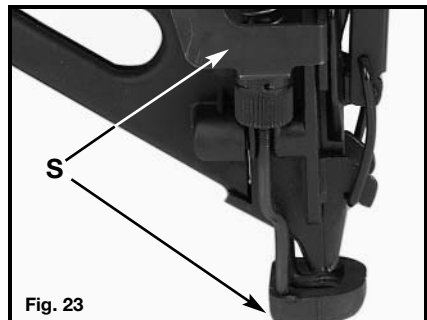
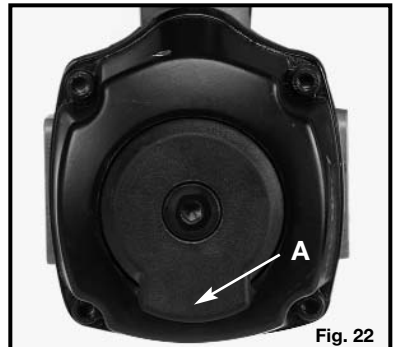
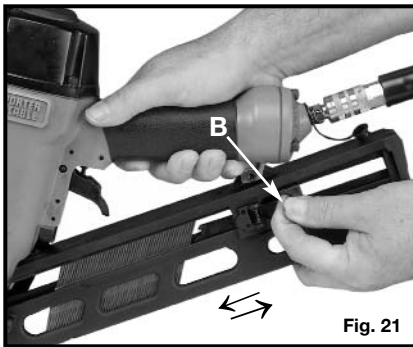
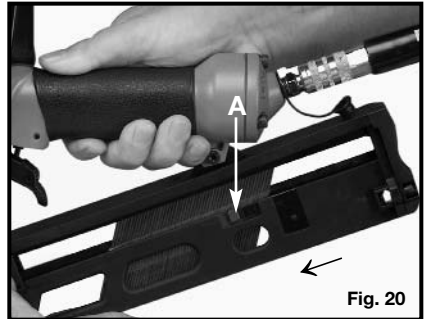
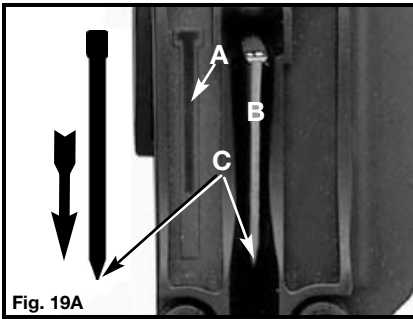



# OPERATING INSTRUCTIONS

## USING THE TOOL WITH DIFFERENT TRIGGERING OPTIONS

Complete all steps of PREPARING THE TOOL before using the tool.

This tool is shipped from the factory with a “**single sequential actuation**” trigger which will limit the tool to firing method number 1 only.

A “**contact actuation**” trigger is available. The “**contact actuation**” trigger allows the tool to be fired in either of two methods described below;

**1. [SINGLE SEQUENTIAL ACTUATION TRIGGER]:** To fire, grip tool firmly to maintain control, position nose of tool onto work surface, push the tool firmly against work surface to **depress safety (S) Fig. 23, and squeeze trigger** to fire a fastener. Allow tool to recoil away from work surface as fastener is driven. This “**single sequential actuation**” method provides the most accurate fastener placement.

-OR-

**2. [CONTACT ACTUATION TRIGGER]:** To fire, grip tool firmly to maintain control, **squeeze and hold trigger**, push the tool firmly against work surface. Allow tool to recoil away from work surface as fastener is driven. If safety element is allowed to recontact work surface before trigger is released an unwanted fastener will be fired. The tool will fire a fastener each time the safety is depressed. This method is known as “**contact actuation**” and allows very fast repetitive fastener placement.

**IMPORTANT:** A “**contact actuation**” trigger is available free-of-charge by calling 1-800-321-9443 in the United States and Canada or 001-731-660-9374 outside the United States and Canada, and providing tool model and serial number. For identification purposes: the **contact actuation** trigger is black and the **single sequential actuation** trigger is red.

**▲WARNING** Disconnect tool from air supply before performing maintenance, clearing a jammed fastener, leaving work area, moving tool to another location, or handing the tool to another person.

**▲WARNING** Clean and inspect tool daily. Carefully check for proper operation of trigger and safety mechanism. **Do Not** use the tool unless both the trigger and the safety mechanism are functional, or if the tool is leaking air or needs any other repair.

The depth to which a fastener is driven is controlled by the depth adjustment knob (A) Fig. 24. The depth of drive is factory adjusted to a nominal setting. Test fire a fastener and check depth. If a change is desired, rotate the adjustment knob (A) Fig. 24. The adjustment knob has detents every  $\frac{1}{4}$  turn. Rotate the knob (A) Fig. 24 clockwise to increase the depth of drive, rotate the knob counterclockwise to decrease the depth of drive. Test fire another fastener and check depth. Repeat as necessary to achieve desired results. The amount of air pressure required will vary depending on the size of the fastener and the material being fastened. Experiment with the air pressure setting to determine the lowest setting that will consistently perform the job at hand. Air pressure in excess of that required can cause premature wear and/or damage to the tool.

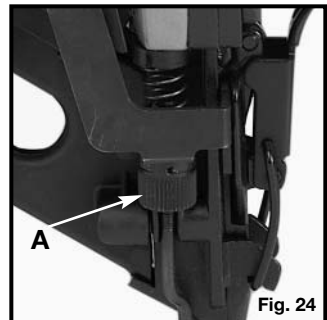
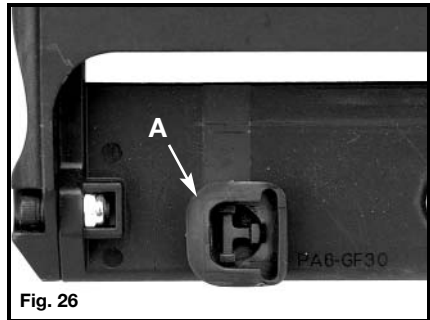
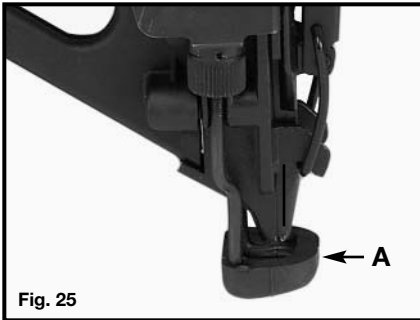

Fig. 24



A rubber nose cushion (A) Fig. 25, is provided to reduce marring of the work surface. The rubber cushion can be removed to provide increased depth-of-drive for toe-nailing applications. When not in use, a storage location is provided for the the rubber cushion on the magazine (A) Fig. 26.

**⚠ WARNING** Disconnect tool from air supply before removing or re-installing rubber cushion.

### CLEARING A JAMMED FASTENER

**⚠ WARNING** Disconnect tool from air supply.

1. Remove any remaining fasteners from the nailer.
  - A. Place finger in recess (A) Fig. 27, and push lever to release follower mechanism.
  - B. Slide the follower to the end of the magazine (refer back to Fig. 21).
  - C. Depress the lever (A) Fig. 28, to release follower mechanism, and slide all remaining fasteners out of the magazine.

**NOTE:** Make sure tip (B) Fig. 28 clears nail strip.

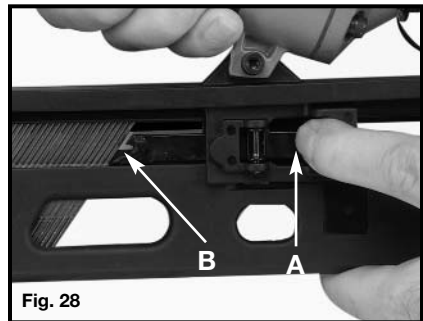
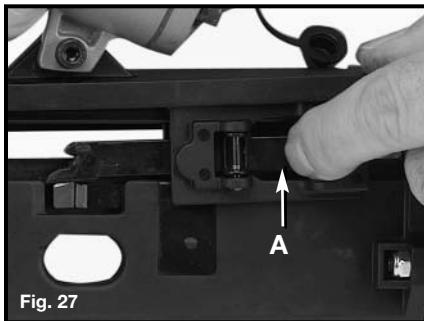

2. Open the quick release latch and hinge the fastener guide plate open (B) Fig. 29.
3. Remove the jammed fastener (see Fig. 30).
4. Close the fastener guide plate and secure with the quick release latch.

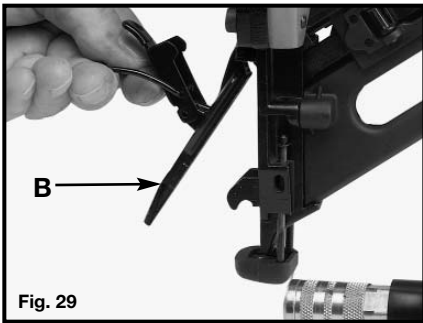

## MAINTENANCE

### CLEAN AND INSPECT DAILY

**⚠ WARNING** Disconnect tool from air supply before cleaning and inspection. Correct all problems before placing the tool back in use.

Wipe tool clean and inspect for wear or damage. Use non-flammable cleaning solutions to wipe exterior of tool only if necessary. **DO NOT SOAK** tool with cleaning solutions. Such solutions can damage internal parts.

Inspect trigger and safety mechanism to assure system is complete and functional: no loose or missing parts, no binding or sticking parts.

Keep all screws tight. Loose screws can cause personal injury or damage tool.

If tool is used without an in-line oiler: place 5 or 6 drops of Porter-Cable Air Tool Oil into the air inlet of the tool at the beginning of each workday.

### SERVICE AND REPAIRS

All quality tools will eventually require servicing or replacement of parts due to wear from normal use. These operations should **ONLY** be performed by either an **AUTHORIZED PORTER-CABLE SERVICE STATION** or a **PORTER-CABLE•DELTA FACTORY SERVICE CENTER**. All repairs made by these agencies are fully guaranteed against defective material and workmanship. We cannot guarantee repairs made or attempted by anyone other than these agencies.

Should you have any questions about your tool, feel free to write us at any time. In any communications, please give all information shown on the nameplate of your tool (model number, type, serial number, etc.).

## TROUBLESHOOTING

**▲WARNING** Disconnect tool from air supply before performing any Service Procedure.

<b>SYMPTOM</b>	<b>PROBLEMS</b>	<b>SOLUTIONS</b>
1. Air leak near top of tool or in trigger area.	Loose screws. Worn or damaged o-rings or seals.	Tighten screws. Install Overhaul Kit.
2. Tool does nothing or operates sluggishly.	Inadequate air supply. Inadequate lubrication. Worn or damaged o-rings or seals.	Verify adequate air supply. Put 5 or 6 drops of oil into air inlet. Install Overhaul Kit.
3. Air leak near bottom of tool.	Loose screws. Worn or damaged o-rings or bumper.	Tighten screws. Install Overhaul Kit.
4. Tool jams frequently.	Incorrect fasteners.  Damaged fasteners. Magazine or nose screws loose. Magazine is dirty. Driver is worn or damaged.	Verify approved fasteners of correct size. Replace w/undamaged fasteners. Tighten screws.  Clean magazine. Install "DRIVER" Maintenance Kit.
5. Other.		Contact a Porter-Cable Service Facility.

## ACCESSORIES

A complete line of accessories is available from your Porter-Cable • Delta Supplier, Porter-Cable • Delta Factory Service Centers, and Porter-Cable Authorized Service Stations. Please visit our Web Site [www.porter-cable.com](http://www.porter-cable.com) for a catalog or for the name of your nearest supplier.

**▲WARNING** Since accessories, other than those offered by Porter-Cable • Delta, have not been tested with this product, use of such accessories could be hazardous. For safest operation, only Porter-Cable • Delta recommended accessories should be used with this product.

### PORTER-CABLE LIMITED ONE YEAR WARRANTY

Porter-Cable warrants its nailing and stapling tools for a period of one year from the date of original purchase. We will repair or replace at our option, any part or parts of the product and accessories covered under this warranty which, after examination, proves to be defective in workmanship or material during the warranty period. For repair or replacement return the complete tool or accessory, transportation prepaid, to your nearest Porter-Cable Service Center or Authorized Service Station. Proof of purchase may be required. This warranty does not apply to O-rings and Driver Blades or to repair or replacement required due to misuse, abuse, normal wear and tear or repairs attempted or made by other than our Service Centers or Authorized Service Stations.

ANY IMPLIED WARRANTY, INCLUDING THE IMPLIED WARRANTIES OF MERCHANTABILITY AND FITNESS FOR A PARTICULAR PURPOSE, WILL LAST ONLY FOR ONE (1) YEAR FROM THE DATE OF PURCHASE.

To obtain information on warranty performance please write to: PORTER-CABLE CORPORATION, 4825 Highway 45 North, Jackson, Tennessee 38305; Attention: Product Service. THE FOREGOING OBLIGATION IS PORTER-CABLE'S SOLE LIABILITY UNDER THIS OR ANY IMPLIED WARRANTY AND UNDER NO CIRCUMSTANCES SHALL PORTER-CABLE BE LIABLE FOR ANY INCIDENTAL OR CONSEQUENTIAL DAMAGES. Some states do not allow limitations on how long an implied warranty lasts or the exclusion or limitation of incidental or consequential damages, so the above limitation or exclusion may not apply to you.

This warranty gives you specific legal rights and you may also have other legal rights which vary from state to state.

# PORTER-CABLE • DELTA SERVICE CENTERS (CENTROS DE SERVICIO DE PORTER-CABLE • DELTA) (CENTRE DE SERVICE PORTER-CABLE • DELTA)

**Parts and Repair Service for Porter-Cable • Delta Power Tools are Available at These Locations  
(Obtenga Refacción de Partes o Servicio para su Herramienta en los Sigüientes Centros de Porter-Cable • Delta)  
(Locations où vous trouverez les pièces de rechange nécessaires ainsi qu'un service d'entretien)**

## ARIZONA

Tempe 85282 (Phoenix)  
2400 West Southern Avenue  
Suite 105  
Phone: (602) 437-1200  
Fax: (602) 437-2200

## CALIFORNIA

Ontario 91761 (Los Angeles)  
3949A East Guasti Road  
Phone: (909) 390-5555  
Fax: (909) 390-5554

San Diego 92111  
7638 Clairemont Blvd.  
Phone: (858) 277-9595  
Fax: (858) 277-9696

San Leandro 94577 (Oakland)  
3039 Teagarden Street  
Phone: (510) 357-9762  
Fax: (510) 357-7939

## COLORADO

Arvada 80003 (Denver)  
8175 Sheridan Blvd., Unit S  
Phone: (303) 487-1809  
Fax: (303) 487-1868

## FLORIDA

Davie 33314 (Miami)  
4343 South State Rd. 7 (441)  
Unit #107  
Phone: (954) 321-6635  
Fax: (954) 321-6638

Tampa 33609  
4538 W. Kennedy Boulevard  
Phone: (813) 877-9585  
Fax: (813) 289-7948

## GEORGIA

Forest Park 30297 (Atlanta)  
5442 Frontage Road,  
Suite 112  
Phone: (404) 608-0006  
Fax: (404) 608-1123

## ILLINOIS

Addison 60101 (Chicago)  
400 South Rohling Rd.  
Phone: (630) 424-8805  
Fax: (630) 424-8895

Woodridge 60517 (Chicago)  
2033 West 75th Street  
Phone: (630) 910-9200  
Fax: (630) 910-0360

## MARYLAND

Elkridge 21075 (Baltimore)  
7397-102 Washington Blvd.  
Phone: (410) 799-9394  
Fax: (410) 799-9398

## MASSACHUSETTS

Franklin 02038 (Boston)  
Franklin Industrial Park  
101E Constitution Blvd.  
Phone: (508) 520-8802  
Fax: (508) 528-8089

## MICHIGAN

Madison Heights 48071 (Detroit)  
30475 Stephenson Highway  
Phone: (248) 597-5000  
Fax: (248) 597-5004

## MINNESOTA

Minneapolis 55429  
5522 Lakeland Avenue North  
Phone: (763) 561-9080  
Fax: (763) 561-0653

## MISSOURI

North Kansas City 64116  
1141 Swift Avenue  
Phone: (816) 221-2070  
Fax: (816) 221-2897

St. Louis 63119

7574 Watson Road  
Phone: (314) 966-8950  
Fax: (314) 968-2790

## NEW YORK

Flushing 11365-1595 (N.Y.C.)  
175-25 Horace Harding Expwy.  
Phone: (718) 225-2040  
Fax: (718) 423-9619

## NORTH CAROLINA

Charlotte 28270  
9129 Monroe Road, Suite 115  
Phone: (704) 841-1176  
Fax: (704) 708-4625

## OHIO

Columbus 43214  
4560 Indianola Avenue  
Phone: (614) 263-0929  
Fax: (614) 263-1238

Cleveland 44125  
8001 Sweet Valley Drive  
Unit #19  
Phone: (216) 447-9000  
Fax: (216) 447-3097

## OREGON

Portland 97230  
4916 NE 122 nd Ave.  
Phone: (503) 252-0107  
Fax: (503) 252-2123

## PENNSYLVANIA

Willow Grove 19090 (Philadelphia)  
520 North York Road  
Phone: (215) 658-1430  
Fax: (215) 658-1433

## TEXAS

Carrollton 75006 (Dallas)  
1300 Interstate 35 N, Suite 112  
Phone: (972) 446-2996  
Fax: (972) 446-8157

## HOUSTON

Houston 77043  
4321 Sam Houston Parkway, West  
Suite 180  
Phone: (713) 983-9910  
Fax: (713) 983-6645

## WASHINGTON

Auburn 98001 (Seattle)  
3320 West Valley HWY, North  
Building D, Suite 111  
Phone: (253) 333-8353  
Fax: (253) 333-9613

Authorized Service Stations are located in many large cities. Telephone **800-487-8665** or **731-541-6042** for assistance locating one. Parts and accessories for Porter-Cable • Delta products should be obtained by contacting any Porter-Cable • Delta Distributor, Authorized Service Center, or Porter-Cable • Delta Factory Service Center. If you do not have access to any of these, call **888-848-5175** and you will be directed to the nearest Porter-Cable • Delta Factory Service Center. Las Estaciones de Servicio Autorizadas están ubicadas en muchas grandes ciudades. Llame al **800-487-8665** o al **731-541-6042** para obtener asistencia a fin de localizar una. Las piezas y los accesorios para los productos Porter-Cable • Delta deben obtenerse poniéndose en contacto con cualquier distribuidor Porter-Cable • Delta, Centro de Servicio Autorizado o Centro de Servicio de Fábrica Porter-Cable • Delta. Si no tiene acceso a ninguna de estas opciones, llame al **888-848-5175** y le dirijirán al Centro de Servicio de Fábrica Porter-Cable • Delta más cercano. Des centres de service agréés sont situés dans beaucoup de grandes villes. Appelez au **800-487-8665** ou au **731-541-6042** pour obtenir de l'aide pour en repérer un. Pour obtenir des pièces et accessoires pour les produits Porter-Cable • Delta, s'adresser à tout distributeur Porter-Cable • Delta, centre de service agréé ou centre de service d'usine Porter-Cable • Delta. Si vous n'avez accès à aucun de ces centres, appeler le **888-848-5175** et on vous dirigera vers le centre de service d'usine Porter-Cable • Delta le plus proche.

## CANADIAN PORTER-CABLE • DELTA SERVICE CENTERS

### ALBERTA

Bay 6, 2520-23rd St. N.E.  
Calgary, Alberta  
T2E 8L2  
Phone: (403) 735-6166  
Fax: (403) 735-6144

### BRITISH COLUMBIA

8520 Baxter Place  
Burnaby, B.C.  
V5A 4T8  
Phone: (604) 420-0102  
Fax: (604) 420-3522

### MANITOBA

1699 Dublin Avenue  
Winnipeg, Manitoba  
R3H 0H2  
Phone: (204) 633-9259  
Fax: (204) 632-1976

### ONTARIO

505 Southgate Drive  
Guelph, Ontario  
N1H 6M7  
Phone: (519) 767-4132  
Fax: (519) 767-4131

### QUÉBEC

1515 Ave.  
St-Jean Baptiste, Suite 160  
Québec, P.Q.  
G2E 5E2  
Phone: (418) 877-7112  
Fax: (418) 877-7123

1447, Begin  
St-Laurent, (Mt), P.Q.  
H4R 1V8  
Phone: (514) 336-8772  
Fax: (514) 336-3505

The following are trademarks of PORTER-CABLE • DELTA (Las siguientes son marcas registradas de PORTER-CABLE • DELTA S.A.) (Les marques suivantes sont des marques de fabricant de la PORTER-CABLE • DELTA): Auto-Set<sup>®</sup>, BAMMER<sup>®</sup>, B.O.S.S.<sup>®</sup>, Builder's Saw<sup>®</sup>, Contractor's Saw<sup>®</sup>, Contractor's Saw II<sup>™</sup>, Delta<sup>™</sup>, DELTACRAFT<sup>™</sup>, DELTAGRAM<sup>™</sup>, Delta Series 2000<sup>™</sup>, DURATRONIC<sup>™</sup>, Emc<sup>2™</sup>, FLEX<sup>®</sup>, Flying Chips<sup>™</sup>, FRAME SAW<sup>™</sup>, Grip Vac<sup>™</sup>, Homecraft<sup>™</sup>, INNOVATION THAT WORKS<sup>™</sup>, Jet-Lock<sup>™</sup>, JETSTREAM<sup>™</sup>, "kickstand", LASERLOC<sup>™</sup>, MICRO-SET<sup>™</sup>, Micro-Set<sup>™</sup>, MIDI LATHE<sup>™</sup>, MORTEN<sup>™</sup>, NETWORK<sup>™</sup>, OMNIJIG<sup>™</sup>, POCKET CUTTER<sup>™</sup>, PORTA-BAND<sup>™</sup>, PORTA-PLANE<sup>™</sup>, PORTER-CABLE<sup>®</sup> & (design), PORTER-CABLE<sup>®</sup> PROFESSIONAL POWER TOOLS, PORTER-CABLE REDEFINING PERFORMANCE<sup>™</sup>, Posi-Matic<sup>®</sup>, Q-3<sup>®</sup> & (design), QUICKSAND<sup>®</sup> & (design), QUICKSET<sup>™</sup>, QUICKSET II<sup>™</sup>, QUICKSET PLUS<sup>™</sup>, RIPTIDE<sup>™</sup> & (design), SAFE GUARD II<sup>®</sup>, SAFE-LOC<sup>®</sup>, Sanding Center<sup>®</sup>, SANDTRAP<sup>®</sup> & (design), SAW BOSS<sup>™</sup>, Sawbuck<sup>™</sup>, Sidekick<sup>™</sup>, SPEED-BLOC<sup>™</sup>, SPEEDMATIC<sup>™</sup>, SPEEDTRONIC<sup>™</sup>, STAIR EASE<sup>™</sup>, The American Woodshop<sup>®</sup> & (design), The Lumber Company<sup>®</sup> & (design), THE PROFESSIONAL EDGE<sup>™</sup>, THE PROFESSIONAL SELECT<sup>™</sup>, THIN-LINE<sup>™</sup>, TIGER<sup>™</sup>, TIGER CUB<sup>™</sup>, TIGER SAW<sup>™</sup>, TORQBUSTER<sup>™</sup>, TORQ-BUSTER<sup>™</sup>, TRU-MATCH<sup>™</sup>, TWIN-LITE<sup>™</sup>, UNIGUARD<sup>™</sup>, Unifence<sup>™</sup>, UNIFEEDER<sup>™</sup>, Unihead<sup>™</sup>, Uniplane<sup>™</sup>, Unirip<sup>™</sup>, Unisaw<sup>™</sup>, Univise<sup>™</sup>, Versa-Feeder<sup>™</sup>, VERSA-PLANE<sup>™</sup>, WHISPER SERIES<sup>™</sup>, WOODWORKER'S CHOICE<sup>™</sup>.

Trademarks noted with <sup>™</sup> and ® are registered in the United States Patent and Trademark Office and may also be registered in other countries. Las Marcas Registradas con el signo de <sup>™</sup> y ® son registradas por la Oficina de Registros y Patentes de los Estados Unidos y también pueden estar registradas en otros países. Marques déposées, indiquées par la lettre <sup>™</sup> et ®, sont déposées au Bureau des brevets d'invention et marques déposées aux Etats-Unis et pourraient être déposées aux autres pays.

Printed in U.S.A. PC-0104-151