

Double Insulated Drain Cleaner

Instruction manual

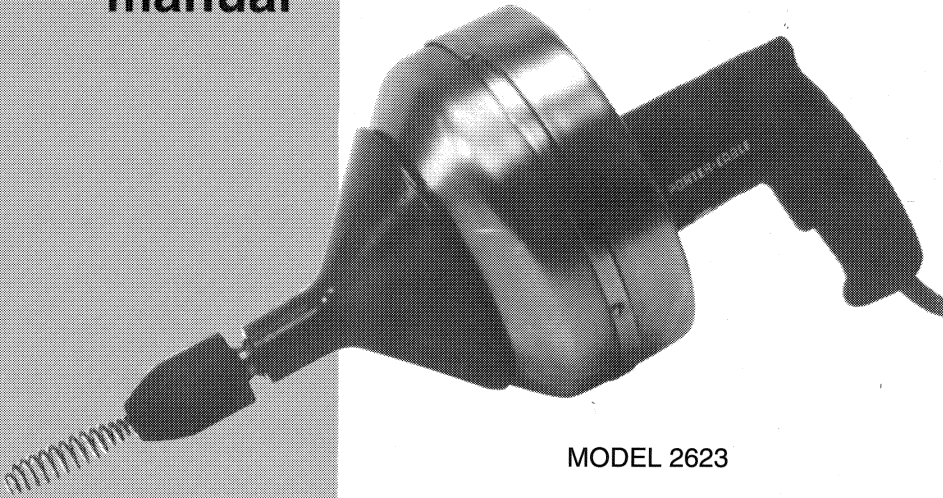

MODEL 2623

IMPORTANT

Please make certain that the person who is to use this equipment carefully reads and understands these instructions before starting operations.

The Model and Serial No. plate is located on the main housing of the tool. Record these numbers in the spaces below and retain for future reference.

Model No. _____

Type _____

Serial No. _____

PORTER-CABLE
PROFESSIONAL POWER TOOLS

Part No. 876869-394

IMPORTANT SAFETY INSTRUCTIONS

WARNING: When using electric tools, basic safety precautions should always be followed to reduce the risk of fire, electric shock and personal injury, including the following:

READ AND FOLLOW ALL INSTRUCTIONS.

There are certain applications for which this tool was designed. Porter-Cable strongly recommends that this tool NOT be modified and/or used for any application other than for which it was designed. If you have any questions relative to its application DO NOT use the tool until you have written Porter-Cable and we have advised you.

Manager of Product Engineering
Porter-Cable Corporation
4825 Highway 45 North
P.O. Box 2468
Jackson, TN 38302-2468

POLARIZED PLUGS: To reduce the risk of electric shock, this equipment has a polarized plug (one blade is wider than the other). This plug will fit in a polarized outlet only one way. If the plug does not fit fully in the outlet, reverse the plug. If it still does not fit, contact a qualified electrician to install the proper outlet. Do not change the plug in any way.

- 1. KEEP WORK AREA CLEAN.** Cluttered areas and benches invite injuries.
- 2. AVOID DANGEROUS ENVIRONMENT.** Don't expose power tools to rain. Don't use power tools in damp or wet locations. Keep area well lit. Avoid chemical or corrosive environment. Do not use tool in presence of flammable liquids or gases.



THIS SYMBOL DENOTES DO NOT EXPOSE TO RAIN OR USE IN DAMP LOCATIONS

CE SIGNE EST L'INDICATIONS DE NE PAS EXPOSER A LA PLUIE ET NE PAS UTILISER DANS LES EMPLACEMENTS HUMIDES

- 3. GUARD AGAINST ELECTRIC SHOCK.** Prevent body contact with grounded surfaces. For example: pipes, radiators, ranges, refrigerator enclosures.
- 4. KEEP CHILDREN AWAY.** Do not let visitors contact tool or extension cord. All visitors should be kept away from work area.
- 5. STORE IDLE TOOLS.** When not in use, tools should be stored in dry, and high or locked-up place — out of reach of children.
- 6. DON'T FORCE TOOL.** It will do the job better and safer at the rate for which it was intended.
- 7. USE RIGHT TOOL.** Don't force small tool or attachment to do the job of a heavy duty tool. Don't use tool for purpose not intended — for example — do not use a circular saw for cutting tree limbs or logs.
- 8. DRESS PROPERLY.** Do not wear loose clothing or jewelry. Loose clothing, draw strings and jewelry can be caught in moving parts. Rubber gloves and non-skid footwear are recommended when working outdoors. Wear protective hair covering to contain long hair.

9. USE SAFETY GLASSES. Wear safety glasses or goggles while operating power tools. Also face or dust mask if operation creates dust. All persons in the area where power tools are being operated should also wear safety glasses and face or dust mask.

10. DON'T ABUSE CORD. Never carry tool by cord or yank it to disconnect from receptacle. Keep cord from heat, oil, and sharp edges. Have damaged or worn power cord and strain reliever replaced immediately. **DO NOT ATTEMPT TO REPAIR POWER CORD.**

11. SECURE WORK. Use clamps or a vise to hold work. It's safer than using your hand and it frees both hands to operate tool.

12. DON'T OVERREACH. Keep proper footing and balance at all times.

13. MAINTAIN TOOLS WITH CARE. Keep tools sharp and clean for better and safer performance. Follow instructions for lubricating and changing accessories. Inspect tool cords periodically and if damaged, have repaired by authorized service facility. Inspect extension cords periodically and replace if damaged. Have all worn, broken or lost parts replaced immediately. Keep handles dry, clean and free from oil and grease.

14. DISCONNECT TOOLS. When not in use, before servicing, and when changing accessories such as blades, bits, cutters, etc.

15. REMOVE ADJUSTING KEYS AND WRENCHES. Form habit of checking to see that keys and adjusting wrenches are removed from the tool before turning it on.

16. AVOID UNINTENTIONAL STARTING. Do not carry a plugged-in tool with finger on switch. Be sure switch is off when plugging in. Keep hands, body and clothing clear of blades, bits, cutters, etc. when plugging in the tool.

17. OUTDOOR USE EXTENSION CORDS. When tool is used outdoors, use only extension cords marked "Suitable for use with outdoor appliances - store indoors when not in use."

18. STAY ALERT. Watch what you are doing. Use common sense. Do not operate tool when you are tired or while under the influence of medication, alcohol or drugs.

19. CHECK DAMAGED PARTS. Before further use of the tool, a guard or other part that is damaged should be carefully checked to determine that it will operate properly and perform its intended function. Check for alignment of moving parts, binding of moving parts, breakage of parts, mounting, and any other conditions that may affect its operation. A guard or other part that is damaged should be properly repaired or replaced by an authorized service center unless otherwise indicated elsewhere in this instruction manual. Have defective switches replaced by authorized service center. Do not use tool if switch does not turn it on and off.

20. WEAR EAR PROTECTION to safeguard against possible hearing loss.

SAVE THESE INSTRUCTIONS

REPLACEMENT PARTS

When servicing, use only identical replacement parts.

ADDITIONAL SAFETY RULES FOR DRAIN CLEANER

- 1. USE ONLY AS A DRAIN CLEANER.**
- 2. USE ONLY APPROVED ACCESSORIES.**
- 3. USE ON GROUND FAULT** interrupted circuit only.
- 4. NEUTRALIZE CHEMICAL** drain cleaners before using Model 2623 Drain Cleaner. Chemical drain cleaners can cause a health hazard.
- 5. WEAR SAFETY GLASSES.**
- 6. WEAR RUBBER GLOVE** inserts and rubber boots when using the Drain Cleaner.
- 7. WEAR LEATHER GLOVES** when handling the Drain Cleaner cable.
- 8. DO NOT HANDLE CABLE** with bare hand.
- 9. OPERATE DRAIN CLEANER** with one person only. Keep everyone else clear of work area.
- 10. DO NOT IMMERSE** tool in a liquid.
- 11. VERIFY DIRECTION OF ROTATION** is correct for operation to be performed before starting tool.
- 12. DO NOT ATTEMPT** to change direction of rotation while switch is ON. To do so may damage interlock feature built into switch. Be sure switch is OFF and motor has completely stopped.
- 13. KEEP DRAIN CLEANER** as close to the drain opening as possible to prevent the cable from whipping or binding.
- 14. DO NOT OPERATE** Drain Cleaner with cable outside of the drain pipe.
- 15. NEVER FORCE** a tool and cable into a pipe line blockage. Let the cutter do the work.
- 16. REVERSE MOTOR ROTATION** to free a jammed cable.
- 17. CLEAN CABLE THOROUGHLY AFTER USE.**
- 18. REMOVE COILED CABLE** from drum before disassembling drum.

MOTOR

Many Porter-Cable tools will operate on either D.C., or single phase 25 to 60 cycle A.C. current and voltage within plus or minus 5 percent of that shown on the specification plate on the tool. Several models, however, are designed for A.C. current only. Refer to the specification plate on your tool for proper voltage and current rating.

CAUTION: Do not operate your tool on a current on which the voltage is not within correct limits. Do not operate tools rated A.C. only on D.C. current. To do so may seriously damage the tool.

EXTENSION CORD SELECTION

If an extension cord is used, make sure the conductor size is large enough to prevent excessive voltage drop which will cause loss of power and possible motor damage. A table of recommended extension cord sizes will be found on page 5. This table is based on limiting line voltage drop to 5 volts (10 volts for 230 volts) at 150% of rated amperes.

If an extension cord is to be used outdoors it must be marked with the suffix W-A following the cord type designation. For example — SJTW-A to indicate it is acceptable for outdoor use.

RECOMMENDED EXTENSION CORD SIZES FOR USE WITH PORTABLE ELECTRIC TOOLS

		Length of Cord in Feet									
		115V	25 Ft.	50 Ft.	100 Ft.	150 Ft.	200 Ft.	250 Ft.	300 Ft.	400 Ft.	500 Ft.
Nameplate Ampere Rating	230V	50 Ft.	100 Ft.	200 Ft.	300 Ft.	400 Ft.	500 Ft.	600 Ft.	800 Ft.	1000 Ft.	
	0-2	18	18	18	16	16	14	14	12	12	
	2-3	18	18	16	14	14	12	12	10	10	
	3-4	18	18	16	14	12	12	10	10	8	
	4-5	18	18	14	12	12	10	10	8	8	
	5-6	18	16	14	12	10	10	8	8	6	
	6-8	18	16	12	10	10	8	6	6	6	
	8-10	18	14	12	10	8	8	6	6	4	
	10-12	16	14	10	8	8	6	6	4	4	
	12-14	16	12	10	8	6	6	6	4	2	
	14-16	16	12	10	8	6	6	4	4	2	
	16-18	14	12	8	8	6	4	4	2	2	
18-20	14	12	8	6	6	4	4	2	2		

OPERATING INSTRUCTIONS

FOREWORD

The Model 2623 Drain Cleaner is designed to clean drain pipes that are between 1¼" and 2" in diameter. A 5/16" diameter cable is supplied with the Drain Cleaner. A variety of accessory cables and heads are listed in the back of this manual. The following chart shows the recommended cable diameters for cleaning various size drains.

INSIDE DIAMETER OF DRAIN	RECOMMENDED CABLE DIAMETER
1¼"	¼" or 5/16"
1½"	5/16" or 3/8"
2"	5/16" or 3/8"

DO NOT use a cable in a larger drain than recommended; damage to the cable could result.

DRAIN CLEANER CHUCK

The Drain Cleaner is equipped with a KEYLESS type chuck. To operate chuck, grasp the outer body of the chuck with your hand and twist it counterclockwise (see Fig. 1) to OPEN; twist clockwise to CLOSE.

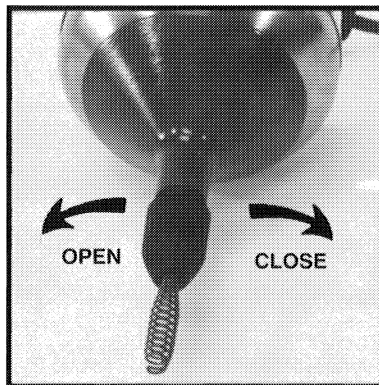

Fig. 1

INSTALL CABLE INTO DRUM

CAUTION: DISCONNECT DRAIN CLEANER FROM POWER SOURCE.

1. Use a vise or a pair of pliers to make a bend in the tail end of the cable. This bend should be approximately 30°, and located about 1" from the tail end of the cable (see Fig. 2).

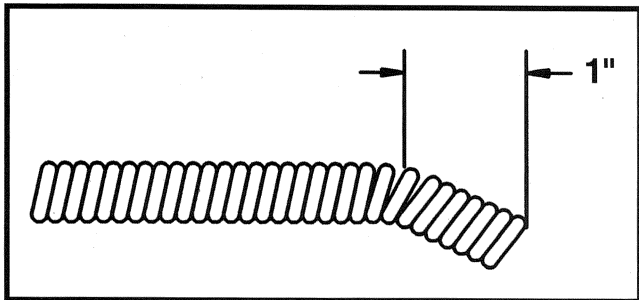

Fig. 2

2. Turn Drain Cleaner chuck counterclockwise to open.
3. Insert tail end of cable through chuck jaws and into drum. Use short (10" to 12" at a time), thrusts to feed remainder of cable into drum.
4. Turn chuck body clockwise to close chuck jaws, securing the cable in the drum.

TO START AND STOP DRAIN CLEANER

CAUTION: Make sure TRIGGER SWITCH (Fig. 3), is OFF. Make sure power circuit voltage is the same as that shown on the specification plate of the Drain Cleaner. Make sure cable is fully retracted into drum. Connect Drain Cleaner to power circuit.

1. Squeeze TRIGGER SWITCH (Fig. 3), to start motor. Release trigger switch to stop motor. As the trigger switch is squeezed, the motor speed increases.

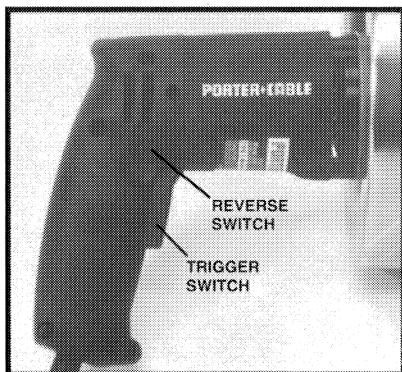

Fig. 3

2. The REVERSING SWITCH (Fig. 3), changes the direction of rotation. FORWARD rotation is used when feeding the cable into the drain and when removing cable from drain. REVERSE rotation is ONLY used to free the cable if it gets hung up.

FOR CLOCKWISE ROTATION: release trigger switch and allow drum to stop rotating, push the reversing switch toward the left side of the Drain Cleaner.

FOR COUNTERCLOCKWISE ROTATION: release trigger switch and allow drum to stop rotating, push the reversing switch toward the right side of the Drain Cleaner.

CAUTION: Allow drum to completely stop rotating before changing direction of rotation.

NOTE: Never attempt to change direction of rotation while switch is ON. To do so, may damage switch interlock feature.

HOW TO HOLD THE DRAIN CLEANER

Place one hand on the pistol grip handle at the rear of the tool and the other hand on the hand guard at the front of the tool (see Fig. 4). KEEP CLEAR of the rotating drum while tool is in operation.

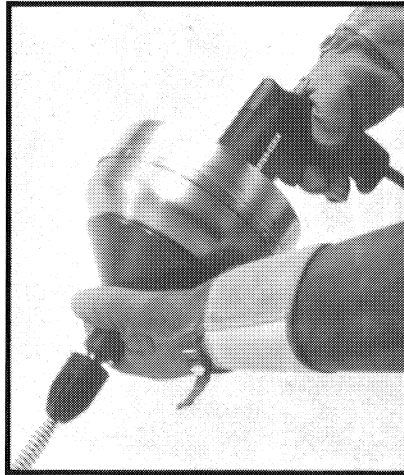

Fig. 4

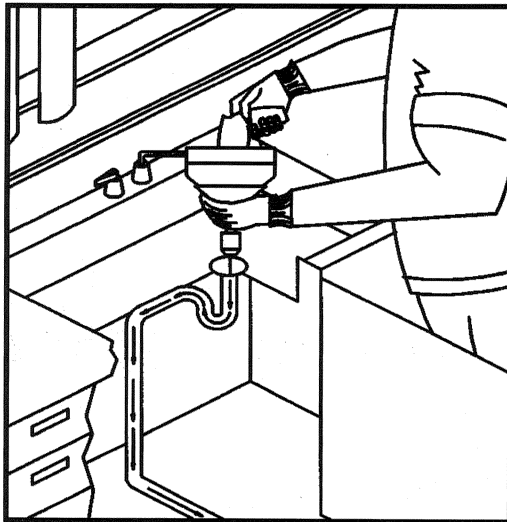

Fig. 5

INSERT CABLE INTO DRAIN

1. Verify that switch is set for FORWARD rotation, and that the power source matches the requirements on the tool's specification plate. Connect Drain Cleaner to power source.
2. Open chuck and pull out approximately one foot of cable.
3. Close chuck lightly.
4. Operate Drain Cleaner at low speed while slowly feeding cable into drain.

NOTE: If cable binds; STOP the tool immediately. Set switch for reverse rotation. Operate motor slowly while pulling back lightly on the Drain Cleaner to free the cable. DO NOT operate tool in reverse for extended periods. Extended reverse operation can damage the cable.

5. Continue to operate tool at low speed while repeating steps 2 through 4 to feed additional cable into the drain until the obstruction is cleared.

REMOVE CABLE FROM DRAIN

1. Tighten chuck firmly. Set switch for FORWARD rotation.
2. Operate tool slowly while pulling back to remove approximately one foot of cable from the drain.
3. STOP the tool. Carefully wipe the exposed cable with a dry rag. Open chuck and push the exposed cable back into the drum. Tighten chuck.
4. Repeat Steps 2 and 3 until entire cable is back in the drum.

TOILET GUIDE

A Toilet Guide and Holder are supplied with the Drain Cleaner kit. This accessory provides a guide to help start the drain cleaner cable into a toilet (see Fig. 6).

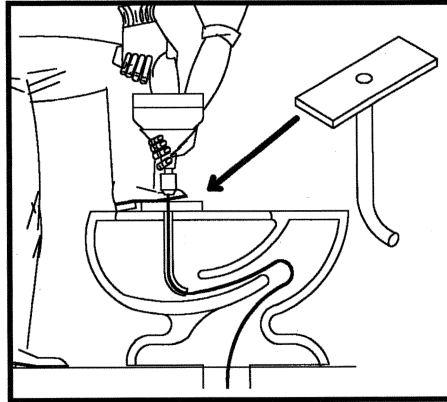

Fig. 6

STORAGE

The cable should always be thoroughly cleaned and oiled prior to storing the Drain Cleaner.

CAUTION: DISCONNECT DRAIN CLEANER FROM POWER SOURCE.

1. Open the chuck and remove the entire cable from the drum.
2. Wash cable thoroughly and allow to dry.
3. Use an oily rag to coat cable with oil.
4. Reinstall the cable into the drum.

MAINTENANCE

KEEP TOOL CLEAN

Periodically blow out all air passages with dry compressed air. All plastic parts should be cleaned with a soft damp cloth. NEVER use solvents to clean plastic parts. They could possibly dissolve or otherwise damage the material.

CAUTION: Wear safety glasses while using compressed air.

FAILURE TO START

Should your tool fail to start, check to make sure the prongs on the cord plug are making good contact in the outlet. Also, check for blown fuses or open circuit breakers in the line.

BRUSH INSPECTION AND LUBRICATION

For your continued safety and electrical protection, brush inspection and replacement on this tool should ONLY be performed by an AUTHORIZED PORTER-CABLE SERVICE STATION or a PORTER-CABLE SERVICE CENTER.

At approximately 100 hours of use, take or send your tool to your nearest Authorized Porter-Cable Service Station to be thoroughly cleaned and inspected; worn parts replaced, when necessary; relubricated with fresh lubricant, if required; reassembled with new brushes; and performance tested.

Any loss of power before the above maintenance check may indicate the need for immediate servicing of your tool. DO NOT CONTINUE TO OPERATE TOOL UNDER THIS CONDITION. If proper operating voltage is present, return your tool to the Service Station for immediate service.

SERVICE AND REPAIRS

All quality tools will eventually require servicing or replacement of parts due to wear from normal use. These operations, including brush inspection and replacement, should ONLY be performed by either an AUTHORIZED PORTER-CABLE SERVICE STATION or a PORTER-CABLE SERVICE CENTER. All repairs made by these agencies are fully guaranteed against defective material and workmanship. We cannot guarantee repairs made or attempted by anyone other than these agencies.

Should you have any questions about your tool, feel free to write us at any time. In any communications, please give all information shown on the nameplate of your tool (model number, type, serial number, etc.).

ACCESSORIES

The testing of this tool has been accomplished with the following accessories. For safest operation, it is recommended that only these accessories be used with this product.

WARNING: Since accessories other than those listed have not been tested with this product, use of such accessories could be hazardous.

26230	Replacement Chuck
26231	Toilet Guide Tube and Holder
26233	Short General Purpose Drop Head Tool
26234	General Purpose Drop Head Tool
26235	Drill Point Drop Head Tool
26236	Finishing Type Drop Head Tool
26237	Drop Head Extension
26238	1/4" x 25' Type E Cable
26239	1/4" x 35' Type E Cable
26240	5/16" x 25' Type E Cable
26241	3/8" x 25' Type IC Cable
26242	3/8" x 35' Type IC Cable
26243	3/8" x 25' Type EIC Cable
26244	3/8" x 35' Type EIC Cable
26245	5/16" x 25' Type EIC Cable
26246	5/16" x 35' Type EIC Cable

Cable Type Designations:

E = Expanded End

IC = Wire Reinforced (uses Drop Head Fitting)

EIC = Wire Reinforced with Expanded End

PORTER-CABLE ONE YEAR WARRANTY

Porter-Cable warrants its Professional Power tools for a period of one year from the date of original purchase. We will repair or replace at our option, any part or parts of the product and accessories covered under this warranty which examination proves to be defective in workmanship or material during the warranty period. For repair or replacement return the complete tool or accessory, transportation prepaid, to your nearest Porter-Cable Service Center or Authorized Service Station as listed under "TOOLS-ELECTRIC" in the Yellow Pages of your telephone directory. Proof of purchase may be required. This warranty does not apply to repair or replacement required due to misuse, abuse, normal wear and tear or repairs attempted or made by other than our Service Centers or Authorized Service Stations.

To obtain information on warranty performance please write to: PORTER-CABLE CORPORATION, 4825 Highway 45 North, P.O. Box 2468, Jackson, Tennessee 38302-2468; Attention: Product Service. The foregoing obligation is Porter-Cable's sole liability under this or any implied warranty and under no circumstances shall Porter-Cable be liable for any incidental or consequential damages. Some states do not allow limitations on how long an implied warranty lasts on the exclusion or limitation of incidental or consequential damages, so the above limitation or exclusion may not apply to you.

This warranty gives you specific legal rights and you may also have other legal rights which vary from state to state.

PORTER-CABLE SERVICE CENTERS

Parts and Repair Service for Porter-Cable Power Tools are Available at These Locations

CALIFORNIA

City of Industry 91745 (Los Angeles)
1305 John Reed Court
Phone: (818) 333-3566
Fax: (818) 330-5900

San Leandro 94577 (Oakland)
3039 Teagarden Street
Phone: (510) 357-9762
Fax: (510) 357-7939

COLORADO

Denver 80204
2561 West 8th Avenue
Phone: (303) 892-6113
Fax: (303) 595-0358

FLORIDA

Hialeah 33014 (Miami)
16373-75 NW 57th Ave.
Phone: (305) 624-2523
Fax: (305) 628-2654

Tampa 33609
4538 W. Kennedy Boulevard
Phone: (813) 877-9585
Fax: (813) 289-7948

GEORGIA

Morrow 30260 (Atlanta)
1286 Citizens Parkway
Suite C
Phone: (404) 961-0900
Fax: (404) 961-8624

ILLINOIS

Addison 60101 (Chicago)
311 Laura Drive
Phone: (708) 628-6100
Fax: (708) 628-0023

MARYLAND

Baltimore 21227
7397 Washington Blvd.
Suite #102
Phone: (410) 799-9394
Fax: (410) 799-9398

MASSACHUSETTS

Franklin 02038 (Boston)
Franklin Industrial Park
101E Constitution Blvd.
Phone: (508) 520-8802
Fax: (508) 528-8089

MICHIGAN

Southfield 48075 (Detroit)
18650 W. Eight Mile Road
Phone: (313) 569-4333
Fax: (313) 569-4337

MINNESOTA

Minneapolis 55429
4315 68th Avenue North
Phone: (612) 561-9080
Fax: (612) 561-0653

MISSOURI

North Kansas City 64116
1141 Swift Avenue
P.O. Box 12393
Phone: (816) 221-2070
Fax: (816) 221-2897

St. Louis 63119
7574 Watson Road
Phone: (314) 968-8950
Fax: (314) 968-2790

NEW YORK

Flushing 11365-1595 (N.Y.C.)
175-25 Horace Harding Expwy.
Phone: (718) 225-2040
Fax: (718) 423-9619

NORTH CAROLINA

Charlotte 28209
4303-B South Boulevard
Phone: (704) 525-4410
Fax: (704) 525-0618

OHIO

Columbus 43214
4560 Indianola Avenue
Phone: (614) 263-0929
Fax: (614) 263-1238

Cleveland 44125
8001 Sweet Valley Dr.
Unit #18
Phone: (216) 447-9030
Fax: (216) 447-3097

PENNSYLVANIA

Philadelphia 19154
12285 McNulty Road
Phone: (215) 677-7800
Fax: (215) 677-9908

TEXAS

Dallas 75220
10720 N. Stemmons Freeway
Phone: (214) 353-2996
Fax: (214) 350-3943

Houston 77092
5201 Mitchelldale B-9
Phone: (713) 682-0334
Fax: (713) 682-4867

WASHINGTON

Renton 98055 (Seattle)
268 Southwest 43rd Street
Phone: (206) 251-6680
Fax: (206) 251-9337

Authorized Service Stations are located in all large cities, For the one nearest you, see the classified section in your phone book (under "Tools-Electric").

DELTA SERVICE CENTRES

(CENTRES D'ENTRETIEN DELTA)

ALBERTA

#10 6320 11th Street S.E.
Calgary, Alberta
T2H 2L7
Phone: (403) 255-3530
Fax: (403) 258-0767

BRITISH COLUMBIA

8520 Baxter Place
Burnaby, B.C.
V5A 4T8
Phone: (604) 420-0102
Fax: (604) 420-3522

MANITOBA

1699 Dublin Avenue
Winnipeg, Manitoba
R3H 0H2
Phone: (204) 633-9259
Fax: (204) 632-1976

ONTARIO

644 Imperial Road
Guelph, Ontario
N1H 6M7
Phone: (519) 836-2840
Fax: (519) 836-9352

QUÉBEC

40 West Pearce St.
Unit #2
Richmond Hill, Ontario
L4B 1E3
Phone: (416) 771-6111
Fax: (416) 771-6831

523 Rue Deslauriers
St. Laurent, (Montréal) P.Q.
H4N 1W2
Phone: (514) 336-8772
Fax: (514) 336-3505

Suite 202
2022 Rue Lavoisier
Ste. Foy, Québec, Québec
G1N 4L5
Phone: (418) 681-7305
Fax: (418) 681-1695

Authorized Service Stations are located in all large cities, For the one nearest you, see the classified section in your phone book (under "Tools-Electric").

PORTER-CABLE®, HAMMER-HEAD®, OMNIJIG®, PORTA-BAND®, PORTA-PLANE®, VERSA-PLANE®, SAW BOSS®, SPEED-BLOC®, SPEEDMATIC®, SPEEDTRONIC®, STAIR-EASE®, DURATRONIC™, LASERLOC™, MICRO-SET™, MORTEN™, POCKET CUTTER™, PRODUCTION CLASS™, QUICKSAND™, SANDTRAP™, THE PROFESSIONAL EDGE™, TIGER™ SAW, TIGER CUB™, TRU-MATCH™ are trademarks of Porter-Cable Corporation.

Copyright© 1992 Porter-Cable Corporation

Printed in U.S.A.